

ETSI EN 300 440 V2.2.1 (2018-07)



**Short Range Devices (SRD);
Radio equipment to be used in
the 1 GHz to 40 GHz frequency range;
Harmonised Standard covering the essential requirements for
access to radio spectrum
of article 3.2 of Directive 2014/53/EU**

Reference

REN/ERM-TG28-522551

Keywords

harmonised standard, radio, SRD, testing

ETSI

650 Route des Lucioles
F-06921 Sophia Antipolis Cedex - FRANCE

Tel.: +33 4 92 94 42 00 Fax: +33 4 93 65 47 16

Siret N° 348 623 562 00017 - NAF 742 C
Association à but non lucratif enregistrée à la
Sous-Préfecture de Grasse (06) N° 7803/88

Important notice

The present document can be downloaded from:

<http://www.etsi.org/standards-search>

The present document may be made available in electronic versions and/or in print. The content of any electronic and/or print versions of the present document shall not be modified without the prior written authorization of ETSI. In case of any existing or perceived difference in contents between such versions and/or in print, the only prevailing document is the print of the Portable Document Format (PDF) version kept on a specific network drive within ETSI Secretariat.

Users of the present document should be aware that the document may be subject to revision or change of status.

Information on the current status of this and other ETSI documents is available at

<https://portal.etsi.org/TB/ETSIDeliverableStatus.aspx>

If you find errors in the present document, please send your comment to one of the following services:

<https://portal.etsi.org/People/CommitteeSupportStaff.aspx>

Copyright Notification

No part may be reproduced or utilized in any form or by any means, electronic or mechanical, including photocopying and microfilm except as authorized by written permission of ETSI.

The content of the PDF version shall not be modified without the written authorization of ETSI.

The copyright and the foregoing restriction extend to reproduction in all media.

© ETSI 2018.

All rights reserved.

DECT™, **PLUGTESTS™**, **UMTS™** and the ETSI logo are trademarks of ETSI registered for the benefit of its Members.

3GPP™ and **LTE™** are trademarks of ETSI registered for the benefit of its Members and of the 3GPP Organizational Partners.

oneM2M logo is protected for the benefit of its Members.

GSM® and the GSM logo are trademarks registered and owned by the GSM Association.

Contents

Intellectual Property Rights	8
Foreword.....	8
Modal verbs terminology	8
Introduction	9
1 Scope	10
2 References	11
2.1 Normative references	11
2.2 Informative references	11
3 Definitions, symbols and abbreviations	12
3.1 Definitions	12
3.2 Symbols	14
3.3 Abbreviations.....	14
4 Technical requirements specifications	15
4.1 Environmental profile	15
4.2 Transmitter requirements	15
4.2.1 Transmitter measurement requirements	15
4.2.1.1 Applicability	15
4.2.1.2 Methods of measurement and limits for transmitter parameters.....	15
4.2.2 Equivalent isotropically radiated power (e.i.r.p.)	16
4.2.2.1 Applicability	16
4.2.2.2 Description	16
4.2.2.3 Method of measurement	16
4.2.2.3.0 General requirements	16
4.2.2.3.1 Non spread spectrum transmitters with a -6 dB bandwidth of up to 20 MHz and spread spectrum transmitters with channel bandwidth of up to 1 MHz	16
4.2.2.3.2 Transmitters other than those defined in clause 4.2.2.3.1	17
4.2.2.4 Limits.....	18
4.2.2.5 Conformance	18
4.2.3 Permitted range of operating frequencies	18
4.2.3.1 Applicability	18
4.2.3.2 Description	19
4.2.3.3 Method of measurement	19
4.2.3.4 Method of measurement for equipment using FHSS modulation.....	19
4.2.3.5 Limits.....	20
4.2.4 Unwanted emissions in the spurious domain	20
4.2.4.1 Applicability	20
4.2.4.2 Description	20
4.2.4.3 Method of measurement	20
4.2.4.3.0 General Requirements	20
4.2.4.3.1 Conducted spurious emission.....	21
4.2.4.3.2 Method of measurement - cabinet spurious radiation	21
4.2.4.3.3 Method of measurement - radiated spurious emission.....	22
4.2.4.3.4 Additional requirements for equipment employing FHSS modulation	23
4.2.4.4 Limits.....	23
4.2.4.5 Conformance	23
4.2.5 Duty cycle	23
4.2.5.1 Applicability	23
4.2.5.2 Description	23
4.2.5.3 Method of measurement	24
4.2.5.4 Limits.....	24
4.2.5.5 Conformance	25
4.2.6 Additional requirements for FHSS equipment	25
4.2.6.1 Applicability	25
4.2.6.2 Description	25

4.2.6.3	Method of measurement	25
4.2.6.4	Limits.....	25
4.2.6.5	Conformance	25
4.3	Receiver requirements	25
4.3.1	Receiver category.....	25
4.3.2	General performance criteria.....	26
4.3.3	Adjacent channel selectivity.....	26
4.3.3.1	Applicability	26
4.3.3.2	Description	26
4.3.3.3	Method of measurement	26
4.3.3.4	Limits.....	27
4.3.3.5	Conformance	27
4.3.4	Blocking or desensitization	27
4.3.4.1	Applicability	27
4.3.4.2	Description	27
4.3.4.3	Methods of measurement.....	27
4.3.4.4	Limits.....	28
4.3.4.5	Conformance	29
4.3.5	Spurious radiations	29
4.3.5.1	Applicability	29
4.3.5.2	Description	29
4.3.5.3	Method of measurement for spurious radiation	29
4.3.5.3.0	General Requirements.....	29
4.3.5.3.1	Method of measurement conducted spurious components.....	29
4.3.5.3.2	Method of measurement cabinet radiation.....	30
4.3.5.3.3	Method of measurement radiated spurious components	30
4.3.5.4	Limits.....	31
4.3.5.5	Conformance	31
4.4	Spectrum access techniques.....	31
4.4.1	Applicability.....	31
4.4.2	Listen Before Talk (LBT)	31
4.4.2.0	General	31
4.4.2.1	LBT timing parameters.....	32
4.4.2.1.1	Minimum transmitter off-time	32
4.4.2.1.2	LBT minimum listening time.....	32
4.4.2.1.3	Acknowledge transmissions.....	33
4.4.2.1.4	Maximum transmitter on-time	33
4.4.2.1.5	Declaration of LBT parameters.....	33
4.4.2.1.6	Manual and event driven devices.....	33
4.4.2.2	Receiver LBT threshold and transmitter max on-time.....	33
4.4.2.2.0	Applicability	33
4.4.2.2.1	Descriptions	34
4.4.2.2.2	Method of measurements.....	34
4.4.2.2.3	Limits	34
4.4.2.2.4	Conformance.....	35
4.4.3	Detect And Avoid techniques (DAA)	35
4.4.3.1	General requirements.....	35
4.4.4	Adaptive Frequency Agility (AFA)	35
4.4.4.1	General requirements.....	35
4.5	2,45 GHz RFID systems	36
4.6	GBSAR systems	36
4.6.1	Effective radiated power	36
4.6.2	Permitted range of operating frequencies.....	36
4.6.3	DAA threshold	36
4.6.3.0	General requirements.....	36
4.6.3.1	DAA timing parameters.....	36
4.6.3.1.1	Minimum listen time.....	36
4.6.3.1.2	Minimum listen time after detection.....	36
4.6.3.1.3	Maximum transmitter on-time	36
4.6.3.1.4	Minimum transmitter off-time	36
4.6.4	Antenna pattern	36

5	Testing for compliance with technical requirements.....	36
5.1	Environmental conditions for testing.....	36
5.2	Presentation of equipment for testing purposes	37
5.2.0	General	37
5.2.1	Choice of model for testing	37
5.2.2	Testing of equipment with alternative power levels.....	37
5.2.3	Testing of equipment that does not have an external 50 Ω RF connector (integral antenna equipment)	37
5.2.3.1	Equipment with an internal permanent or temporary antenna connector or using a dedicated test fixture	37
5.2.3.2	Equipment with a temporary antenna connector	38
5.2.4	Testing of devices using duty cycle	38
5.3	Mechanical and electrical design	38
5.3.1	General	38
5.3.2	Void.....	38
5.3.3	Transmitter shut-off facility	38
5.3.4	Receiver mute or squelch	38
5.4	Auxiliary test equipment.....	38
5.5	Test power source	39
5.5.0	General.....	39
5.5.1	External test power source	39
5.5.2	Internal test power source	39
5.6	Normal test conditions	39
5.6.1	Normal temperature and humidity	39
5.6.2	Normal test power source.....	39
5.6.2.1	Mains voltage	39
5.6.2.2	Battery power sources	40
5.6.2.3	Other power sources	40
5.7	Extreme test conditions.....	40
5.7.1	Extreme temperatures.....	40
5.7.1.1	Procedure for tests at extreme temperatures	40
5.7.1.1.0	General.....	40
5.7.1.1.1	Procedure for equipment designed for continuous operation.....	40
5.7.1.1.2	Procedure for equipment designed for intermittent operation.....	40
5.7.1.2	Extreme temperature ranges	41
5.7.2	Extreme test source voltages	41
5.7.2.1	Mains voltage	41
5.7.2.2	Battery power sources	41
5.7.2.3	Power sources using other types of batteries	41
5.7.2.4	Other power sources	41
5.8	General conditions	42
5.8.1	Normal test signals and test modulation.....	42
5.8.1.0	General	42
5.8.1.1	Normal test signals for data	42
5.8.2	Artificial antenna.....	42
5.8.3	Test fixture	43
5.8.3.0	General	43
5.8.3.1	Validation of the test-fixture in the temperature chamber	44
5.8.3.2	Mode of use	45
5.8.4	Test sites and general arrangements for radiated measurements	46
5.8.5	Measuring receiver.....	46
5.9	Interpretation of the measurement results	46
5.9.0	General	46
5.9.1	Measurement uncertainty is greater than maximum acceptable uncertainty	47
Annex A (informative):	Relationship between the present document and the essential requirements of Directive 2014/53/EU	48
Annex B (normative):	EU wide harmonised national radio interfaces from 1 GHz to 40 GHz ...	50
Annex C (informative):	National Radio Interfaces not EU wide harmonised	51

Annex D (informative):	Selection of technical parameters	53
D.1	Introduction	53
D.2	Receiver parameters	53
Annex E (normative):	Radiated measurements	54
E.1	General requirements for measurements involving the use of radiated fields	54
E.2	Test Sites	55
E.2.1	Outdoor test site	55
E.2.2	Indoor test site	56
E.2.3	Shielded anechoic test site	57
E.2.3.0	General	57
E.2.3.1	Influence of parasitic reflections in anechoic chambers	57
E.2.3.2	Calibration of the shielded RF anechoic chamber	57
E.3	Antennas	59
E.3.1	Test antenna	59
E.3.2	Substitution antenna	59
E.3.3	Artificial antenna	59
E.4	Test Practice and Auxiliary Test Equipment	60
E.5	Measuring distance	60
E.5.0	General	60
E.5.1	Standard position	60
E.5.2	Auxiliary cables	60
Annex F (normative):	General description of measurement methods	61
F.0	General	61
F.1	Conducted measurements	61
F.2	Radiated measurements	61
F.3	Radiated measurement for receivers	62
Annex G (normative):	Power limits for RFID systems operating in the 2,45 GHz band	63
G.1	Power limits and frequency band	63
G.1.0	General requirements	63
G.1.1	Additional requirements for 2,45 GHz 4 W e.i.r.p. indoor RFID equipment	63
G.1.2	Spectrum mask	64
Annex H (informative):	Example of implementation for restriction of 4 W RFID to in-building use only	65
Annex I (normative):	Limits for GBSAR operating in the frequency range 17,1 GHz to 17,3 GHz	67
I.1	Introduction	67
I.2	Effective radiated power (e.i.r.p.)	67
I.2.1	Definition	67
I.2.2	Method of measurement	67
I.2.3	Limits	67
I.3	Permitted range of operating frequencies	67
I.3.1	Definition	67
I.3.2	Method of measurement	67
I.3.3	Limits	68
I.4	Principles of Detection And Avoid (DAA)	68
I.4.0	General	68
I.4.1	DAA test set-up	68

I.4.2	Test signals	69
I.4.3	DAA threshold.....	69
I.4.3.1	Definition	69
I.4.3.2	Method of measurement.....	69
I.4.3.3	Limit.....	70
I.4.4	DAA timing parameters.....	70
I.4.4.1	Minimum listen Time.....	70
I.4.4.1.1	Definition.....	70
I.4.4.1.2	Method of measurement	70
I.4.4.1.3	Limit for minimum listen time	71
I.4.4.2	Minimum listen time after detection	71
I.4.4.2.1	Definition.....	71
I.4.4.2.2	Method of measurement	71
I.4.4.2.3	Limit	72
I.4.4.3	Maximum transmitter on-time.....	72
I.4.4.3.1	Definition.....	72
I.4.4.3.2	Method of measurement	72
I.4.4.3.3	Limit	73
I.4.4.4	Minimum transmitter off-time.....	73
I.4.4.4.1	Definition.....	73
I.4.4.4.2	Method of measurement	73
I.4.4.4.3	Limit	74
I.5	Antenna pattern	74
I.5.1	Definition.....	74
I.5.2	Method of measurements.....	74
I.5.3	Limits.....	76
Annex J (informative):	Bibliography.....	77
Annex K (informative):	Change History	78
History		79

Intellectual Property Rights

Essential patents

IPRs essential or potentially essential to normative deliverables may have been declared to ETSI. The information pertaining to these essential IPRs, if any, is publicly available for **ETSI members and non-members**, and can be found in ETSI SR 000 314: "*Intellectual Property Rights (IPRs); Essential, or potentially Essential, IPRs notified to ETSI in respect of ETSI standards*", which is available from the ETSI Secretariat. Latest updates are available on the ETSI Web server (<https://ipr.etsi.org/>).

Pursuant to the ETSI IPR Policy, no investigation, including IPR searches, has been carried out by ETSI. No guarantee can be given as to the existence of other IPRs not referenced in ETSI SR 000 314 (or the updates on the ETSI Web server) which are, or may be, or may become, essential to the present document.

Trademarks

The present document may include trademarks and/or tradenames which are asserted and/or registered by their owners. ETSI claims no ownership of these except for any which are indicated as being the property of ETSI, and conveys no right to use or reproduce any trademark and/or tradename. Mention of those trademarks in the present document does not constitute an endorsement by ETSI of products, services or organizations associated with those trademarks.

Foreword

This Harmonised European Standard (EN) has been produced by ETSI Technical Committee Electromagnetic compatibility and Radio spectrum Matters (ERM).

The present document has been prepared under the Commission's standardisation request C(2015) 5376 final [i.6] to provide one voluntary means of conforming to the essential requirements of Directive 2014/53/EU on the harmonisation of the laws of the Member States relating to the making available on the market of radio equipment and repealing Directive 1999/5/EC [i.1].

Once the present document is cited in the Official Journal of the European Union under that Directive, compliance with the normative clauses of the present document given in table A.1 confers, within the limits of the scope of the present document, a presumption of conformity with the corresponding essential requirements of that Directive and associated EFTA regulations.

National transposition dates	
Date of adoption of this EN:	16 July 2018
Date of latest announcement of this EN (doa):	31 October 2018
Date of latest publication of new National Standard or endorsement of this EN (dop/e):	30 April 2019
Date of withdrawal of any conflicting National Standard (dow):	30 April 2020

Modal verbs terminology

In the present document "**shall**", "**shall not**", "**should**", "**should not**", "**may**", "**need not**", "**will**", "**will not**", "**can**" and "**cannot**" are to be interpreted as described in clause 3.2 of the [ETSI Drafting Rules](#) (Verbal forms for the expression of provisions).

"**must**" and "**must not**" are **NOT** allowed in ETSI deliverables except when used in direct citation.

Introduction

The present document ~~defines technical~~ aims at providing requirements to support ~~demonstrate that the SRD devices to be used for the following equipment types can be presumed to conform to the essential requirements of clause/article 3.2 of the Radio Equipment Directive 2014/53/EU [i.1] which states "Radio equipment shall be so constructed that it both effectively uses and supports the efficient use of radio spectrum under the conditions identified in order to avoid harmful interference".~~ Annex A.

The present document ~~describes~~ aims to describe performance requirements and conformance test procedures for licence exempt Short Range Devices (SRDs) intending to use frequency bands within the range of 1 GHz to 40 GHz.

Equipment aiming to be covered by the present document may operate on a specific frequency or may be channel agile and operate on a number of different frequencies.

The present document is structured as follows:

- Clause 2 provides references.
- Clause 3 provides definitions of terms and abbreviations used.
- Clause 4 provides technical requirements specifications.
- Clause 5 provides conditions for testing for compliance with technical requirements.
- Annex A (informative): Relationship between the present document and the essential requirements of Directive 2014/53/EU.
- Annex B (normative): EU wide harmonised national radio interfaces from 1 GHz to 40 GHz.
- Annex C (informative): National Radio Interfaces not EU wide harmonised.
- Annex D (informative): Selection of technical parameters.
- Annex E (normative): Radiated measurements.
- Annex ~~E~~F (normative): General description of measurement methods.
- Annex ~~D~~G (normative): Power limits for RFID systems operating in the 2,45 GHz band.
- Annex ~~E~~H (informative): Example of implementation for restriction of 4 W RFID to in-building use only.
- Annex ~~F~~I (normative): Limits for GBSAR operating in the frequency range 17,1 GHz to 17,3 GHz.
- Annex ~~G~~J (informative): Bibliography.
- Annex ~~H~~K (informative): Change History.
- History.

1 Scope

The present document specifies technical characteristics and methods of measurements for the following equipment types:

- 1) Non specific Short Range Devices, including alarms, telecommand, telemetry, data transmission in general, etc.
- 2) Radio Frequency IDentification (RFID) devices.
- 3) Radiodetermination devices including detection, movement and alert applications.

These radio equipment types are capable of operating in the permitted frequency bands within the 1 GHz to 40 GHz range as specified in table 1:

- 1) with either a Radio Frequency (RF) output connection and dedicated antenna or an integral antenna;
- 2) for all types of modulation;
- 3) with or without speech.

Table 1 shows a list of the frequency bands as designated by the European Commission Decisions on Short Range Devices [i.5] and the CEPT/ERC Recommendation 70-03 [i.2] as known at the date of publication of the present document.

Table 1: Short Range Devices within the 1 GHz to 40 GHz permitted frequency bands

	Frequency Bands	Applications	Notes
Transmit and Receive	2 400 MHz to 2 483,5 MHz	Non-specific short range devices	
Transmit and Receive	2 400 MHz to 2 483,5 MHz	Radio determination Radiodetermination devices	
Transmit and Receive	(a) 2 446 MHz to 2 454 MHz	Radio Frequency Identification (RFID) devices	See annex D Annex G
Transmit and Receive	(b) 2 446 MHz to 2 454 MHz	Radio Frequency Identification (RFID) devices	See annex D Annex G
Transmit and Receive	5 725 MHz to 5 875 MHz	Non-specific short range devices	
Transmit and Receive	9 200 MHz to 9 500 MHz	Radio determination Radiodetermination devices	
Transmit and Receive	9 500 MHz to 9 975 MHz	Radio determination Radiodetermination devices	
Transmit and Receive	10,5 GHz to 10,6 GHz	Radio determination Radiodetermination devices	
Transmit and Receive	13,46 GHz to 14,0 GHz	Radio determination Radiodetermination devices	
Transmit and Receive	17,1 GHz to 17,3 GHz	Radio determination Radiodetermination devices	See annex F Annex I
Transmit and Receive	24,00 GHz to 24,25 GHz	Non-specific short range devices and Radio determination radiodetermination devices	
NOTE: (a) and (b) refer to two different operational restrictions for different power levels in the same frequency band.			

NOTE 1: ~~Table 1 represents the most widely implemented position within the European Union [i.5] and the CEPT countries [i.2], but it should not be assumed that not all designated frequency bands in table 1 are available implemented in all countries.~~ European countries. Annex B provides an overview of radio interfaces which are harmonised in the European Union. Annex C provides an overview of national radio interfaces not harmonised in the European Union. at date of publication.

NOTE 2: In addition, it should be noted that other frequency bands may be available in a country within the frequency range 1 GHz to 40 GHz covered by the present document. See the European Commission Decisions on Short Range Devices [i.5] and the CEPT ERC Recommendation 70-03 [i.2] as implemented through National Radio Interfaces (NRI) and additional NRI as relevant.

NOTE 3: On non-harmonised parameters, national administrations may impose certain conditions such as the type of modulation, frequency, channel/frequency separations, maximum transmitter radiated power, duty cycle, and the inclusion of an automatic transmitter shut-off facility, as a condition for the issue of an individual or general licence, or as a condition for the issuing of Individual Rights for use of spectrum or General Authorization, or as a condition for use "under licence exemption" as it is in most cases for Short Range Devices.

The present document covers fixed stations, mobile stations and portable stations.

Applications using Ultra Wide Band (UWB) technology are not covered by the present document.

~~NOTE 4: The relationship between the present document covers the and essential requirements of article 3.2 of Directive 2014/53/EU [i.6] under the conditions identified is given in annex Annex A.~~

2 References

2.1 Normative references

References are specific, identified by date of publication and/or edition number or version number. Only the cited version applies.

Referenced documents which are not found to be publicly available in the expected location might be found at <https://docbox.etsi.org/Reference/>.

NOTE: While any hyperlinks included in this clause were valid at the time of publication, ETSI cannot guarantee their long term validity.

The following referenced documents are necessary for the application of the present document.

- [1] CISPR 16-1-1 (2015): "Specification for radio disturbance and immunity measuring apparatus and methods; Part 1-1: Radio disturbance and immunity measuring apparatus - Measuring apparatus".
- [2] CISPR 16-1-4 (2010): "Specification for radio disturbance and immunity measuring apparatus and methods; Part 1-4: Radio disturbance and immunity measuring apparatus - Antennas and test sites for radiated disturbance measurements".
- [3] CISPR 16-1-5 (2015/2014): "Specification for radio disturbance and immunity measuring apparatus and methods; Part 1-5: Radio disturbance and immunity measuring apparatus - Antenna calibration sites and reference test sites for 5 MHz to 18 GHz".
- [4] Recommendation ITU-T O.41 (1994): "Psophometer for use on telephone-type circuits".
- [5] Recommendation ITU-T O.153 (1992): "Basic parameters for the measurement of error performance at bit rates below the primary rate".
- [6] Commission Implementing Decision (EU) 2017/1483 of 8 August 2017 amending Decision 2006/771/EC on harmonisation of the radio spectrum for use by short-range devices and repealing Decision 2006/804/EC.

2.2 Informative references

References are either specific (identified by date of publication and/or edition number or version number) or non-specific. For specific references, only the cited version applies. For non-specific references, the latest version of the referenced document (including any amendments) applies.

NOTE: While any hyperlinks included in this clause were valid at the time of publication, ETSI cannot guarantee their long term validity.

The following referenced documents are not necessary for the application of the present document but they assist the user with regard to a particular subject area.

- [i.1] Directive 2014/53/EU of the European Parliament and of the Council of 16 April 2014 on the harmonisation of the laws of the Member States relating to the making available on the market of radio equipment and repealing Directive 1999/5/EC (RE-Directive).
- [i.2] CEPT/ERC Recommendation 70-03: "Relating to the use of Short Range Devices (SRD)".
- [i.3] Recommendation ITU-R SM.1755: "Characteristics of ultra-wideband technology".
- [i.4] ETSI TR 100 028 (V1.4.1) (all parts): "Electromagnetic compatibility and Radio spectrum Matters (ERM); Uncertainties in the measurement of mobile radio equipment characteristics".
- [i.5] Commission Decision 2013/752/EC on harmonization of the radio spectrum for use by short-range devices as amended by subsequent Commission Decisions.
- [i.6] Commission Implementing Decision C(2015) 5376 final of 4.8.2015 on a standardisation request to the European Committee for Electrotechnical Standardisation and to the European Telecommunications Standards Institute as regards radio equipment in support of Directive 2014/53/EU of the European Parliament and of the Council.
- [i.7] Recommendation ITU-R SM.329-12 (2012): "Unwanted emissions in the spurious domain".
- [i.8] CEPT/ERC/Recommendation 74-01E: "Unwanted emissions in the spurious domain".
- [i.9] R&TTE Subclasses of Class1 Equipment December 2014: Publication in accordance with Article 1(3) of Commission Decision 2000/299/EC (Version December 2014).
- [i.10] ETSI EG 203 336 (V1.1.1): "Electromagnetic compatibility and Radio spectrum Matters (ERM); Guide for the selection of technical parameters for the production of Harmonised Standards covering article 3.1(b) and article 3.2 of Directive 2014/53/EU".

3 Definitions, symbols and abbreviations

3.1 Definitions

For the purposes of the present document, the following terms and definitions apply:

adjacent channels: two channels offset from the nominal channel by the nominal channel bandwidth

alarm: use of radio communication for indicating an alarm condition at a distant location

alternate adjacent channels: two channels offset from the nominal channel by double the channel bandwidth

NOTE 1: ~~The operating channel width is described by the occupied bandwidth (see definition below) of the wanted emissions; i.e. the width of a frequency band such that, below the lower and above the upper frequency limits, the mean powers emitted are each equal to a specified percentage 0,5 % of the total mean power of a given emission. In addition, the occupied bandwidth of the emissions as defined by the ITU-R radio regulations is not to exceed the operating channel width.~~

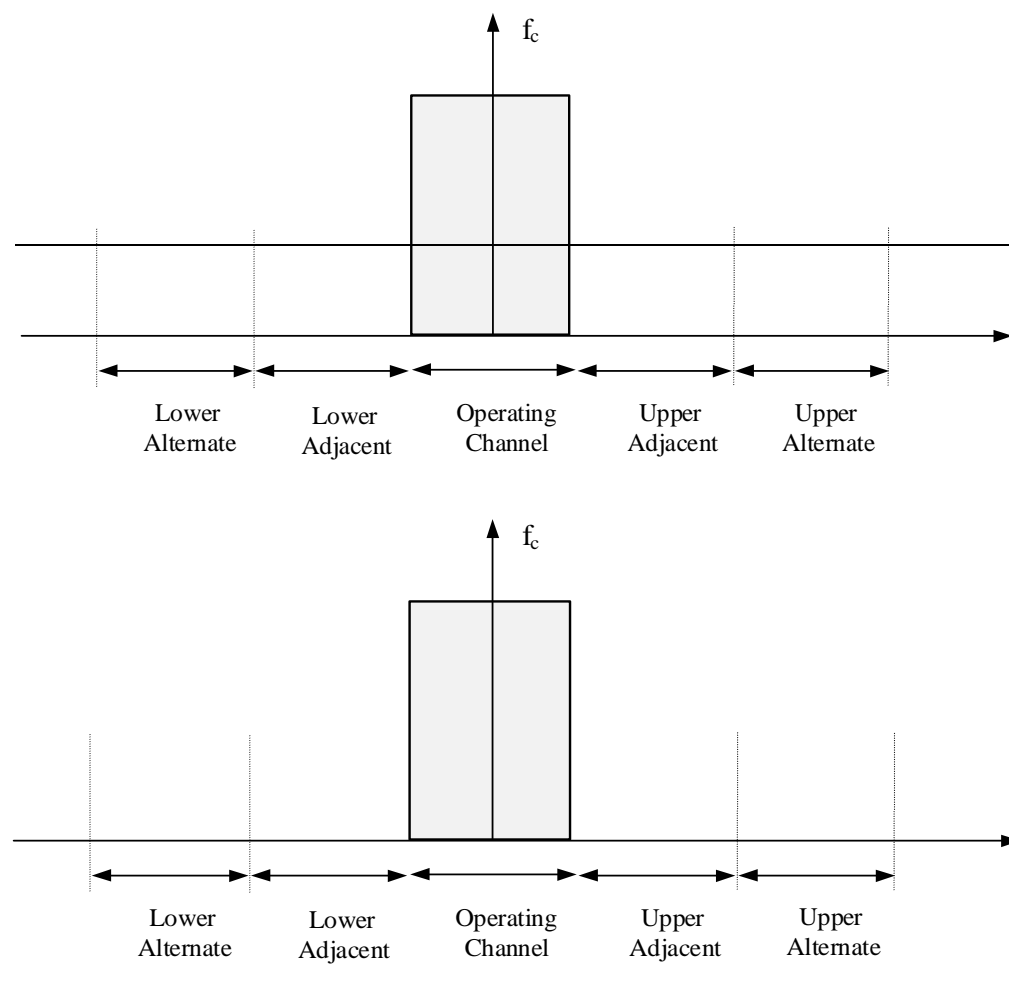

Figure 1: Adjacent and alternate adjacent channel definitions

NOTE-2: For equipment to be used in a frequency band where channelization is not defined by regulation, the channel spacing of the equipment is defined by the manufacturer.

artificial antenna: non-radiating dummy load equal to the nominal impedance specified by the manufacturer

assigned frequency band: frequency band within which the device is authorized to operate and to perform the intended function of the equipment

chip: unit of modulation used in Direct Sequence Spread Spectrum (DSSS) modulation

chip rate: number of chips per second in DSSS

conducted measurements: measurements which are made using a direct connection to the equipment under test

cumulative on-time (T_{on_cum}): sum of T_{on} , within T_{obs}

dedicated antenna: removable antenna supplied and tested with the radio equipment, designed as an indispensable part of the equipment

Direct Sequence Spread Spectrum (DSSS): form of modulation where a combination of data to be transmitted and a fixed-code sequence (chip sequence) is used to directly modulate a carrier, e.g. by phase shift keying

NOTE: The ~~code~~chip rate determines the occupied bandwidth.

Duty Cycle (DC): ratio expressed as a percentage, of the cumulative duration of transmissions T_{on_cum} within an observation interval T_{obs} . $DC = \left(\frac{T_{on_cum}}{T_{obs}} \right)_{F_{obs}}$ on an observation bandwidth F_{obs}

equivalent isotropically radiated power: maximum radiated power of the transmitter and its antenna

fixed station: equipment intended for use in a fixed location

Frequency Hopping Spread Spectrum (FHSS): spread spectrum technique in which the transmitter signal occupies a number of frequencies in time, each for some period of time, referred to as the dwell time

NOTE: Transmitter and receiver follow the same frequency hop pattern. The number of hop positions and the bandwidth per hop position determine the occupied bandwidth.

identification system: equipment consisting of a transmitter(s), receiver(s) (or a combination of the two) and an antenna(s) to identify objects by means of a transponder

integral antenna: permanent fixed antenna, which may be built-in, designed as an indispensable part of the equipment

mobile station: equipment normally fixed in a vehicle or used as a transportable station

observation bandwidth (F_{obs}): bandwidth in which the energy of an equipment is considered for the purposes of assessing transmission timings

observation period (T_{obs}): reference interval of time

occupied bandwidth: width of a frequency band such that, below the lower and above the upper frequency limits the mean powers emitted are each equal to 0,5 % of the total mean power of a given emission

~~NOTE: The mean powers emitted are each equal to 0,5 % of the total mean power of a given emission.~~

off-time (T_{off}): time duration between two successive transmissions

on-time (T_{on}): duration on a Transmission Operating Channel (OC)

~~NOTE: Frequency~~ **Operating Channel (OC):** frequency range in which the ~~Transmission~~ transmission from the equipment occurs; defined by two frequency edges values. ~~Declared by manufacturer: F_{low} and F_{high}~~

Operating Channel Width (OCW): bandwidth between the two frequencies ~~declared as operating~~ F_{low} and F_{high} channel

operating frequency: nominal frequency at which equipment is operated; this is also referred to as the operating centre frequency

NOTE: Equipment may be able to operate at more than one operating frequency.

operating frequency range: range of operating frequencies over which the equipment can be adjusted through tuning, switching or reprogramming

out-of-band emissions: emission on a frequency or frequencies ~~immediately~~ outside the occupied bandwidth which results from the modulation process, but excluding spurious emissions

portable station: equipment intended to be carried, attached or implanted

radiated measurements: measurements which involve the absolute measurement of a radiated field

~~radio determination~~ **radiodetermination:** determination of the position, velocity and/or other characteristics of an object, or the obtaining of information relating to these parameters, by means of the propagation properties of radio waves

spread spectrum: modulation technique in which the energy of a transmitted signal is spread throughout a large portion of the frequency spectrum

spurious emissions: emission on a frequency or frequencies which are outside the occupied bandwidth and the level of which may be reduced without affecting the corresponding transmission of information

NOTE: Spurious emissions include harmonic emissions, parasitic emissions, intermodulation products and frequency conversion products, but exclude out-of-band emissions.

telecommand: use of radio communication for the transmission of signals to initiate, modify or terminate functions of equipment at a distance

telemetry: use of radio communication for indicating or recording data at a distance

transponder: device which responds to an interrogation signal

Ultra Wide Band (UWB) technology: technology for short-range radiocommunication, involving the intentional generation and transmission of radio-frequency energy that spreads over a very large frequency range, which may overlap several frequency bands allocated to radiocommunication services as defined in Recommendation ITU-R-SM.1755 [i.3]

3.2 Symbols

For the purposes of the present document, the following symbols apply:

D_{ant}	Aperture dimension of the radiating antenna
E	Electrical field strength
E_0	Reference electrical field strength, (see annex B)
f	Frequency
P	Power
R	Distance
R_0	Reference distance, (see annex B)
t	Time
λ	wavelength

3.3 Abbreviations

For the purposes of the present document, the following abbreviations apply:

ACS	Adjacent Channel Selectivity
ac	alternating current
AFA	Adaptive Frequency Agility
CW	Continuous Wave (transmission)
DAA	Detect And Avoid spectrum access technique
dB	decibel
dB _i	gain in decibels relative to an isotropic antenna
dBm	decibel-milliwatts
dc	direct current
DC	Duty Cycle
DSSS	Direct Sequence Spread Spectrum
e.i.r.p.	equivalent isotropically radiated power
EMC	ElectroMagnetic Compatibility
ERC	European Radiocommunication Committee
EUT	Equipment Under Test
FAR	Fully Anechoic Room
FHSS	Frequency Hopping Spread Spectrum
GBSAR	Ground Based Synthetic Aperture Radar
ITU-R	International Telecommunications Union, Radio Sector <u>sector</u>
ITU-T	International Telecommunications Union, Telecommunications Sector <u>sector</u>
LBT	Listen Before Talk
NRI	National Radio Interfaces
OC	Operating Channel
OCW	Operating Channel Width
R&TTE	Radio and Telecommunications Terminal Equipment
OFDM	Orthogonal Frequency Division Modulation
PRR	Pulse Repetition Rate
RBW	Reference BandWidth
RF	Radio Frequency
RFID	Radio Frequency IDentification
RMS	Root Mean Square
SCU	System Control Unit
SF-CW	Step Frequency Continuous Wave (spread spectrum)
SND/ND	Signal + Noise + Distortion divided by Noise + Distortion
SRD	Short Range Device

Tx	Transmitter
UWB	Ultra Wide Band
VSWR	Voltage Standing Wave Ratio

4 Technical requirements specifications

4.1 Environmental profile

The technical requirements of the present document apply under the environmental profile for operation of the equipment, which shall be declared by the manufacturer. The equipment shall comply with all the technical requirements of the present document which are identified as applicable in Annex A at all times when operating within the boundary limits of the declared operational environmental profile.

4.2 Transmitter requirements

4.2.1 Transmitter measurement requirements

4.2.1.1 Applicability

The general requirements in clause 4.2.1.2 shall apply to all EUT when in transmit mode.

4.2.1.2 Methods of measurement and limits for transmitter parameters

Where the transmitter is designed with adjustable carrier power, then all transmitter parameters shall be measured using the highest power level, ~~as declared by the manufacturer.~~ The equipment shall then be set to the lowest carrier power setting, ~~as declared by the manufacturer,~~ and the measurements for spurious emissions shall be repeated (see clause 4.2.4).

If the equipment to be tested is designed with a permanent external 50 Ω RF connector and a dedicated or integral antenna, then full tests shall be carried out using this connector. If the RF connector is not 50 Ω , then a calibrated coupler or attenuator shall be used to provide the correct termination impedance to facilitate the measurements. The equivalent isotropically radiated power is then calculated from the declared antenna gain.

If a system includes transponders, these are measured together with the interrogator.

In addition, the following tests shall be carried out with the dedicated or integrated antenna:

- equivalent isotropically radiated power (see clause 4.2.2);
- spurious emissions (see clause 4.2.3).

~~The equipment shall fulfil the requirements of the stated measurements.~~

4.2.2 Equivalent isotropically radiated power (e.i.r.p.)

4.2.2.1 Applicability

The equivalent isotropically radiated power requirement shall apply to all transmitters.

4.2.2.2 Description

The e.i.r.p. is defined as the maximum radiated power of the transmitter and its antenna, and is measured and calculated according to the procedure given in the following clause. See clause 5 for the test conditions.

4.2.2.3 Method of measurement

4.2.2.3.0 General requirements

To measure e.i.r.p. it is first necessary to determine the appropriate method of measurement: see clauses 4.2.2.3.1 and 4.2.2.3.2. The -6 dB transmitter bandwidth shall be determined using a 100 kHz measuring bandwidth in order to establish which measurement method is applicable:

- clause 4.2.2.3.1 for Non spread spectrum transmitters with a -6 dB bandwidth of up to 20 MHz and spread spectrum transmitters with channel bandwidth of up to 1 MHz;
- clause 4.2.2.3.2 for all other transmitter bandwidths.

Using the applicable measurement procedure as described in the present clause 4.2.2.3.2 and ~~annex B~~ Annex E, the power output shall be measured and recorded in the test report. The method of measurement shall be documented in the test report.

Measurements shall be performed at normal test conditions (see clause 5.6).

Where possible, the equipment shall be able to operate in a continuous transmit mode for testing purposes.

4.2.2.3.1 Non spread spectrum transmitters with a -6 dB bandwidth of up to 20 MHz and spread spectrum transmitters with channel bandwidth of up to 1 MHz

4.2.2.3.1.0 General

The method of measurement in clauses 4.2.2.3.1.1 or 4.2.2.3.1.2 shall only be used for:

- non spread spectrum equipment with a -6 dB bandwidth of 20 MHz or less and a duty cycle above 50 %;
- spread spectrum equipment with a -6 dB channel bandwidth of 1 MHz or less.

For peak power measurements, a spectrum analyser or frequency-selective voltmeter shall be used and tuned to the transmitter carrier at which the highest level is detected.

For FHSS systems, the hop frequency which provides the maximum indicated level shall be used. The frequency shall be indicated in the test report.

Other transmitters are tested according to clause 4.2.2.3.2.

4.2.2.3.1.1 Equipment measured as constant envelope modulation equipment

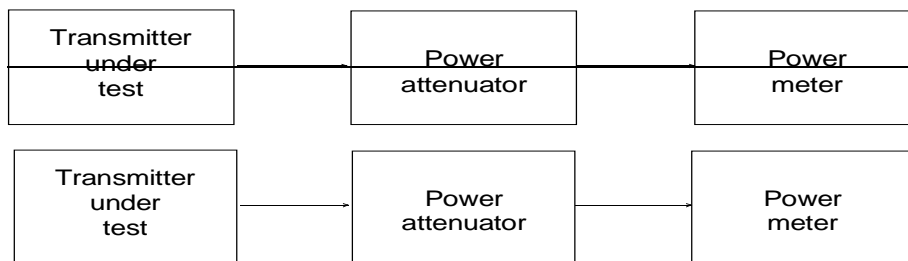

Figure 2: Measurement arrangement

For practical reasons, measurements shall be performed only at the highest power level at which the transmitter is intended to operate. The measurement arrangement in figure 2 shall be used.

The measurement shall be performed preferably in the absence of modulation.

When it is not possible to measure it in the absence of modulation, this fact shall be stated in test reports.

The transmitter shall be set in continuous transmission mode. If this is not possible, the measurements shall be carried out in a period shorter than the duration of the transmitted burst. It may be necessary to extend the duration of the burst.

The transmitter shall be connected to an artificial antenna (see clause 5.8.2) and the power delivered to this artificial antenna shall be measured.

The equivalent isotropically radiated power is then calculated from the measured value, the known antenna gain, relative to an isotropic antenna, and if applicable, any losses due to cables and connectors in the measurement system.

4.2.2.3.1.2 Equipment measured as non-constant envelope modulation equipment

The measurement shall be performed with test signals D-M2 or D-M3 as appropriate.

The transmitter shall be preferably set in continuous transmission mode. If this is not possible, the measurement can be performed in discontinuous mode.

The transmitter shall be connected to an artificial antenna (see clause 5.8.2) and the power delivered to this artificial antenna shall be measured. The measuring instrument shall have a measurement bandwidth not less than sixteen times the channel bandwidth.

The equivalent isotropically radiated power is then calculated from the measured value, the known antenna gain, relative to an isotropic antenna, and if applicable, any losses due to cables and connectors in the measurement system.

4.2.2.3.2 Transmitters other than those defined in clause 4.2.2.3.1

This method of measurement shall be used for:

- a) equipment with a -6 dB bandwidth greater than 20 MHz, and equipment with a duty cycle below 50 %; or for
- b) spread spectrum equipment with a channel bandwidth above 1 MHz.

The equivalent isotropically radiated power shall be determined and recorded.

In case of radiated measurements on smart antenna systems using symmetrical power distribution across the available transmit chains, the EUT should, where possible, be configured so that only one transmit chain (antenna) is activated while the other transmit chains are disabled. Where this is not possible, the method used shall be documented in the test report. If only one transmit chain was tested, the result for the active transmit chain shall be corrected to be valid for the whole system (all transmit chains).

NOTE: The power (in mW) for one transmit chain needs to be multiplied with the number of transmit chains to obtain the total power for the system.

The measurement shall be performed using normal operation of the equipment with the test modulation applied (see clause 5.8.1).

The test procedure shall be as follows:

Step 1:

- using a suitable means, the output of the transmitter shall be coupled to a matched diode detector;
- the output of the diode detector shall be connected to the vertical channel of an oscilloscope;
- the combination of the diode detector and the oscilloscope shall be capable of faithfully reproducing the envelope peaks and the duty cycle of the transmitter output signal;
- the observed duty cycle of the transmitter ($T_x \text{ on} / (T_x \text{ on} + T_x \text{ off})$) shall be noted as x , ($0 < x < 1$) and recorded.

Step 2:

- the average output power of the transmitter shall be determined using a wideband, calibrated RF power meter with a matched thermocouple detector or an equivalent thereof and, where applicable, with an integration period that exceeds the repetition period of the transmitter by a factor 5 or more. The observed value shall be recorded as "A" (in dBm);
- the e.i.r.p. shall be calculated from the above measured power output A, the observed duty cycle x , and the applicable antenna assembly gain "G" in dBi, according to the formula:
 - $P = A + G + 10 \log (1/x)$;
 - P shall not exceed the value specified in clause 4.2.2.4.

The measurement shall be repeated at the lowest, the middle, and the highest frequency of the stated frequency range. These frequencies shall be recorded. FHSS equipment shall be made to hop continuously to each of these three frequencies separately.

4.2.2.4 Limits

The transmitter maximum e.i.r.p. under normal and extreme test conditions is provided in table 2.

Table 2: Maximum radiated peak-power (e.i.r.p.)

Entry	Frequency Bands	Power	Application	Notes
1	2 400 MHz to 2 483,5 MHz	10 mW e.i.r.p.	Non-specific short range devices	
2	2 400 MHz to 2 483,5 MHz	25 mW e.i.r.p.	Radio determination Radiodetermination devices	
3	(a) 2 446 MHz to 2 454 MHz	500 mW e.i.r.p.	Radio Frequency Identification (RFID) devices	See also table 4 and annex D Annex G
4	(b) 2 446 MHz to 2 454 MHz	4 W e.i.r.p.	Radio Frequency Identification (RFID) devices	See also table 4 and annex D Annex G
5	5 725 MHz to 5 875 MHz	25 mW e.i.r.p.	Non-specific short range devices	
6	9 200 MHz to 9 500 MHz	25 mW e.i.r.p.	Radio determination Radiodetermination devices	
7	9 500 MHz to 9 975 MHz	25 mW e.i.r.p.	Radio determination Radiodetermination devices	
8	10,5 GHz to 10,6 GHz	500 mW e.i.r.p.	Radio determination Radiodetermination devices	
9	13,4 GHz to 14,0 GHz	25 mW e.i.r.p.	Radio determination Radiodetermination devices	
10	17,1 GHz to 17,3 GHz	400 mW e.i.r.p.	Radio determination Radiodetermination devices	See annex F Annex H
11	24,00 GHz to 24,25 GHz	100 mW e.i.r.p.	Non-specific short range devices and Radio determination radiodetermination devices	
NOTE: The spectrum ranges in some entries are not harmonised throughout all EU territory, specifically entries 4, 9, and 11 have been identified as such. Implementers are cautioned to refer to CEPT/ERC Recommendation 70-03 [j.2] as well as current National Radio plans to verify acceptance within intended regions of use.				

4.2.2.5 Conformance

The transmitter maximum e.i.r.p. measurements shall be performed as described in clause 4.2.2.3 and not exceed the limits in clause 4.2.2.4. The values and measurement method utilized shall be stated in the test report.

4.2.3 Permitted range of operating frequencies

4.2.3.1 Applicability

The Permitted range of operating frequencies shall apply to all transmitters.

4.2.3.2 Description

The permitted range of operating frequencies includes all frequencies on which the equipment may operate within an assigned frequency band. The operating frequency range shall be declared by the manufacturer.

The frequency range of the equipment is determined by the lowest and highest frequencies occupied by the power envelope in accordance with clause 4.2.2.4, table 2.

FH is the highest frequency of the power envelope, it is the frequency furthest above the frequency of maximum power where the output power envelope drops below the level of -75 dBm/Hz spectral power density (e.g. -30 dBm if measured in a 30 kHz reference bandwidth) e.i.r.p.

FL is the lowest frequency of the power envelope; it is the frequency furthest below the frequency of maximum power where the output power drops below the level of -75 dBm/Hz spectral power density (e.g. -30 dBm if measured in a 30 kHz reference bandwidth) e.i.r.p.

~~The occupied bandwidths and OCW of the transmitter shall be declared.~~ Where differing modes of emission are available, all modes and their associated bandwidths shall be stated.

~~The range of frequencies, determined by clause 4.2.3, shall be specified in the test report.~~

4.2.3.3 Method of measurement

The method of measurement for equipment employing FHSS and stepped frequency modulation is given in clause 4.2.3.4.

Using applicable conducted measurement procedures, as described in ~~annex C~~ Annex E, the frequency range(s) shall be measured and recorded in the test report.

Where applicable, during these measurements the test data sequence as specified in clauses 5.8.1 and 5.8.1.1 shall be used. The transmitter power level shall be set to the rated power level. During the test, the transmitter shall be set in continuous transmission mode. If this is not possible, the measurements shall be carried out in a period shorter than the duration of the transmitted burst. It may be necessary to extend the duration of the burst.

These measurements shall be performed under both normal and extreme operating conditions except for the occupied bandwidth assessment for which measurement at normal operating conditions is sufficient.

The measurement procedure shall be as follows:

- a) put the spectrum analyser in video averaging mode with a minimum of 50 sweeps selected;
- b) select the lowest operating frequency of the equipment under test and activate the transmitter with modulation applied. The RF emission of the equipment shall be displayed on the spectrum analyser;
- c) using the marker of the spectrum analyser, find the lowest frequency below the operating frequency at which the spectral power density drops below the level given in clause 4.2.3.2. This frequency shall be recorded in the test report;
- d) select the highest operating frequency of the equipment under test and find the highest frequency at which the spectral power density drops below the value given in clause 4.2.3.2. This frequency shall be recorded in the test report;
- e) the difference between the frequencies measured in steps c) and d) is the operating frequency range. It shall be recorded in the test report.

This measurement shall be repeated for each frequency range declared by the manufacturer.

4.2.3.4 Method of measurement for equipment using FHSS modulation

Using an applicable conducted measurement procedure as described in ~~annex B~~ Annex E the frequency range of the equipment shall be measured and recorded in the test report.

During these measurements the test data sequence, as specified in clause 5.8.1, shall be used. During the test, the transmitter shall be set in continuous transmission mode. If this is not possible, the measurements shall be carried out in a period shorter than the duration of the transmitted burst. It may be necessary to extend the duration of the burst.

The transmitter power level shall be set to the maximum power level if controllable.

These measurements shall be performed under both normal and extreme operating conditions.

The measurement procedure shall be as follows:

- a) put the spectrum analyser in video averaging mode with a minimum of 50 sweeps selected;

- b) select the lowest hop frequency of the equipment under test and activate the transmitter with modulation applied;
- c) find the lowest frequency below the operating frequency at which the spectral power density drops below the level given in clause 4.2.3.2. This frequency shall be recorded in the test report;
- d) select the highest hop frequency of the equipment under test and find the highest frequency at which the spectral power density drops below the level given in clause 4.2.3.2. This frequency shall be recorded in the test report;
- e) the difference between the frequencies measured in steps c) and d) is the frequency range. It shall be recorded in the test report.

This measurement shall be repeated for each operating frequency range declared by the manufacturer.

4.2.3.5 Limits

The width of the power spectrum envelope is $f_H - f_L$ for a given operating frequency. In equipment that allows adjustment or selection of different operating frequencies, the power envelope takes up different positions in the allowed band. The frequency range is determined by the lowest value of f_L and the highest value of f_H resulting from the adjustment of the equipment to the lowest and highest operating frequencies.

The occupied bandwidth (i.e. the bandwidth in which 99 % of the wanted emission is contained) of the transmitter shall fall within the assigned frequency band.

For all equipment the frequency range shall lie within the frequency band given by clause 4.2.2.4, table 2. For non-harmonized frequency bands the available frequency range may differ between national administrations.

4.2.4 Unwanted emissions in the spurious domain

4.2.4.1 Applicability

The unwanted emissions in the spurious domain requirement shall apply to all transmitters.

4.2.4.2 Description

According to CEPT/ERC/Recommendation 74-01E [i.8], and Recommendation ITU-R SM.329-12 [i.7], the boundary between the out-of-band and spurious domains is $\pm 250\%$ of the ~~necessary~~ occupied bandwidth from the centre frequency of the emission. Out-of-band and spurious emissions are measured as spectral power density under normal operating conditions.

Unwanted emissions in the spurious domain (spurious emissions) are those at frequencies beyond the limit of 250 % of the occupied bandwidth above and below the centre frequency of the emission. The occupied bandwidth is ~~either~~ measured ~~or as~~ declared by the manufacturer.

4.2.4.3 Method of measurement

4.2.4.3.0 General Requirements

The level of spurious emissions shall be measured as either:

- ~~a)~~
 - ~~i)~~—their power level in a specified load (conducted emission); and
 - a) ~~ii)~~—their effective radiated power when radiated by the cabinet and structure of the equipment (cabinet radiation); or
- b) ~~b)~~—their effective radiated power when radiated by the cabinet and the integral or dedicated antenna, in the case of equipment fitted with such an antenna and no permanent RF connector.

For measurements above 1 000 MHz the peak value shall be measured using a spectrum analyser. The "max hold" function of a spectrum analyser shall be used. For measurements up to 1 000 MHz the quasi-peak detector set in accordance with the specification of CISPR 16 [1], [2] and [3] shall be used.

The correction for RBW described in clause 5.8.5 is to be applied to the measured results as applicable.

4.2.4.3.1 Conducted spurious emission

This method of measurement applies to transmitters having a permanent antenna connector.

Additional requirements for equipment employing FHSS modulation are given in clause 4.2.4.3.4:

- a) The transmitter shall be connected to a measuring receiver through a test load, 50 Ω power attenuator, and if necessary, an appropriate filter to avoid overload of the measuring receiver. The bandwidth of the measuring receiver shall be adjusted until the sensitivity of the measuring receiver is at least 6 dB below the spurious emission limit given in table 3, see clause 4.2.4.4. This bandwidth shall be recorded in the test report.

For the measurement of spurious emissions below the second harmonic of the carrier frequency, the filter used shall be a high "Q" (notch) filter centred on the transmitter carrier frequency, which attenuates this signal by at least 30 dB.

For the measurement of spurious emissions at and above the second harmonic of the carrier frequency the filter used shall be a high pass filter with a stop band rejection exceeding 40 dB. The cut-off frequency of the high pass filter shall be approximately 1,5 times the transmitter carrier frequency.

Precautions may be required to ensure that the test load does not generate or that the high pass filter does not attenuate, the harmonics of the carrier.

- b) The transmitter shall be unmodulated and operating at the maximum limit of its specified power range. If modulation cannot be inhibited then the test shall be carried out with modulation (see clause 5.8.1) and this fact shall be recorded in the test report.
- c) For carrier frequencies in the range 1 GHz to 20 GHz the frequency of the measuring receiver shall be adjusted over the frequency range 25 MHz to 10 times the carrier frequency, not exceeding 40 GHz. For carrier frequencies above 20 GHz the measuring receiver shall be tuned over the range 25 MHz up to twice the carrier frequency, not exceeding 66 GHz. The frequency and level of every spurious emission found shall be noted. The emissions within the channel occupied by the transmitter carrier and, for channelized systems its adjacent channels, shall not be recorded.
- d) If the measuring receiver has not been calibrated in terms of power level at the transmitter output, the level of any detected components shall be determined by replacing the transmitter by the signal generator and adjusting it to reproduce the frequency and level of every spurious emission noted in step c). The absolute power level of each of the emissions shall be noted.
- e) The frequency and level of each spurious emission measured and the bandwidth of the measuring receiver shall be recorded in the test report.
- f) If a user accessible power adjustment is provided then the tests in steps c) to e) shall be repeated at the lowest power setting available.
- g) The measurement in steps c) to f) shall be repeated with the transmitter in the standby condition if this option is available.

4.2.4.3.2 Method of measurement - cabinet spurious radiation

This method of measurement applies to transmitters having a permanent antenna connector. For equipment without a permanent antenna connector see clause 4.2.4.3.3.

Additional requirements for equipment employing FHSS modulation are given in clause 4.2.4.3.4:

- a) A test site selected from ~~annex B~~ Annex E which fulfils the requirements of the specified frequency range of this measurement shall be used. The test antenna shall be oriented initially for vertical polarization and connected to a measuring receiver. The bandwidth of the measuring receiver shall be adjusted until the sensitivity of the measuring receiver, after allowing for the coupling loss, is at least 6 dB below the spurious emission limit given in table 3, see clause 4.2.4.4. This bandwidth shall be recorded in the test report.

The transmitter under test shall be placed on the support in its standard position, connected to an artificial antenna (see clause 5.8.2) and switched on without modulation. If modulation cannot be inhibited then the test shall be carried out with modulation, (see clause 5.8.1), and this fact shall be recorded in the test report.

- b) For carrier frequencies in the range 1 GHz to 20 GHz the frequency of the measuring receiver shall be adjusted over the frequency range 25 MHz to 10 times the carrier frequency, not exceeding 40 GHz. For carrier frequencies above 20 GHz the measuring receiver shall be tuned over the range 25 MHz up to twice the carrier frequency, not exceeding 66 GHz, except for the channel on which the transmitter is intended to operate and for channelized systems, its adjacent channels. The frequency of each spurious emission detected shall be noted. If the test site is disturbed by interference coming from outside the site, this qualitative search may be performed in a screened room, with a reduced distance between the transmitter and the test antenna.
- c) At each frequency at which an emission has been detected, the measuring receiver shall be tuned and the test antenna shall be raised or lowered through the specified height range until the maximum signal level is detected on the measuring receiver.
- d) The transmitter shall be rotated through 360° about a vertical axis, to maximize the received signal.
- e) The test antenna shall be raised or lowered again through the specified height range until a maximum is obtained. This level shall be noted.
- f) The substitution antenna (see clause E.3.2) shall replace the transmitter antenna in the same position and in vertical polarization. It shall be connected to the signal generator.
- g) At each frequency at which an emission has been detected, the signal generator, substitution antenna, and measuring receiver shall be tuned. The test antenna shall be raised or lowered through the specified height range until the maximum signal level is detected on the measuring receiver. The level of the signal generator giving the same signal level on the measuring receiver as in item e) shall be noted. After corrections due to the gain of the substitution antenna and the cable loss between the signal generator and the substitution antenna, is the radiated spurious emission at this frequency.
- h) The frequency and level of each spurious emission measured and the bandwidth of the measuring receiver shall be recorded in the test report.
- i) Steps c) to h) shall be repeated with the test antenna oriented in horizontal polarization.
- j) If a user accessible power adjustment is provided then the tests in steps c) to h) shall be repeated at the lowest power setting available.
- k) Steps c) to i) shall be repeated with the transmitter in the standby condition if this option is available.

4.2.4.3.3 Method of measurement - radiated spurious emission

This method of measurement applies to transmitters having an integral antenna.

Additional requirements for equipment employing FHSS modulation are given in clause 4.2.4.3.4:

- a) A test site selected from ~~annex B~~ Annex E which fulfils the requirements of the specified frequency range of this measurement shall be used. The test antenna shall be oriented initially for vertical polarization and connected to a measuring receiver, through a suitable filter to avoid overloading of the measuring receiver if required. The bandwidth of the measuring receiver shall be adjusted until the sensitivity of the measuring receiver, after allowing for the coupling loss, is at least 6 dB below the spurious emission limit given in table 3, see clause 4.2.4.4. This bandwidth shall be recorded in the test report.

For the measurement of spurious emissions below the second harmonic of the carrier frequency the optional filter used shall be a high "Q" (notch) filter centred on the transmitter carrier frequency and attenuating this signal by at least 30 dB.

For the measurement of spurious emissions at and above the second harmonic of the carrier frequency the optional filter used shall be a high pass filter with a stop band rejection exceeding 40 dB. The cut-off frequency of the high pass filter shall be approximately 1,5 times the transmitter carrier frequency.

The transmitter under test shall be placed on the support in its standard position and shall be switched on without modulation. If modulation cannot be inhibited then the test shall be carried out with modulation (see clause ~~65.8.1~~ 8.1) and this fact shall be recorded in the test report.

- b) The same method of measurement as steps b) and k) of clause 4.2.4.3.2 shall be used.

4.2.4.3.4 Additional requirements for equipment employing FHSS modulation

Measurements shall be carried out while the equipment is hopping between two frequencies separated by the maximum hop frequency change declared by the manufacturer, one of which is the lowest hop frequency.

The measurements shall be repeated on two frequencies separated by the maximum hop frequency change declared by the manufacturer, one of which is the highest hop frequency.

4.2.4.4 Limits

The maximum power limits of any unwanted emissions in the spurious domain are given in table 3.

Table 3: Spurious emissions

Frequency ranges	47 MHz to 74 MHz 87,5 MHz to 108 MHz 174 MHz to 230 MHz 470 MHz to 862 MHz	Other frequencies ≤ 1 000 MHz	Frequencies > 1 000 MHz
State			
Operating	4 nW	250 nW	1 μW
Standby	2 nW	2 nW	20 nW

4.2.4.5 Conformance

The ~~power level~~ of unwanted emissions in the spurious domain shall be ~~performed~~measured as described in clause 4.2.4.3 and not exceed the limits in clause 4.2.4.4. ~~The values and measurement method utilized shall be stated in the test report.~~

4.2.5 Duty cycle

4.2.5.1 Applicability

Duty Cycle (DC) shall apply to all transmitting equipment except those which utilize Listen Before Talk (LBT) clause 4.4.2, or Detect And Avoid (DAA) clause 4.4.3.

RFID transmitters operating in the 2 446 MHz to 2 454 MHz frequency band that transmit at a maximum radiated peak power level of less than 500 mW e.i.r.p. are also excluded.

For equipment utilizing table B.1 bands C or E, with a radiated power of less than 100 uW e.i.r.p., no duty cycle is specified.

4.2.5.2 Description

Duty cycle is the ratio expressed as a percentage, of the cumulative duration of transmissions T_{on_cum} within an observation interval T_{obs} . $DC = \left(\frac{T_{on_cum}}{T_{obs}} \right)_{F_{obs}}$ on an observation bandwidth F_{obs} .

Unless otherwise specified, T_{obs} is 1 hour and the observation bandwidth F_{obs} is the operational frequency band. Each transmission consists of an RF emission, or sequence of RF emissions separated by intervals $< T_{Dis}$.

An equipment may operate on several bands simultaneously (i.e. multi transmissions), Duty Cycle of each band applies to each transmission.

In case of a multicarrier modulation in a band, the duty cycle applies to the whole signal used for a transmission (e.g. OFDM).

It has to be noted that on some bands Duty Cycle value may depend on the presence of a primary radio service.

Equipment may be triggered manually, by internal timing or by external stimulus. Depending on the method of triggering the timing may be predictable or random.

4.2.5.3 Method of measurement

An assessment of the overall Duty Cycle shall be made for a representative period of T_{obs} over the observation bandwidth F_{obs} . Unless otherwise specified, T_{obs} is 1 hour and the observation bandwidth F_{obs} is the operational frequency band.

The representative period shall be the most active one in normal use of the device. As a guide "Normal use" is considered as representing the behaviour of the device during transmission of 99 % of the [emissions] generated during its operational lifetime.

Procedures such as setup, commissioning, and maintenance are not considered part of normal operation.

For manual operated or event dependant devices, with or without software controlled functions, the manufacturer shall declare whether the device once triggered, follows a pre-programmed cycle, or whether the transmitter remains on until the trigger is released or the device is manually reset. The manufacturer shall also give a description of the application for the device and include a typical usage pattern. The typical usage pattern as declared by the manufacturer shall be used to determine the duty cycle and compare to the limit in table 4.

Where an acknowledgement is required, the additional transmitter on-time shall be included ~~and declared by the manufacturer.~~

4.2.5.4 Limits

Table 4 defines the maximum duty cycle within a 1 hour period.

Table 4: Duty cycle limits

Frequency Band	Duty cycle	Application	Notes
2 400 MHz to 2 483,5 MHz	No Restriction	Generic use	
2 400 MHz to 2 483,5 MHz	No Restriction	Detection, movement and alert applications Radiodetermination	
(a) 2 446 MHz to 2 454 MHz	No Restriction	RFID	Limits shown in annex D <u>Annex G</u> shall apply
(b) 2 446 MHz to 2 454 MHz	≤ 15 %	RFID	Limits shown in annex D <u>Annex G</u> shall apply
5 725 MHz to 5 875 MHz	No Restriction	Generic use	
9 200 MHz to 9 500 MHz	No Restriction	Radiodetermination: radar, detection, movement and alert applications	
9 500 MHz to 9 975 MHz	No Restriction	Radiodetermination: radar, detection, movement and alert applications	
10,5 GHz to 10,6 GHz	No Restriction	Radiodetermination: radar, detection, movement and alert applications	
13,4 GHz to 14,0 GHz	No Restriction	Radiodetermination: radar, detection, movement and alert applications	
17,1 GHz to 17,3 GHz	DAA or equivalent techniques	Radiodetermination: limited to GBSAR detecting and movement and alert applications	Limits shown in annex F <u>Annex I</u> shall apply
24,00 GHz to 24,25 GHz	No Restriction	Generic use and for Radiodetermination: radar, detection, movement and alert applications radiodetermination	
NOTE: The spectrum ranges in some entries are not harmonised throughout all EU territory, specifically entries 4, 9, and 11 have been identified as such. Implementers are cautioned to refer to <u>CEPT/ERC Recommendation 70-03 [i.2]</u> as well as current National Radio plans to verify acceptance within intended regions of use.			

For devices with a 100 % duty cycle transmitting an unmodulated carrier most of the time, a time-out shut-off facility shall be implemented in order to improve the efficient use of spectrum. ~~The method of implementation shall be declared by the manufacturer.~~

4.2.5.5 Conformance

Equipment that ~~does not use LBT~~ requires duty cycle per clause 4.2.5.1 shall not exceed the duty cycle limits provided in table 4. ~~The assessment of clause 4.2.5.3 shall be included in the test report.~~

~~When making transmitter tests on equipment designed for intermittent operation, the~~ NOTE: The maximum duty cycle of the transmitter, as declared by the manufacturer, shall under test should not be exceeded. ~~The actual duty cycle used shall be recorded and stated in the test report.~~

~~NOTE: The maximum duty cycle of the transmitter under test should not be confused with the duty cycle of the equipment under normal operating conditions.~~

~~When performing transmitter tests on equipment designed for intermittent operation it may be necessary to exceed the duty cycle associated with normal operation. Where this is the case, care should be taken to avoid heating effects having an adverse effect on the equipment and the parameters being measured. The maximum transmit on time shall be stated by the test laboratory where applicable. This on time shall not be exceeded and details shall be stated in the test report.~~

confused with the duty cycle of the equipment under normal operating conditions.

4.2.6 Additional requirements for FHSS equipment

4.2.6.1 Applicability

The requirements in this clause apply only to equipment using FHSS modulation.

4.2.6.2 Description

Equipment employing FHSS shall transmit over multiple channels by moving its transmission frequency from channel to channel.

4.2.6.3 Method of measurement

There shall be a declaration of the total number of hops, the dwell time, the bandwidth per hop and the maximum separation of hops.

4.2.6.4 Limits

FHSS modulation shall make use of at least 20 channels hopping over > 90 % of the assigned frequency band.

The dwell time per channel shall not exceed 1 s. While the equipment is operating (transmitting and/or receiving) each channel of the hopping sequence shall be occupied at least once during a period not exceeding four times the product of the dwell time per hop and the number of channels.

4.2.6.5 Conformance

The total number of hops, the dwell time, the bandwidth per hop and the maximum separation of hops measurements shall be performed as described in clause 4.2.6.3 and not exceed the limits in clause 4.2.6.4. The values and measurement method utilized shall be stated in the test report.

4.3 Receiver requirements

4.3.1 Receiver category

The product family of short range radio devices is divided into three receiver categories, see table 5, each having a set of relevant receiver requirements and minimum performance criteria. The set of receiver requirements depends on the choice of receiver category by the equipment manufacturer.

The manufacturer shall specify the receiver category of his choice ~~and if receiver category 1 or 2 is selected, this shall be declared in the product literature provided to the user.~~ In particular, manufacturers and users should pay particular

attention to the potential for interference from other systems operating in the same or adjacent bands for any SRD which may have inherent safety of human life implications.

The receiver categories are defined in table 5.

Table 5: Receiver categories

Receiver category	Relevant receiver clauses	Risk assessment of receiver performance
1	4.3.3, 4.3.4 and 4.3.5	Highly reliable SRD communication media; e.g. serving human life inherent systems (may result in a physical risk to a person).
2	4.3.4 and 4.3.5	Medium reliable <u>reliability</u> SRD communication media e.g. causing inconvenience to persons, which cannot simply be overcome by other means.
3	<u>4.3.4 and 4.3.5</u>	Standard reliable <u>reliability</u> SRD communication media e.g. and radiodetermination devices. E.g. Inconvenience to persons, which can simply be overcome by other means (e.g. - manual).

~~If receiver category Receiver Category 1 or 2 is selected, this shall be stated in both the test report and in the user's manual used for the all equipment using LBT or DAA for interference mitigation. .~~

Receiver category 2 may be required for specific spectrum access techniques are specified in clause-4.4.1.

4.3.2 General performance criteria

For the purpose of the receiver performance tests, the receiver shall produce an appropriate output under normal conditions as indicated below:

- a SND/ND ratio of 20 dB, measured at the receiver output through a telephone psophometric weighting network as described in Recommendation ITU-T O.41 [4]; or
- after demodulation, a data signal with a bit error ratio of 10^{-2} without correction; or
- after demodulation, a message acceptance ratio of 80 %; or
- an appropriate false alarm rate or sensing criteria as declared by the manufacturer.

~~Where the indicated performance cannot be achieved, the performance criteria used to determine the performance of the receiver shall be declared and published by the manufacturer.~~

Unless otherwise specified, the measurements shall be performed using normal operation of the equipment with the equipment operating in accordance utilizing the worst-case configuration with regards to the requirement to be tested. For each of the requirements in the present document, this worst-case configuration shall be declared by the manufacturer and documented in the test report to assure that the equipment is performing in accordance with its intended use. Special software or other alternative methods may be used to operate the equipment in this mode.

4.3.3 Adjacent channel selectivity

4.3.3.1 Applicability

This requirement applies to ~~Equipment~~ channelized Category 1 receivers, ~~when invoked, as defined in clause 4.3.1.~~

4.3.3.2 Description

The adjacent channel selectivity is a measure of the capability of the receiver to operate satisfactorily in the presence of an unwanted signal that differs in frequency from the wanted signal by an amount equal to the adjacent channel separation for which the equipment is intended.

4.3.3.3 Method of measurement

This measurement shall be conducted under normal conditions.

Two signal generators A and B shall be connected to the receiver via a combining network to the receiver, either:

- a) via a test fixture or a test antenna to the receiver integrated, dedicated or test antenna; or
- b) directly to the receiver permanent or temporary antenna connector.

The method of coupling to the receiver shall be stated in the test report.

Signal generator A shall be at the nominal frequency of the receiver, with normal modulation of the wanted signal. Signal generator B shall be unmodulated and shall be adjusted to the adjacent channel centre frequency immediately above that of the wanted signal.

Initially signal generator B shall be switched off and using signal generator A the level that still gives sufficient response shall be established. The output level of generator A shall then be increased by 3 dB.

Signal generator B is then switched on and adjusted until the wanted criteria are met. This level shall be recorded.

The measurements shall be repeated with signal generator B unmodulated and adjusted to the adjacent channel centre immediately below the wanted signal.

The adjacent channel selectivity shall be recorded for the upper and lower adjacent channels as the level in dBm of the unwanted signal.

For tagging systems (e.g. RF identification, anti-theft, access control, location and similar systems) signal generator A may be replaced by a physical tag positioned at 70 % of the measured system range in metres.

In this case, the adjacent selectivity shall be recorded as the level in dBm of lowest level of the unwanted signal (generator B) resulting in a non-read of the tag.

4.3.3.4 Limits

The adjacent channel selectivity of the equipment under specified conditions shall not be less than ~~the levels of the unwanted signal as stated in table 6~~ $-30 \text{ dBm} + k$.

Table 6: Limit for adjacent channel selectivity

Receiver category	Limit
1	$-30 \text{ dBm} + k$
2	No limit
3	No limit

The correction factor, k , is as follows:

~~$$k = 20 \log f - 10 \log BW$$~~

$$k = -20 \log f - 10 \log BW$$

Where:

- f is the frequency in GHz;
- BW is the channel bandwidth in MHz.

The factor k is limited within the following:

- $0 - 40 \text{ dB} < k < 400 \text{ dB}$.

The measured adjacent channel selectivity shall be stated in the test report.

4.3.3.5 Conformance

The adjacent channel selectivity measurements shall be performed as described in clause 4.3.3.3 and not exceed the limits in clause 4.3.3.4. The values and measurement method utilized shall be stated in the test report.

4.3.4 Blocking or desensitization

4.3.4.1 Applicability

This requirement applies to ~~Equipment~~ all Category 1, 2, and ~~Category 23 SRD communication media receivers, when invoked, as defined in clause 4.3.1.~~

4.3.4.2 Description

Blocking is a measure of the capability of the receiver to receive a wanted modulated signal without exceeding a given degradation due to the presence of an unwanted input signal at any frequencies other than those of the spurious responses or the ~~adjacent channels or bands, see clauses 4.3.3 and 4.3.4~~ occupied bandwidth.

4.3.4.3 Methods of measurement

This measurement shall be conducted under normal conditions.

Two signal generators A and B shall be connected to the receiver via a combining network to the receiver, either:

- a) via a test fixture or a test antenna to the receiver integrated, dedicated or test antenna; or
- b) directly to the receiver permanent or temporary antenna connector.

The method of coupling to the receiver shall be stated in the test report.

Signal generator A shall be at the nominal frequency of the receiver, with normal modulation of the wanted signal. Signal generator B shall be unmodulated and shall be adjusted to a test frequency at approximately 10 times, 20 times and 50 times of the receive channel occupied bandwidth above upper band edge of the receive channel occupied bandwidth.

Initially signal generator B shall be switched off and using signal generator A the level which still gives sufficient response shall be established. The output level of generator A shall then be increased by 3 dB.

Signal generator B is then switched on and adjusted until the wanted criteria are met. This level shall be recorded.

The measurement shall be repeated with the test frequency for signal generator B at ~~approximately~~ 10 times, 20 times and 50 times of the receive channel occupied bandwidth below the lower band edge of the receive channel occupied bandwidth.

The blocking or desensitization shall be recorded as the level in dBm of lowest level of the unwanted signal (generator B).

For tagging systems (e.g. RF identification, anti-theft, access control, location and similar systems) signal generator A may be replaced by a physical tag positioned at 70 % of the measured system range in metres. In this case, the blocking or desensitization shall be recorded as the ratio in dB of lowest level of the unwanted signal (generator B) resulting in a non-read of the tag. to the declared sensitivity of the receiver +3 dB.

4.3.4.4 Limits

The blocking level, for any frequency within the specified ranges, shall not be less than the values given in table 76, except at frequencies on which spurious responses are found.

Table 76: Limits for blocking or desensitization

Receiver category	Limit
1	-30 dBm + k
2	-45 dBm + k
3	No limit -60 dBm + k

The correction factor, k , is as follows:

$$k = -20 \log f - 10 \log BW$$

Where:

- f is the frequency in GHz;
- BW is the ~~channel~~channel-occupied bandwidth in MHz.

The factor k is limited within the following:

- ~~0~~-40 dB < k < ~~400~~40 dB.

The measured blocking level shall be stated in the test report.

4.3.4.5 Conformance

The blocking or desensitization measurements shall be performed as described in clause 4.3.4.3 and not exceed the limits in clause 4.3.4.4. The values and measurement method utilized shall be stated in the test report.

4.3.5 Spurious radiations

4.3.5.1 Applicability

This requirement applies to all receivers, except receivers used in combination with permanently co-located transmitters continuously transmitting. Co-located is defined as < 3 m. In these cases the receivers will be tested together with the transmitter in operating mode.

4.3.5.2 Description

Spurious radiations from the receiver are components at any frequency, radiated by the equipment and antenna.

The level of spurious radiations shall be measured by either:

- a) their power level in a specified load (conducted spurious emission) and their effective radiated power when radiated by the cabinet and structure of the equipment (cabinet radiation); or
- b) their effective radiated power when radiated by the cabinet and the integral or dedicated antenna, in the case of portable equipment fitted with such an antenna and no permanent RF connector.

4.3.5.3 Method of measurement for spurious radiation

4.3.5.3.0 General Requirements

For measurements above 1 000 MHz the peak value shall be measured using a spectrum analyser. The "max hold" function of a spectrum analyser shall be used. For measurements up to 1 000 MHz the quasi-peak detector set in accordance with the specification of CISPR 16 [41], [2] and [3] shall be used.

4.3.5.3.1 Method of measurement conducted spurious components

~~This method of measurement requirement applies to all receivers having. Spurious emission levels from a permanent antenna connector.~~

transmitter and receiver of full duplex equipment using a common port are measured simultaneously and the test only needs to be conducted once (see clause 4.2.4)." A test load, 50 Ω power attenuator, may be used to protect the measuring receiver (see clause ~~65.8.5~~65.8.5) against damage when testing a receiver combined in one unit with a transmitter.

The measuring receiver used shall have sufficient dynamic range and sensitivity to achieve the required measurement accuracy at the specified limit. The bandwidth of the measuring receiver shall be adjusted until the sensitivity of the measuring receiver is at least 6 dB below the spurious emission limit given in clause 4.3.5.4. This bandwidth shall be recorded in the test report:

- a) The receiver input terminals shall be connected to a measuring receiver having an input impedance of 50 Ω and the receiver is switched on.

- b) For carrier frequencies in the range 1 GHz to 20 GHz the frequency of the measuring receiver shall be adjusted over the frequency range 25 MHz to 10 times the carrier frequency, not exceeding 40 GHz. For carrier frequencies above 20 GHz the measuring receiver shall be tuned over the range 25 MHz up to twice the carrier frequency not exceeding 66 GHz. The frequency and the absolute power level of each of the spurious components found shall be noted.
- c) If the detecting device is not calibrated in terms of power input, the level of any detected components shall be determined by replacing the receiver by the signal generator and adjusting it to reproduce the frequency and level of every spurious component noted in step b). The absolute power level of each spurious component shall be noted.
- d) The frequency and level of each spurious emission measured and the bandwidth of the measuring receiver shall be recorded in the test report.

4.3.5.3.2 Method of measurement cabinet radiation

This method of measurement applies to receivers having a permanent antenna connector:

- a) A test site selected from ~~annex B~~ Annex E which fulfils the requirements of the specified frequency range of this measurement shall be used. The test antenna shall be oriented initially for vertical polarization and connected to a measuring receiver. The bandwidth of the measuring receiver shall be adjusted until the sensitivity of the measuring receiver is at least 6 dB below the spurious emission limit given in clause 4.3.5.4. This bandwidth shall be recorded in the test report.

The receiver under test shall be placed on the support in its standard position and connected to an artificial antenna, see clause 5.8.2.

- b) For carrier frequencies in the range 1 GHz to 20 GHz the frequency of the measuring receiver shall be adjusted over the frequency range 25 MHz to 10 times the carrier frequency, not exceeding 40 GHz. For carrier frequencies above 20 GHz the measuring receiver shall be tuned over the range 25 MHz up to twice the carrier frequency not exceeding 66 GHz. The frequency of each spurious component shall be noted. If the test site is disturbed by radiation coming from outside the site, this qualitative search may be performed in a screened room with reduced distance between the transmitter and the test antenna.
- c) At each frequency at which a component has been detected, the measuring receiver shall be tuned and the test antenna shall be raised or lowered through the specified height range until the maximum signal level is detected on the measuring receiver.
- d) The receiver shall be rotated up to 360° about a vertical axis, to maximize the received signal.
- e) The test antenna shall be raised or lowered again through the specified height range until a maximum is obtained. This level shall be noted.
- f) The substitution antenna (see clause ~~BE~~.3.2) shall replace the receiver antenna in the same position and in vertical polarization. It shall be connected to the signal generator.
- g) At each frequency at which a component has been detected, the signal generator, substitution antenna and measuring receiver shall be tuned. The test antenna shall be raised or lowered through the specified height range until the maximum signal level is detected on the measuring receiver. The level of the signal generator giving the same signal level on the measuring receiver as in step e) shall be noted. This level, after correction due to the gain of the substitution antenna and the cable loss, is the radiated spurious component at this frequency.
- h) The frequency and level of each spurious emission measured and the bandwidth of the measuring receiver shall be recorded in the test report.
- i) Measurements b) to h) shall be repeated with the test antenna oriented in horizontal polarization.

4.3.5.3.3 Method of measurement radiated spurious components

This method of measurement applies to receivers having an integral antenna.

- a) A test site selected from ~~annex B~~ Annex E which fulfils the requirements of the specified frequency range of this measurement shall be used. The test antenna shall be oriented initially for vertical polarization and connected to a measuring receiver. The bandwidth of the measuring receiver shall be adjusted until the

sensitivity of the measuring receiver is at least 6 dB below the spurious emission limit given in clause 4.3.5.4. This bandwidth shall be recorded in the test report.

The receiver under test shall be placed on the support in its standard position.

- b) The same method of measurement as items b) to i) of clause 4.3.5.3.2 shall apply.

4.3.5.4 Limits

The power of any spurious emission shall not exceed 2 nW in the range 25 MHz to 1 GHz and shall not exceed 20 nW on frequencies above 1 GHz.

4.3.5.5 Conformance

The spurious radiations measurements shall be performed as described in clause 4.3.5.3 and not exceed the limits in clause 4.3.5.4. The values and measurement method utilized shall be stated in the test report.

4.4 Spectrum access techniques

4.4.1 Applicability

For equipment with radiated power of less than 100 µW e.i.r.p., no access technique is specified.

For the present document, the following access mechanisms are specified:

- Listen Before Talk (LBT) which is used to share spectrum between SRD transceiver equipment with similar power and bandwidth; or
- 17,1 GHz to 17,3 GHz GBSAR only, Detect And Avoid (DAA) which is used to protect radio communication services.

Receiver Category 2 or better shall be used for all equipment using LBT and/or DAA applications.

~~For equipment with radiated power of less than 100 µW e.i.r.p., no access technique is specified.~~

Equipment utilizing LBT or DAA, do not have to comply with the duty cycle conditions stated in clause ~~4.2.5.~~

For spread spectrum systems, LBT may be used if the required timing and threshold limits can be met; if not, then a duty cycle requirement applies, see clause 4.2.5.

4.4.2 Listen Before Talk (LBT)

4.4.2.0 General

In order to make maximum use of the available channels intelligent or polite equipment may use a Listen Before Talk (LBT) protocol with a preferred option of Adaptive Frequency Agility (AFA). AFA is defined as the capability of equipment to dynamically change channel within its available frequencies for proper operation.

For LBT equipment, the device shall listen on the next intended frequency before transmitting. If it is intended to move to a different channel then this channel can be monitored whilst still transmitting at its first channel. If it is not intended to move to a different channel then it should be treated as a single frequency device waiting for a free channel.

The channel occupancy timings refer to the maximum time a device can transmit on a channel, in any one period, and the minimum "listening" period before the device can retransmit either on the same or, for frequency agile equipment, on another channel.

For a device with LBT some of the receiver parameters become essential requirements under the RE-D [i.1]. The receiver requirements are the following:

- LBT threshold, for further details, see clause 4.4.2.2.
- Blocking or desensitization, for further details, see clause 4.3.4.

Adjacent channel selectivity, see clause 4.3.3, is not a mandatory requirement for non-channelized equipment using LBT. ~~However, it shall be noted~~Implementers should note that while insufficient adjacent channel or signal selectivity will not affect the efficient use of the spectrum, it may reduce the apparent channel availability for the primary device.

~~For spread spectrum systems, LBT may be used if the required timing and threshold limits can be met; if not, then a duty cycle requirement applies, see clause 4.2.5.~~

~~It shall be noted that the use of LBT may be restricted by the dwell time for Frequency Hopping Spread Spectrum systems. In case of fast frequency hopping where the dwell time is shorter than the LBT minimum listening time then a duty cycle requirement applies, see clause 4.2.5.~~

4.4.2.1 LBT timing parameters

4.4.2.1.1 Minimum transmitter off-time

4.4.2.1.1.1 Description

The minimum ~~TX-Tx~~ off-time allows other users with LBT facility to get access to a channel.

The minimum ~~TX-Tx~~ off-time is defined as the period where a specific transmitter shall remain off after a transmission or a communication dialogue between units or a polling sequence of other units.

4.4.2.1.1.2 Limit

The limit for the minimum ~~TX-Tx~~ off-time is > 25 ms.

The ~~TX-Tx~~ off-time shall be declared in the test report by the equipment manufacturer.

4.4.2.1.2 LBT minimum listening time

4.4.2.1.2.1 Description

The minimum listening time is defined as the minimum time that the equipment listens for a received signal at or above the LBT threshold level (see clause 4.4.32.2) immediately prior to transmission to determine whether the intended channel is available for use.

The listening time shall consist of the "minimum fixed listening time" and an additional pseudo random part. If during the listening mode another user is detected on the intended channel, the listening time shall commence from the instant that the intended channel is free again. Alternatively, the equipment may select another channel and again start the listen time before transmission.

It shall be noted that the use of LBT may be restricted by the dwell time for Frequency Hopping Spread Spectrum systems. In case of fast frequency hopping where the dwell time is shorter than the LBT minimum listening time then a duty cycle requirement applies, see clause 4.2.5.

4.4.2.1.2.2 Limit for minimum listening time

The total listen time, t_L , consists of a fixed part, t_F , and a pseudo random part, t_{PS} , as the following:

$$\underline{t_L = t_F + t_{PS}}$$

a) $t_L = t_F + t_{PS}$

a) The fixed part of the minimum listening time, t_F , shall be 5 ms.

b) ~~b)~~ The pseudo random listening time t_{PS} shall be randomly varied between 0 ms and a value of 5 ms or more in equal steps of approximately 0,5 ms as the following:

- If the channel is free from traffic at the beginning of the listen time, t_L , and remains free throughout the fixed part of the listen time, t_F , then the pseudo random part, t_{PS} , is automatically set to zero by the equipment itself.

- If the channel is occupied by traffic when the equipment either starts to listen or during the listen period, then the listen time commences from the instant that the intended channel is free. In this situation the total listen time t_L shall comprise t_F and the pseudo random part, t_{PS} .

The limit for total listen time for the receiver consists of the sum of a) and b) together.

Algorithmic details and values for a) and b) shall be declared by the manufacturer of the equipment.

4.4.2.1.3 Acknowledge transmissions

An acknowledge transmission is defined as a receipt for a received message.

There is no requirement for a listen time before an acknowledge can be performed. However, it shall be noted that if the start of an acknowledge is not received before the end of normal fixed part of the listen time (5 ms) then the channel might be taken by another transmitter.

4.4.2.1.4 Maximum transmitter on-time

4.4.2.1.4.1 Description

A transmitter shall only be allowed to transmit continuously for a maximum specified period. This will prevent a transmitter from occupying a channel for an extended period.

The maximum on-time shall always be as short as possible for the application since SRD applications are often battery operated.

The maximum transmitter on-time is defined as the maximum time the transmitter can be on during:

- a) A single transmission.
- b) Multiple transmissions and acknowledgements for a communication dialogue or polling sequence of other units under the condition that the channel is free.

An equipment intended for very long messages shall be capable of switching to a "free" channel before the maximum transmitter on-time is reached for each channel of operation.

4.4.2.1.4.2 Limit

The limit for a single transmission ~~TX~~T_x on-time is 2 s.

For further information on measurements of maximum transmitter on-time, see clause-4.4.2.2.

The time for the transmission dialogue or a polling sequence shall be less than 10 s.

In the case of the above timing, t, reaches the limit then the minimum ~~TX~~T_x off-time limit shall apply automatically.

4.4.2.1.5 Declaration of LBT parameters

For automatic operated LBT devices, either software controlled or pre-programmed devices, the manufacturer shall declare all the channel LBT timings for the equipment under test.

4.4.2.1.6 ~~Equipment with or without LBT using transmitter time-out-timer~~Manual and event driven devices

For manual operated or event dependant devices, with or without software controlled functions, the manufacturer shall declare whether the transmission once triggered, follows a pre-programmed time-out-timer, or whether the transmitter remains on until the trigger is released or the device is manually reset.

The manufacturer shall also give a description of the application for the device and include a typical usage pattern. The typical usage pattern as declared by the manufacturer shall be used to determine the channel occupancy timings.

4.4.2.2 Receiver LBT threshold and transmitter max on-time

4.4.2.2.0 Applicability

The measurements and limits apply to ~~a transceiver that facilitates a receiver with a~~ equipment which implements an LBT protocol.

4.4.2.2.1 Descriptions

The LBT threshold is defined as the received signal level above which the equipment can determine that the channel is not available for use. If the received signal is below the LBT threshold then the equipment can determine that the channel is available for use.

The definition of the maximum transmitter on-time for equipment with an LBT facility is defined in clause 4.4.2.1.4.1.

4.4.2.2.2 Method of measurements

A signal generator and a power meter are each combined via appropriate attenuators into the equipment antenna connector. The test set-up in figure 3 shall be used.

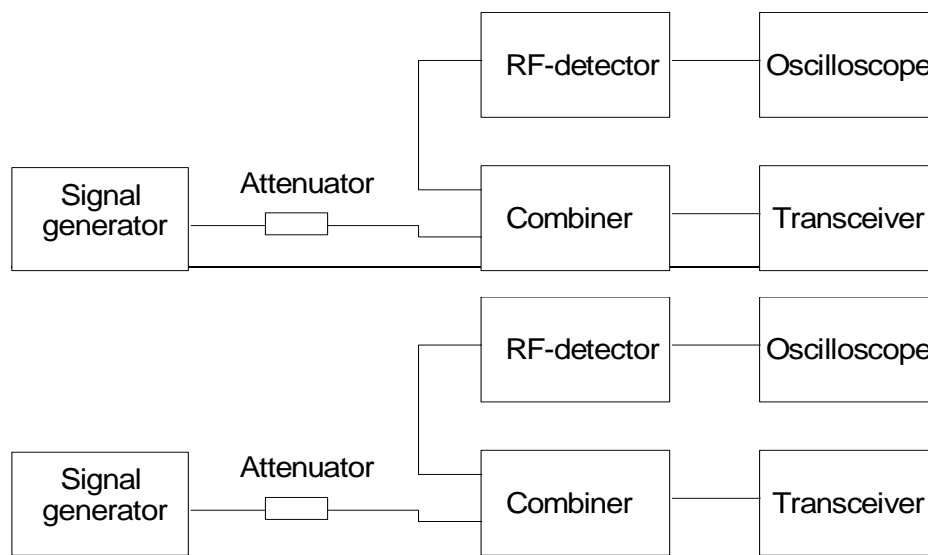

Figure 3: Measurement arrangement

For equipment with integral antenna the connection to the equipment is made either to a temporary 50 Ω antenna connector, see clause 4.5.2.3.1, or via a calibrated test fixture, see clause 5.8.3:

- a) the LBT function of the transceiver shall be active;
- b) the attenuator shall provide sufficient attenuation to protect the signal generator from burn-out by the transmitter of the transceiver;
- c) the signal generator with normal test modulation is adjusted to the receiving frequency. The level is increased to approximately 20 dB above the receiver sensitivity;
- d) the equipment is switched to an intended transmit mode. The equipment shall not be transmitting as the transceiver recognizes a busy channel from the signal generator;
- e) the level of the signal generator is reduced in steps of 1 dB until the equipment starts to transmit. This specific signal generator level present at the receiver input of the transceiver is the LBT threshold;

The level of the received LBT threshold shall be recorded in the test report.

- f) the steps c) and d) shall be repeated; and
- g) the level of the signal generator is reduced in steps of 1 dB until the equipment starts to transmit and the duration of the transmit on-time is measured at the oscilloscope.

The transmit on-time is recorded in the test report.

4.4.2.2.3 Limits

The LBT maximum thresholds for the receiver in listen mode are given in table 87.

Table 87: Receiver LBT threshold limit versus transmit power and channel spacing

T Tx power	< 100 mW	500 mW
LBT threshold	-80 dBm + c	-87 dBm + c
NOTE 1: The limit is independent of the receiver category, see clause 4.4.3.1.		
NOTE 2: The limits are based on an antenna gain of +2 dBi maximum. For other antenna gains greater than +2 dBi the limits shall be adjusted accordingly.		

The correction factor, *c*, is given by the following formula:

$$c = 10 \cdot \log BW$$

Where:

- *BW* is the bandwidth in MHz.

The limits for Tx max on-time are as stated in clause 4.4.2.1.4.2.

4.4.2.2.4 Conformance

The measured LBT threshold shall be less than the limits given table 87 and stated in the test report.

The receiver LBT threshold and Tx max on-time measurements shall be performed as described in clause 4.4.2.2.2 and not exceed the limits in clause 4.4.2.2.3. The values and measurement method utilized shall be stated in the test report.

4.4.3 Detect And Avoid techniques (DAA)

4.4.3.1 General requirements

DAA is specified for use with Ground Based Synthetic Aperture Radar (GBSAR) systems. It provides protection to other radio communication services by utilizing the following parameters:

- a) Receiver minimum listen time before the transmitter can be switched on, immediately prior to any intended transmission.
- b) Receiver detect and avoid threshold.
- c) An appropriate long listen-time after detection of a service to be protected is detected.
- d) Maximum transmitter on-time without interruption.
- e) Minimum transmitter off-time after a transmitter on-time period.

It shall be noted that DAA can only be applied if the SRD equipment is using a common antenna for both receive and transmit, or the same antenna type is used for both receive and transmit with both antennas pointing in the same direction.

The DAA function and limits are depending ~~on~~ on the services to be protected. Requirements for the implementation of Detect And Avoid (DAA) technique for Ground Based Synthetic Aperture Radar (GBSAR) systems operating in the frequency range 17,1 GHz to 17,3 GHz are given in ~~annex F~~ Annex I.

4.4.4 Adaptive Frequency Agility (AFA)

4.4.4.1 General requirements

SRD equipment with LBT or DAA may also employ an Adaptive Frequency Agility (AFA) function to:

- avoid co-channel operation with other systems after detection of interference from these other systems;

- where possible, provide on aggregate a uniform loading of the spectrum across all devices.

The equipment shall only use the channels dedicated for the application.

Additionally, the equipment shall either follow the restrictions for LBT given in clause 4.4.2 or the restrictions for DAA as appropriate.

4.5 2,45 GHz RFID systems

~~Power limits for~~ RFID systems operating in the 2,45 GHz band as defined in ~~annex D~~ Annex G, shall not exceed the limits as defined in clause ~~D~~ G.1.

4.6 GBSAR systems

4.6.1 Effective radiated power

The equivalent isotropically radiated power, as defined in clause ~~F~~ I.2.1, shall not exceed the limits in clause ~~F~~ I.2.3.

4.6.2 Permitted range of operating frequencies

The permitted range of operation frequencies, as defined in clause ~~F~~ I.3.1, shall not exceed the limits in clause ~~F~~ I.3.3.

4.6.3 DAA threshold

4.6.3.0 General requirements

The DAA threshold, as defined in clause ~~F~~ I.4.3.1, shall not exceed the limits in clause ~~F~~ I.4.3.3.

4.6.3.1 DAA timing parameters

4.6.3.1.1 Minimum listen time

The minimum listen time, as defined in clause ~~F~~ I.4.4.1.1, shall not exceed the limits in clause ~~F~~ I.4.4.1.3.

4.6.3.1.2 Minimum listen time after detection

The DAA threshold, as defined in clause ~~F~~ I.4.4.2.1, shall not exceed the limits in clause ~~F~~ I.4.4.2.3.

4.6.3.1.3 Maximum transmitter on-time

The maximum transmitter on-time, as defined in clause ~~F~~ I.4.4.3.1, shall not exceed the limits in clause ~~F~~ I.4.4.3.3.

4.6.3.1.4 Minimum transmitter off-time

The minimum transmitter off-time, as defined in clause ~~F~~ I.4.4.4.1, shall not exceed the limits in clause ~~F~~ I.4.4.4.3.

4.6.4 Antenna pattern

The antenna pattern, as defined in clause ~~F~~ I.5.1, shall not exceed the limits in clause ~~F~~ I.5.3.

5 Testing for compliance with technical requirements

5.1 Environmental conditions for testing

Tests defined in the present document shall be carried out at representative points within the boundary limits of the declared operational environmental profile.

Where technical performance varies subject to environmental conditions, tests shall be carried out under a sufficient variety of environmental conditions (within the boundary limits of the declared operational environmental profile) to give confidence of compliance for the affected technical requirements.

5.2 Presentation of equipment for testing purposes

5.2.0 General

~~Where applicable, equipment submitted for testing shall fulfil the requirements of the present document on all frequencies over which it is intended to operate.~~

~~Where appropriate, testing should be carried out on suitable frequencies for the equipment concerned.~~

Additionally, technical documentation and operating manuals, sufficient to allow testing to be performed, shall be available.

A test fixture for equipment with an integral antenna may be supplied (see clause 5.8.3).

To simplify and ~~harmonize~~ harmonise the testing procedures between the different testing laboratories, measurements shall be performed according to the present document on samples of equipment defined in clauses 5.2.1 to 5.2.3.2.

These clauses are intended to give confidence that the requirements set out in the present document have been met without the necessity of performing measurements on all frequencies.

5.2.1 Choice of model for testing

One or more samples of the equipment, as appropriate, shall be tested.

Standalone equipment shall be tested complete with any ancillary equipment needed for testing.

If equipment has optional features considered not to affect the RF parameters, then the tests need only to be performed on the equipment configured with that combination of features considered to be the most complex. Where practicable, equipment offered for testing shall provide a 50 Ω connector for conducted RF power measurements.

In the case of integral antenna equipment, if the equipment does not have an internal permanent 50 Ω connector then it is permissible to supply a second sample of the equipment with a temporary 50 Ω antenna connector fitted to facilitate testing, see clause 5.2.3.

5.2.2 Testing of equipment with alternative power levels

If a family of equipment has alternative output power levels provided by the use of separate power modules or add on stages, or additionally has alternative frequency coverage, then all these shall be declared. Each module or add on stage shall be tested in combination with the equipment. The necessary samples and tests shall be based on the requirements of clause 5.2. As a minimum, measurements of the radiated power (e.i.r.p.) and spurious emissions shall be performed for each combination and shall be stated in the test report.

5.2.3 Testing of equipment that does not have an external 50 Ω RF connector (integral antenna equipment)

5.2.3.1 Equipment with an internal permanent or temporary antenna connector or using a dedicated test fixture

The means to access and/or implement the internal permanent or temporary antenna connector shall be stated with the aid of a diagram. Alternately, a suitable test fixture may be provided by the manufacturer. The fact that use has been made of the internal antenna connection, or of a temporary connection, or a suitable test fixture to facilitate measurements shall be recorded in the test report.

For further information on the test fixture, see clause 5.8.3.

5.2.3.2 Equipment with a temporary antenna connector

One set of equipment, with the normal antenna connected, may be tested to enable radiated measurements to be made. The manufacturer shall attend the test laboratory at the conclusion of the radiated measurements, to disconnect the antenna and fit the temporary connector. The testing laboratory staff shall not connect or disconnect any temporary antenna connector.

Alternatively, two sets of equipment may be submitted to the test laboratory, one fitted with a temporary antenna connector with the antenna disconnected and another equipment with the antenna connected. Each equipment shall be used for the appropriate tests. There shall be a declaration that the two sets of equipment are identical in all aspects except for the antenna connector.

5.2.4 Testing of devices using duty cycle

When making transmitter tests on equipment designed for intermittent operation the maximum duty cycle of the transmitter shall not be exceeded. The actual duty cycle used shall be recorded and stated in the test report.

NOTE: The maximum duty cycle of the transmitter under test should not be confused with the duty cycle of the equipment under normal operating conditions.

When performing transmitter tests on equipment designed for intermittent operation it may be necessary to exceed the duty cycle associated with normal operation. Where this is the case, care should be taken to avoid heating effects having an adverse effect on the equipment and the parameters being measured. The maximum transmit on-time shall be stated by the test laboratory where applicable. This on-time shall not be exceeded and details shall be stated in the test report.

5.3 Mechanical and electrical design

5.3.1 General

Transmitters and receivers may be individual or combination units.

5.3.2 ~~Controls~~Void

~~Those controls which, if maladjusted, might increase the interfering potentialities of the equipment shall not be easily accessible to the user.~~

5.3.3 Transmitter shut-off facility

If the transmitter is equipped with an automatic transmitter shut-off facility, it should be made inoperative for the duration of the test. In the case this not possible, a proper test method shall be described and documented.

5.3.4 Receiver mute or squelch

If the receiver is equipped with a mute, squelch or battery-saving circuit, this circuit shall be made inoperative for the duration of the tests. In the case this not possible, a ~~proper~~ test method shall be described and documented.

5.4 Auxiliary test equipment

All ~~necessary~~ special-to-type test signal sources and set-up information shall accompany the equipment when it is submitted for testing.

5.5 Test power source

5.5.0 General

The equipment shall be tested using the appropriate test power source as specified in clauses 5.5.1 or 5.5.2. Where equipment can be powered using either external or internal power sources, then the equipment shall be tested using the external power source as specified in clause 5.5.1 then repeated using the internal power source as specified in clause 5.5.2.

The test power source used shall be stated in the test report.

5.5.1 External test power source

During testing, the power source of the equipment shall be replaced by an external test power source capable of producing normal and extreme test voltages as specified in clauses 5.5.6.2 and 5.6.7.2. The internal impedance of the external test power source shall be low enough for its effect on the test results to be negligible. For the purpose of the tests, the voltage of the external test power source shall be measured at the input terminals of the equipment. The external test power source shall be suitably de-coupled and applied as close to the equipment battery terminals as practicable. For radiated measurements, any external power leads should be so arranged so as not to affect the measurements.

During tests, the test power source voltages shall be within a tolerance of $< \pm 1$ % relative to the voltage at the beginning of each test. The value of this tolerance can be critical for certain measurements. Using a smaller tolerance will provide a better uncertainty value for these measurements.

5.5.2 Internal test power source

For radiated measurements on portable equipment with integral antenna, fully charged internal batteries should be used. The batteries used should be as supplied or recommended by the manufacturer. If internal batteries are used, at the end of each test the voltage shall be within a tolerance of $< \pm 5$ % relative to the voltage at the beginning of each test. Where this is not appropriate, a note to this effect shall be appended to the test report.

If appropriate, for conducted measurements or where a test fixture is used, an external power supply at the required voltage may replace the supplied or recommended internal batteries. This shall be stated on the test report.

5.6 Normal test conditions

5.6.1 Normal temperature and humidity

The normal temperature and humidity conditions for tests shall be any convenient combination of temperature and humidity within the following ranges:

- temperature $+15$ °C to $+35$ °C;
- relative humidity 20 % to 75 %.

When it is impracticable to carry out tests under these conditions, a note to this effect, stating the ambient temperature and relative humidity during the tests, shall be added to the test report.

5.6.2 Normal test power source

5.6.2.1 Mains voltage

The normal test voltage for equipment to be connected to the mains shall be the nominal mains voltage. For the purpose of the present document, the nominal voltage shall be the declared voltage, or any of the declared voltages, for which the equipment was designed.

The frequency of the test power source corresponding to the ac mains shall be between 49 Hz and 51 Hz.

5.6.2.2 Battery power sources

When the radio equipment is intended for operation with the usual types of battery power source, the normal test voltage shall be 1,1 multiplied by the nominal voltage of the battery (e.g. 6 V, 12 V, etc.).

5.6.2.3 Other power sources

For operation from other power sources or types of battery (primary or secondary), the normal test voltage shall be that declared by the equipment manufacturer and agreed to by the accredited test laboratory. Such values shall be stated in the test report.

5.7 Extreme test conditions

5.7.1 Extreme temperatures

5.7.1.1 Procedure for tests at extreme temperatures

5.7.1.1.0 General

Before measurements are made the equipment shall have reached thermal balance in the test chamber. The equipment shall be switched off during the temperature stabilizing period.

In the case of equipment containing temperature stabilization circuits designed to operate continuously, the temperature stabilization circuits shall be switched on for 15 minutes after thermal balance has been obtained, and the equipment shall then meet the specified requirements.

If the thermal balance is not checked by measurements, a temperature stabilizing period of at least one hour, or such period as may be decided by the accredited test laboratory, shall be allowed. The sequence of measurements shall be chosen, and the humidity content in the test chamber shall be controlled so that excessive condensation does not occur.

5.7.1.1.1 Procedure for equipment designed for continuous operation

If the manufacturer states that the equipment is designed for continuous operation, the test procedure shall be as follows:

- before tests at the upper extreme temperature the equipment shall be placed in the test chamber and left until thermal balance is attained. The equipment shall then be switched on in the transmit condition for a period of a half hour after which the equipment shall meet the specified requirements;
- for tests at the lower extreme temperature, the equipment shall be left in the test chamber until thermal balance is attained, then switched on for a period of one minute after which the equipment shall meet the specified requirements.

5.7.1.1.2 Procedure for equipment designed for intermittent operation

If the manufacturer states that the equipment is designed for intermittent operation, the test procedure shall be as follows:

- before tests at the upper extreme temperature the equipment shall be placed in the test chamber and left until thermal balance is attained in the oven. The equipment shall then either:
 - transmit on and off according to the manufacturers declared duty cycle for a period of five minutes; or
 - if the manufacturer's declared on period exceeds one minute, then:
 - transmit in the on condition for a period not exceeding one minute, followed by a period in the off or standby mode for four minutes; after which the equipment shall meet the specified requirements;
- for tests at the lower extreme temperature, the equipment shall be left in the test chamber until thermal balance is attained, then switched to the standby or receive condition for one minute after which the equipment shall meet the specified requirements.

5.7.1.2 Extreme temperature ranges

For tests at extreme temperatures, measurements shall be made in accordance with the procedures specified in clause 5.47.1.1, at the upper and lower temperatures of one of the following ranges, either:

- a) the temperature range as declared by the manufacturer; or
- b) one of the following specified temperature ranges:
 - Temperature category I (General): -20 °C to +55 °C;
 - Temperature category II (Portable): -10 °C to +55 °C;

- Temperature category III (Equipment for normal indoor use): 5 °C to +35 °C.

The test report shall state which range is used.

5.7.2 Extreme test source voltages

5.7.2.1 Mains voltage

The extreme test voltages for equipment to be connected to an ac mains source shall be the nominal mains voltage $\pm 10\%$. For equipment that operates over a range of mains voltages clause 5.7.2.4 applies.

5.7.2.2 Battery power sources

When the radio equipment is intended for operation from the usual type of battery power sources the extreme test voltages shall be 1,3 and 0,9 multiplied by the nominal voltage of the battery (6 V, 12 V, etc.).

For float charge applications using "gel-cell" type batteries the extreme voltage shall be 1,15 and 0,85 multiplied by the nominal voltage of the declared battery voltage.

5.7.2.3 Power sources using other types of batteries

The lower extreme test voltages for equipment with power sources using batteries shall be as follows:

- for equipment with a battery indicator, the end point voltage as indicated;
- for equipment without a battery indicator the following end point voltages shall be used:
 - for the Leclanché or the lithium type of battery:
 - 0,85 multiplied by the nominal voltage of the battery.
 - for the nickel-cadmium type of battery:
 - 0,9 multiplied by the nominal voltage of the battery.
- for other types of battery or equipment, the lower extreme test voltage for the discharged condition shall be declared by the equipment manufacturer.

The nominal voltage is considered to be the upper extreme test voltage in this case.

5.7.2.4 Other power sources

For equipment using other power sources, or capable of being operated from a variety of power sources, the extreme test voltages shall be those agreed between the equipment manufacturer and the test laboratory. This shall be recorded in the test report.

5.8 General conditions

5.8.1 Normal test signals and test modulation

5.8.1.0 General

The test modulating signal is a signal which modulates a carrier, is dependent upon the type of equipment under test and also the measurement to be performed. Modulation test signals only apply to products with an external modulation connector.

Test signals may be generated by applying test baseband signals to a modulation port on the device or be generated internally by the device. Operation in a test mode may involve suitable temporary internal modifications of the equipment under test or the use of special software. Details of the method employed shall be declared by the manufacturer and be recorded in the test report.

Where appropriate, a test signal shall be used with the following characteristics:

- representative of normal operation;

- causes greatest occupied RF bandwidth.

For equipment using intermittent transmissions the test signal shall be such that:

- the generated RF signal is the same for each transmission;
- transmissions occur regularly in time;
- sequences of transmissions can be accurately repeated.

Details of the test signal shall be recorded in the test report.

If there is no provision for external test modulation, then normal operating modulation shall be used. For narrow band speech (≤ 120 kHz RF bandwidth) an unmodulated signal shall be used.

5.8.1.1 Normal test signals for data

Where the equipment has an external connection for general data modulation, the normal test signals are specified as follows:

- D-M2: a test signal representing a pseudo-random bit sequence of at least 511 bits in accordance with Recommendation ITU-T O.153 [5]. This sequence shall be continuously repeated. If the sequence cannot be continuously repeated, the actual method used shall be stated in the test report.
- D-M3: a test signal shall be agreed between the test laboratory and the manufacturer in case selective messages are used and are generated or decoded within the equipment.
The agreed test signal may be formatted and may contain error detection and correction.

5.8.2 Artificial antenna

Where applicable, tests shall be carried out using an artificial antenna which shall be a substantially non-reactive non-radiating load connected to the antenna connector. The Voltage Standing Wave Ratio (VSWR) at the 50Ω connector or the manufacturer's specified test fixture shall not be greater than 1,5:1 over the frequency range of the measurement.

5.8.3 Test fixture

5.8.3.0 General

With equipment intended for use with a small aperture integral antenna, and not equipped with a 50Ω RF output connector, a suitable test fixture may be used. An example test fixture is shown in figure 4.

This fixture is a radio frequency device for coupling the integral antenna to a 50Ω RF terminal at all frequencies for which measurements need to be performed.

The test fixture shall be fully described.

In addition, the test fixture may provide:

- a connection to an external power supply;
- a method to provide the input to or output from the equipment. This may include coupling to or from the antenna. In case of assessment of speech equipment, an audio interface may be provided by direct connection or by an acoustic coupler or in case of non-speech equipment, the test fixture could also provide the suitable coupling means e.g. for data or video outputs.

The test fixture shall normally be supplied by the manufacturer.

The performance characteristics of the test fixture shall be approved by the testing laboratory and shall conform to the following basic parameters:

- the coupling loss shall not be greater than 30 dB;
- adequate bandwidth properties;

- c) a coupling loss variation over the frequency range used in the measurement which does not exceed 2 dB;
- d) circuitry associated with the RF coupling shall contain no active or non-linear devices;
- e) the VSWR at the 50 Ω socket shall not be more than 1,5 over the frequency range of the measurements;
- f) the coupling loss shall be independent of the position of the test fixture and be unaffected by the proximity of surrounding objects or people. The coupling loss shall be reproducible when the equipment under test is removed and replaced. Normally, the test fixture is in a fixed position and provides a location for the EUT;
- g) the coupling loss shall remain substantially constant when the environmental conditions are varied.

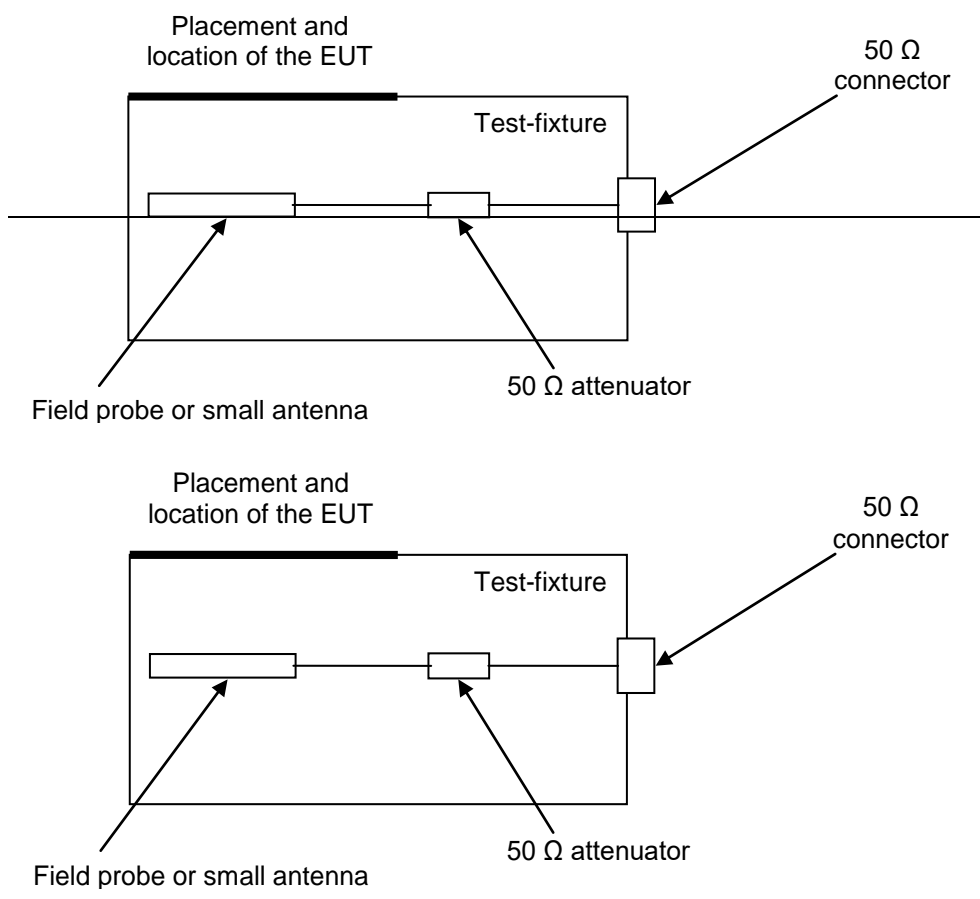

Figure 4: Test fixture

The field probe (or small antenna) needs to be properly terminated.

The characteristics and validation shall be included in the test report.

5.8.3.1 Validation of the test-fixture in the temperature chamber

The test fixture is brought into a temperature chamber (only needed if test fixture measurements performed under extreme temperature conditions).

Step 1:

A transmit antenna connected to a signal generator shall be positioned from the test-fixture at a far field distance of not less than one λ at the frequency. The test fixture consists of the mechanical support for the EUT, an antenna or field probe and a 50 Ω attenuator for proper termination of the field probe. The test fixture shall be connected to a spectrum analyser via the 50 Ω connector. A signal generator shall be set on the EUT's nominal frequency (see figure 5). The unmodulated output power of the signal generator shall be set to a value such that a sufficiently high level can be observed with the spectrum analyser. This determined value shall be recorded. The signal generator shall then be set to the upper and the lower band limit of the EUT's assigned frequency band. The measured values shall not deviate more than 1 dB from the value at the nominal frequency.

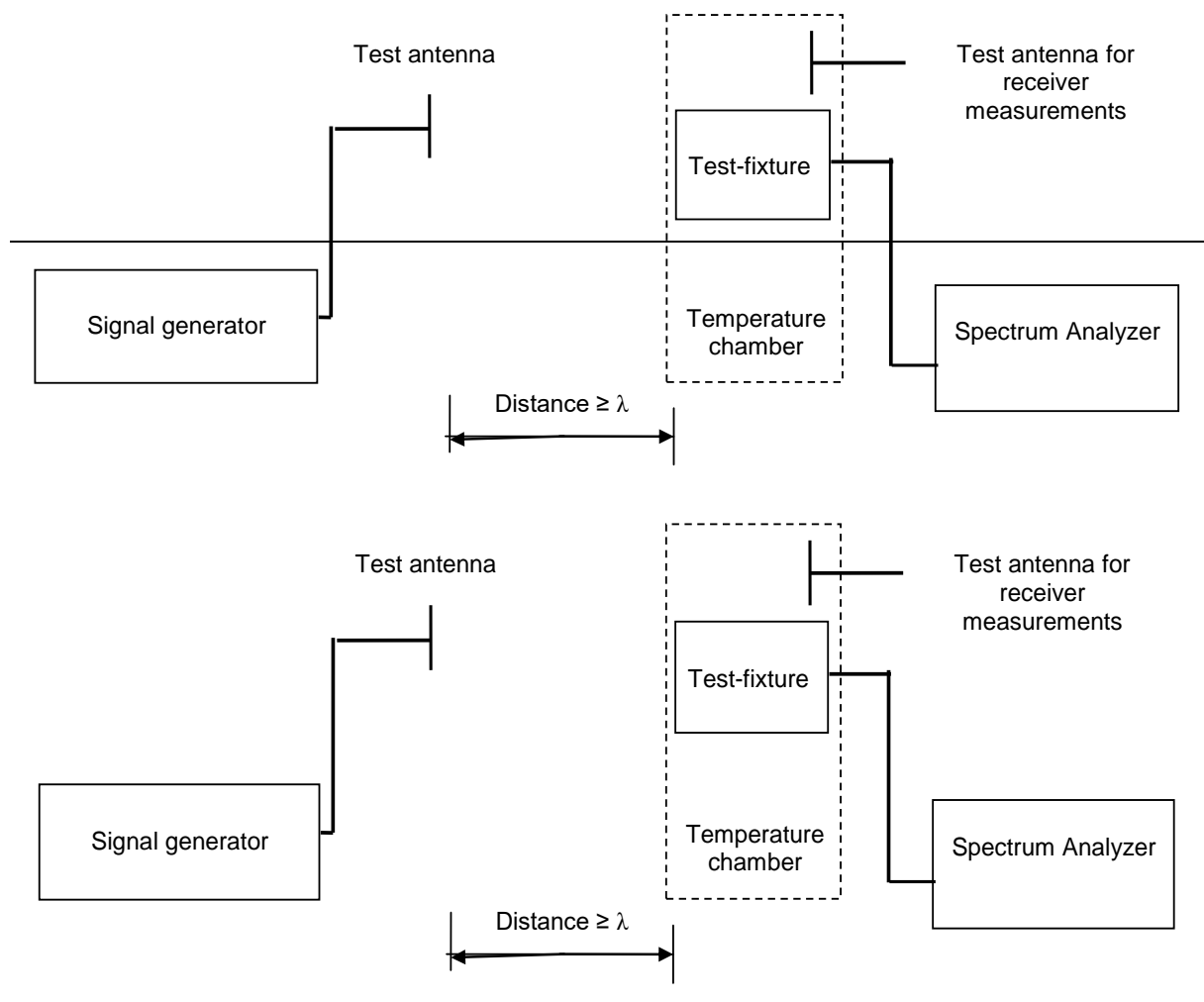

Figure 5: Validation of test set-up without EUT

If receiver tests under extreme temperature conditions are performed, a receiver test antenna is also brought into the temperature chamber to ensure its influence in the chamber is known.

Step 2:

During validation and testing the EUT shall be fitted to the test fixture in a switched-off mode, see figure 6. Step 1 shall be repeated, this time with the EUT in place. The measured values shall be compared with those from step 1 and shall not vary by more than 2 dB. This shows that the EUT does not cause any significant shadowing of the radiated power.

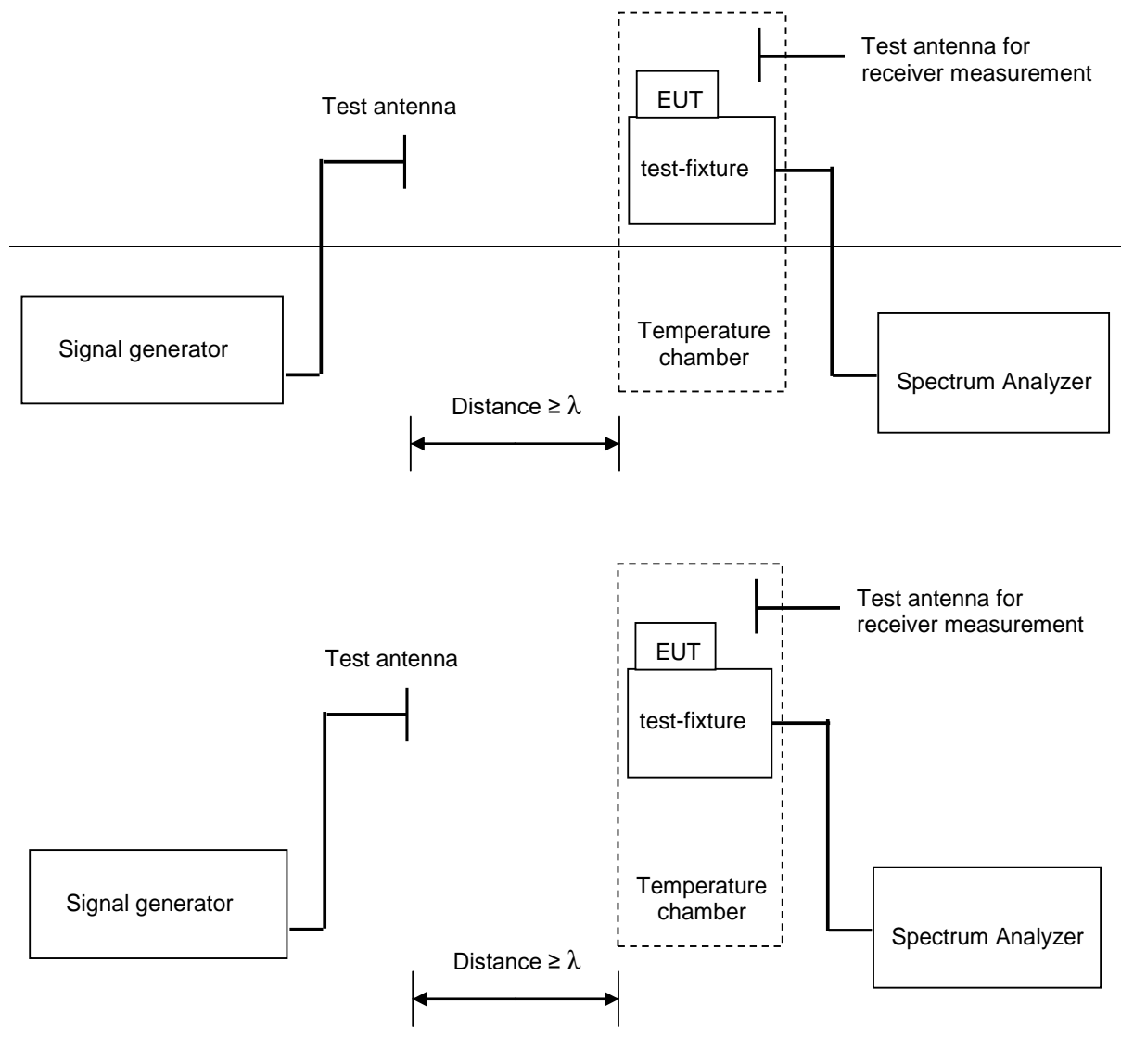

Figure 6: Validation of test set-up with EUT in place

Step 3:

In case of a battery operated EUT that is supplied by a temporary voltage feed as well as temporary signal- and control line, a decoupling filter shall be installed directly at the EUT in order to avoid parasitic, electromagnetic radiation (see figure 7).

In this step the signal generator and the transmit antenna are removed.

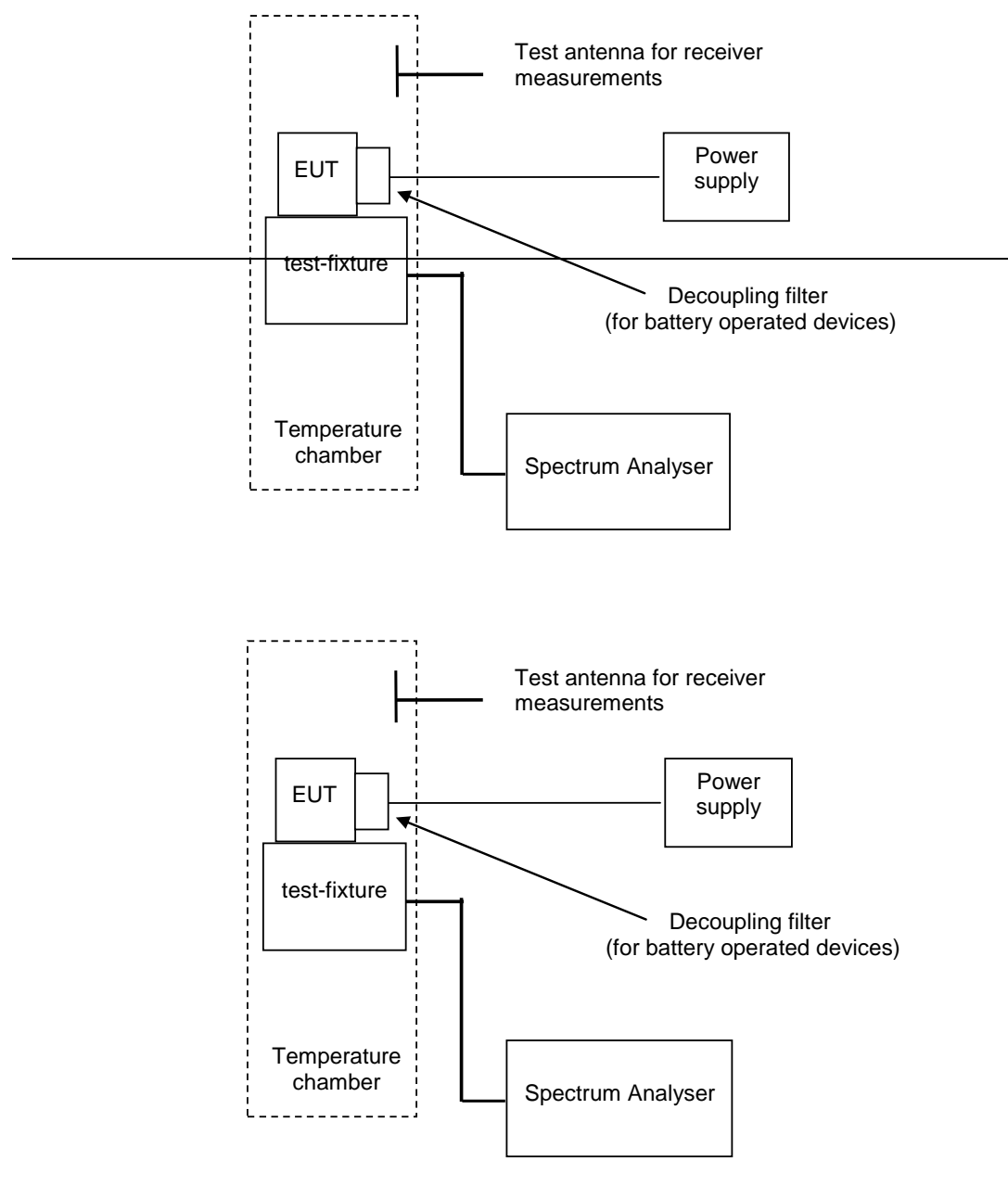

Figure 7: Test of EUT

5.8.3.2 Mode of use

The test fixture may be used to facilitate some of the transmitter and receiver measurements in the case of equipment having an integral antenna.

It is used particularly for the measurement of the radiated carrier power and usable sensitivity expressed as a field strength under extreme conditions. The test fixture shall only be used for relative power measurements or for measurements not dependent on coupling ratio. The measurements under extreme conditions are preceded by calibrated measurements according to ~~annex B~~ Annex E.

5.8.4 Test sites and general arrangements for radiated measurements

For guidance on radiation test sites, see ~~annex B~~ Annex E. Detailed descriptions of radiated measurement arrangements are included in this annex.

5.8.5 Measuring receiver

The term "measuring receiver" refers to a frequency-selective voltmeter or a spectrum analyser. An RMS detector is used if not defined otherwise for a specific measurement. The measurement bandwidth of the measuring receiver shall, where possible, be according to CISPR 16 [4], [2] and [3]. In order to obtain the required sensitivity, a narrower measurement bandwidth may be necessary, and in such cases, this shall be stated in the test report form. ~~The~~ Preferably ~~the~~ bandwidth of the measuring receiver shall be as given in table 98.

Table 98: Preferred bandwidth measurement

Frequency range: (f)	Measuring receiver Receiver reference bandwidth BWref
30 MHz ≤ f ≤ 1 000 MHz	100 kHz to 120 kHz
f > 1 000 MHz	1 MHz

In case a narrower measurement bandwidth was used, the following conversion formula has to be applied:

$$B = A + 10 \log \frac{BW_{ref}}{BW_{MEASURED}}$$

$$B = A + 10 \log \frac{BW_{ref}}{BW_{MEASURED}}$$

Where:

- A is the value at the narrower measurement bandwidth;
- B is the value referred to the reference bandwidth; or
- –use the measured value, A, directly if the measured spectrum is a discrete spectral line. (A discrete spectrum line is defined as a narrow peak with a level of at least 6 dB above the average level inside the measurement bandwidth.)

5.9 Interpretation of the measurement results

5.9.0 General

The interpretation of the results recorded in a test report for the measurements described in the present document shall be as follows:

- the measured value related to the corresponding limit will be used to decide whether an equipment meets the requirements of the present document;
- the value of the measurement uncertainty for the measurement of each parameter shall be included in the test report;
- the recorded value of the measurement uncertainty shall be, for each measurement, equal to or less than the figures in table 49.

For the test methods, according to the present document, the measurement uncertainty figures shall be calculated and shall correspond to an expansion factor (coverage factor) $k = 1,96$ or $k = 2$ (which provide confidence levels of respectively 95 % and 95,45 % in the case where the distributions characterizing the actual measurement uncertainties are normal (Gaussian)). Principles for the calculation of measurement uncertainty are contained in ETSI TR 100 028 [i.4], in particular in ~~annex D~~ Annex F of the ETSI TR 100 028-2 [i.4].

Table ~~409~~ is based on such expansion factors.

Table 409: Maximum measurement uncertainty

Parameters	Uncertainty
Radio frequency	$\pm 1 \times 10^{-7}$
RF power (conducted)	$\pm 2,5$ dB
Radiated emission of transmitter, valid to 26,5 GHz	± 6 dB
Radiated emission of transmitter, valid between 26,5 GHz and 66 GHz	± 8 dB
Radiated emission of receiver, valid to 26,5 GHz	± 6 dB
Radiated emission of receiver, valid between 26,5 GHz and 66 GHz	± 8 dB
Temperature	± 1 °C
Humidity	± 5 %
Voltage (\overline{DC}_{dc})	± 1 %
Voltage (\overline{AC}_{ac} , < 10 kHz)	± 2 %
NOTE: For radiated emissions above 26,5 GHz it may not be possible to achieve measurement uncertainties complying with the levels specified in this table. In these cases alone it is acceptable to employ the alternative interpretation procedure specified in clause 5.9.1.	

The particular expansion factor used for the evaluation of the measurement uncertainty shall be stated.

5.9.1 Measurement uncertainty is greater than maximum acceptable uncertainty

An interpretation of measurement results in accordance with this clause is only acceptable for radiated emissions above 26,5 GHz in the case where it is not possible to achieve measurement uncertainties complying with the levels specified in table 409. In these cases alone it is acceptable to employ the alternative interpretation procedure specified in clause 5.9.1.

The interpretation of the results when comparing measurement values with specification limits should be as follows:

- When the measured value plus the difference between the maximum acceptable measurement uncertainty and the measurement uncertainty calculated by the test technician does not exceed the limit value the equipment under test meets the requirements of the present document.
- When the measured value plus the difference between the maximum acceptable measurement uncertainty and the measurement uncertainty calculated by the test technician exceeds the limit value the equipment under test does not meet the requirements of the present document.
- The measurement uncertainty calculated by the test technician carrying out the measurement shall be recorded in the test report.
- The measurement uncertainty calculated by the test technician may be a maximum value for a range of values of measurement, or may be the measurement uncertainty for the specific measurement undertaken. The method used shall be recorded in the test report.

Annex A (informative): Relationship between the present document and the essential requirements of Directive 2014/53/EU

The present document has been prepared under the Commission's standardisation request C(2015) 5376 final [i.6] to provide one voluntary means of conforming to the essential requirements of Directive 2014/53/EU on the harmonisation of the laws of the Member States relating to the making available on the market of radio equipment and repealing Directive 1999/5/EC [i.1].

Once the present document is cited in the Official Journal of the European Union under that Directive, compliance with the normative clauses of the present document given in table A.1 confers, within the limits of the scope of the present document, a presumption of conformity with the corresponding essential requirements of that Directive and associated EFTA regulations.

Table A.1: Relationship between the present document and the essential requirements of Directive 2014/53/EU

Harmonised Standard ETSI EN 300 440					
Requirement				Requirement Conditionality	
No	Description	Essential requirements of Directive	Reference: Clause- No (s) of the present document	U/C	Condition
1	e.i.r.p.	3.2	4.2.2	C	Applies to all devices with transmitters
2	Permitted range of operating frequencies	3.2	4.2.3	C	Applies to all devices with transmitters
3	Unwanted emissions in the spurious domain	3.2	4.2.4	C	Applies to all devices with transmitters
4	Duty Cycle	3.2	4.2.5.4	C	Transmitting devices which do not use LBT, DAA, or RFID transmitters operating in the 2 446 to 2 454 MHz band transmitting more than 500 mW e.i.r.p. power level
5	Additional requirements for FHSS equipment	3.2	4.2.6	C	Equipment utilizing FHSS modulation
6	Adjacent channel selectivity	3.2	4.3.3	C	Applies to equipment Category 1 receivers
7	Blocking or desensitization	3.2	4.3.4	C	Applies to category 1, 2, and 23 SRD communication media receivers
8	Spurious radiation	3.2	4.3.5	C	Applies to all receivers, except receivers used in combination with permanently co-located transmitters continuously transmitting
9	Spectrum access techniques	3.2	4.4	C	Equipment which are not using duty cycle restrictions for media access
10	GBSAR antenna pattern	3.2	4.6.4	C	Applies only GBSAR systems
11	Limits for GBSAR	3.2	Annex F1	C	Applies only GBSAR systems

Key to columns:

Requirement:

No A unique identifier for one row of the table which may be used to identify a requirement.

Description A textual reference to the requirement.

Essential requirements of Directive

_____ Identification of article(s) defining the requirement in the Directive.

Clause-Number(s) of the present document

_____ Identification of clause(s) defining the requirement in the present document unless another document is referenced explicitly.

Requirement Conditionality:

U/C	Indicates whether the requirement is unconditionally applicable (U) or is conditional upon the manufacturer's claimed functionality of the equipment (C).
Condition	Explains the conditions when the requirement is or is not applicable for a requirement which is classified "conditional".

Presumption of conformity stays valid only as long as a reference to the present document is maintained in the list published in the Official Journal of the European Union. Users of the present document should consult frequently the latest list published in the Official Journal of the European Union.

Other Union legislation may be applicable to the product(s) falling within the scope of the present document.

Annex B (normative): EU wide harmonised national radio interfaces from 1 GHz to 40 GHz

Table B.1 summarizes the harmonised frequency bands and their technical key parameters for non specific short-range devices from EC Decision 2017/1483/EU [6].

Table B.1: EU wide harmonised national radio interfaces from 1 GHz to 40 GHz according to EC Decision (EU) 2017/1483 [6]

<u>Operational Frequency Band</u>	<u>Category of short-range devices</u>	<u>Transmit power limit/field strength limit/power density limit</u>	<u>Additional parameters (channelling and/or channel access and occupation rules)</u>	<u>Other usage restrictions</u>	<u>Band number from EC Decision 2013/752/EU [i.5]</u>	<u>Class 1 sub-class number according Commission Decision 2000/299/EU [i.9]</u>
A 2 400 - 2 483,5 MHz	Non-specific short-range devices	10 mW equivalent isotropic radiated power (e.i.r.p.)			57a	21
B 2 400 - 2 483,5 MHz	Radiodetermination devices	25 mW e.i.r.p.			57b	26
C 2 446 - 2 454 MHz	Radio Frequency Identification (RFID) devices	500 mW e.i.r.p.	Techniques to access spectrum and mitigate interference that provide at least equivalent performance to the techniques described in the present document must be used.		58	100
D 5 725 - 5 875 MHz	Non-specific short-range devices	25 mW e.i.r.p.			61	43
E 17,1 - 17,3 GHz	Radiodetermination devices	26 dBm e.i.r.p.	Techniques to access spectrum and mitigate interference that provide at least equivalent performance to the techniques described in harmonised standards adopted under Directive 1999/5/EC must be used.	This set of usage conditions is only available to ground-based systems.	65	88

Annex C (informative): National Radio Interfaces not EU wide harmonised

In addition to EU wide harmonised radio interfaces listed in Annex B, nations may implement NRIs with associated technical requirements to ensure spectrum compatibility. Usually these requirements come from CEPT/ERC/REC 70-03 [i.2] which sets out the general position on spectrum designations for Short Range Devices (SRDs) for countries within the CEPT. It is also used as a reference document by the CEPT member countries when preparing their national regulations in order to keep in line with the provisions of the Radio Equipment Directive. Appendix 1 in CEPT/ERC/REC 70-03 [i.2] provides an indicative overview of the implementation status in European countries.

Table C.1 provides an indicative list of these NRIs which might be available in some EU countries. Manufacturers are advised to check the most recently published version of any given NRI.

Table C.1: National Radio Interfaces not EU wide harmonised from 1 GHz to 40 GHz derived from CEPT/ERC/REC 70-03 [i.2]

<u>Operational Frequency Band</u>	<u>Maximum Power</u>	<u>Applications</u>	<u>Spectrum access and mitigation requirements</u>	<u>Modulation / maximum occupied bandwidth</u>	<u>Notes</u>	<u>CEPT/ERC/REC 70-03 Annex Number [i.2]</u>	<u>CEPT/ERC/REC 70-03 Frequency band [i.2]</u>
2 446 - 2 454 MHz	> 500 mW to 4 W <u>e.i.r.p.</u>	RFID	≤ 15 % duty cycle FHSS techniques should be used	Not specified	Power levels above 500 mW are restricted to be used inside the boundaries of a building and the duty cycle of all transmissions shall in this case be ≤ 15 % in any 200 ms period (30 ms on/170 ms off)	<u>11</u>	<u>c2</u>
9 200 - 9 500 MHz	25 mW <u>e.i.r.p.</u>	<u>Radiodetermination</u>	<u>No requirement</u>	<u>Not specified</u>		<u>6</u>	<u>h</u>
9 500 - 9 975 MHz	25 mW <u>e.i.r.p.</u>	<u>Radiodetermination</u>	<u>No requirement</u>	<u>Not specified</u>		<u>6</u>	<u>i</u>
10,5 - 10,6 GHz	500 mW <u>e.i.r.p.</u>	<u>Radiodetermination</u>	<u>No requirement</u>	<u>Not specified</u>		<u>6</u>	<u>i</u>
13,4 - 14 GHz	25 mW <u>e.i.r.p.</u>	<u>Radiodetermination</u>	<u>No requirement</u>	<u>Not specified</u>		<u>6</u>	<u>k</u>
24 - 24,25 GHz	100 mW <u>e.i.r.p.</u>	<u>Non-specific short range devices</u>	<u>No requirement</u>	<u>Not specified</u>	The frequency band is also identified in Annex 6 of CEPT/ERC/REC 70-03 [i.2]	<u>1</u>	<u>m</u>
24,05 - 24,25 GHz	100 mW <u>e.i.r.p.</u>	<u>Radiodetermination</u>	<u>No requirement</u>	<u>Not specified</u>	The frequency band 24,0 -24,25 GHz is identified with the same emission parameters in Annex 1 band m of CEPT/ERC/REC 70-03 [i.2]	<u>6</u>	<u>m</u>

Annex D (informative): Selection of technical parameters

D.1 Introduction

ETSI EG 203 336 [i.10] lists candidate technical parameters to be included in a Harmonised Standard aimed at providing a presumption of conformity of radio equipment with the essential requirements in articles 3.1(b) and 3.2 of the Radio Equipment Directive 2014/53/EU [i.6].

Essential requirements are high level objectives described in European Directives. The purpose of the Harmonised Standard is to translate those high level objectives into detailed technical specifications.

This annex provides information regarding selected parameters that may be in or not in the present document.

D.2 Receiver parameters

Adjacent channel selectivity is specified in the present document and applicable to category 1 receivers which require highly reliable SRD communication media; e.g. serving human life inherent systems (may result in a physical risk to a person).

Adjacent channel selectivity (ACS) is not a required receiver parameter for all categories. It has no effect on devices that use duty cycle as a mitigation technique.

Additionally, it has no effect on efficient use of spectrum by possible victim devices if LBT or DAA is utilized. If a device with LBT has poor ACS performance then LBT may be falsely triggered causing that device to withhold transmitting. However, that does not have a negative impact on spectrum efficiency, it only has a negative impact on the performance of that specific piece equipment. Product performance is not within the required domain of a regulator.

It has also to be noted that non specific SRDs and radiodetermination devices covered by this EN are not operating in channelized bands.

Receiver Blocking or desensification applies to all Equipment Category 1 and Category 2 receivers, and category 3 non-specific short range device receivers, when invoked, as defined in clause 4.3.1 in order to provide spectrum efficiency.

Receiver saturation is not specified in the present document as it does not affect spectrum efficiency.

Spurious emissions of receivers is specified for all equipment in the present document as it can effect spectrum efficiency.

Many receiver requirements fall under the general heading of linearity and these are covered in the present document by requirements on blocking performance.

Intermodulation performance is not specified in order to simplify testing. The risk of failure due to second order intermodulation products is considered low because the blocking specification leads to the ability to handle strong out-of-band signals. Manufacturers should assess the risk of intermodulation products when operating adjacent to high occupancy bands.

Annex E (normative): Radiated measurements

BE.1 General requirements for measurements involving the use of radiated fields

Measurements involving radiated fields require a prepared test site, well-characterized antenna equipment, calibrated test instrumentation, appropriate ancillary equipment such as cabling and filters, and appropriate test plans and methods. This annex provides minimum requirements and examples of suitable practice.

Test sites shall be suitable for radiated measurements and shall be designed to eliminate significant effects of objects or materials capable of influencing the interaction between test sample or substitute antenna and test antenna and instrumentation.

Test sites may consist of:

- Outdoor test sites.
- Indoor sites.
- Anechoic test sites.

The nature of the test site, precautions taken and evidence of suitability shall be recorded with the results of the tests.

Principal items of equipment are:

- Equipment under test with associated cabling.
- Antennas:
 - Test antenna.
 - Substitution antenna.
 - Artificial antenna.
- Test equipment:
 - Calibrated measuring receiver, spectrum analyser or other appropriate receiving instrument.
 - Calibrated filtering equipment.
 - Calibrated recording equipment.

The provisions below describe minimum acceptable standards for test sites, test methods and equipment and scope of testing.

The provisions below are appropriate for measurements in the far-field. Test result shall record where the near-field conditions are entered and the additional measurement uncertainty shall be evaluated, recorded and added to the test result, see clause BE.5.

BE.2 Test Sites

BE.2.1 Outdoor test site

An outdoor test site, see figure BE.1, shall provide:

- Measured support positions at least 3 m or $\lambda/2$ (at the test frequency) apart for the test item or substitution antenna and the test antenna, and a measured midpoint.

- A clear area greater than a circle of diameter twice the separation of the test item or substitution antenna from the test antenna, centred at the midpoint.
- Substantially level ground surface treated to render its effect either negligible (treatment to minimize reflection) or deterministic (treatment with flat reflecting material) and including the whole of the clear area.
- Sufficient precautions to ensure that reflections from extraneous objects beyond the clear area and within or adjacent to the site do not degrade the measurement results in accordance with CISPR 16 [4-1], [2] and [3].
- Non-conducting supports for the test item or substitution antenna and the test antenna.
- Provision for free-mounting equipment under test to be supported 1,5 m above the ground and rotated through 360° in the horizontal plane.
- Provision for floor-standing equipment to be mounted 100 mm above the ground and rotated through 360° in the horizontal plane.
- Provision for the test antenna to be moved between heights of at least 1 m to 4 m above the treated ground surface and rotated for operation in any plane of polarization.

Key:

- 1) equipment under test;
- 2) test antenna;
- 3) high pass filter (if necessary);
- 4) spectrum analyser or measuring receiver.

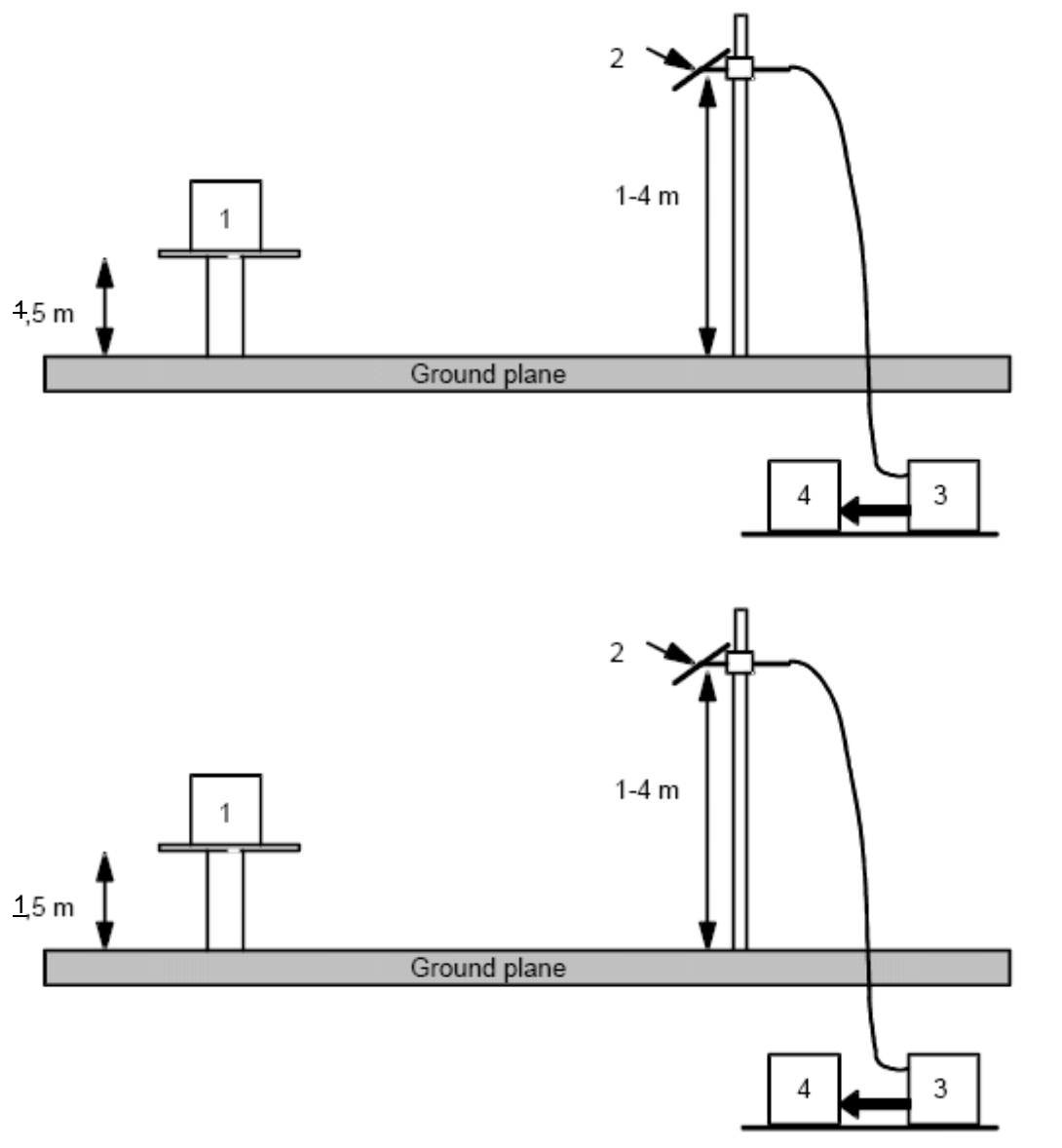

Figure BE.1: Outdoor test site

BE.2.2 Indoor test site

An indoor site may be used for test frequencies above 80 MHz. If an indoor site is used, this shall be recorded in the test report.

An indoor test site, see figure BE.2, shall provide:

- Floor, ceiling above 2,7 m, test sample wall and test antenna wall separated by at least 7 m and side walls separated by at least 6 m.
- A test antenna providing adequate sensitivity over the range of test frequencies and also providing adequate isolation from the effects of floor, ceiling, test antenna wall and side walls.

EXAMPLE: A corner reflector antenna.

- A test sample wall treated with anechoic material to render its effect negligible.
- Non-conducting supports for the test item or substitution antenna and the test antenna.

- Measured support positions on the long axis of the site and at least 3 m apart for the test item or substitution antenna and the test antenna.
- Sufficient precautions to ensure that the presence of objects within the room does not degrade the measurement results in accordance with CISPR 16 [41], [2] and [3].
- Provision for free-mounting test samples to be supported 1,5 m above the ground and rotated through 360° in the horizontal plane.
- Provision for floor-standing equipment to be mounted 100 mm above the ground and rotated through 360° in the horizontal plane.
- Provision for the test antenna to be centred at a height more than 1,35 m above the floor and more than 1,35 m below the ceiling, and to be rotated for operation in any plane of polarization.
- Provision for a substitution antenna to replace the equipment under test and to be moved up to $\pm 0,1$ m in any direction.

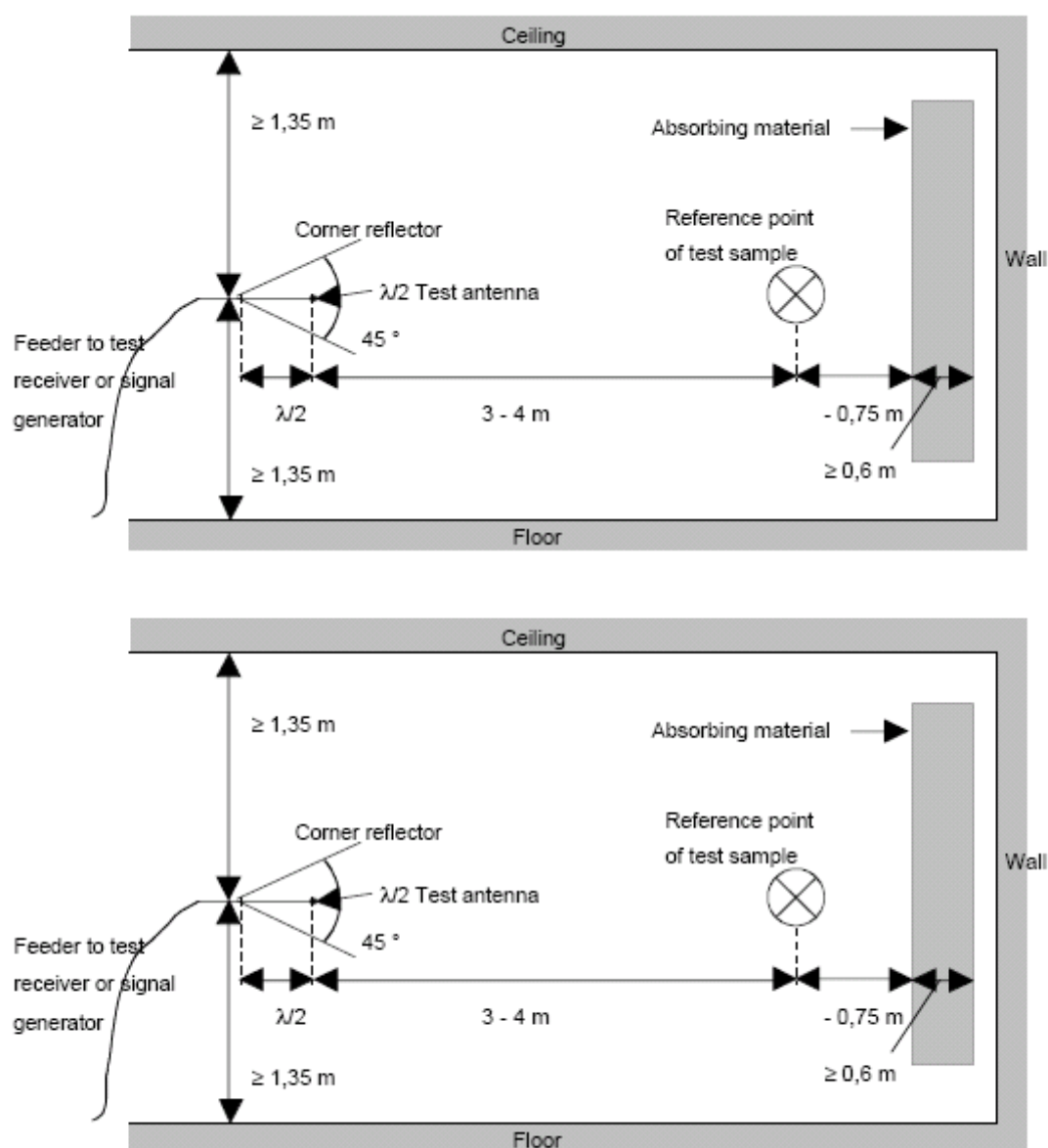

Figure BE.2: Indoor site arrangement (shown for horizontal polarization)

BE.2.3 Shielded anechoic test site

BE.2.3.0 General

"Anechoic" means that the walls, floor and ceiling of the enclosed test site are treated to substantially reduce radio reflections.

For radiation measurements under the present document a shielded, calibrated anechoic chamber may be used to simulate a free space environment. Such use shall be frequencies above 100 MHz unless specific treatment and calibration evidence at lower frequencies is provided. Calibration by a competent body shall confirm reflection attenuation at the walls to meet the limits provided in figure BE.3. Shielding better than the limits provided by figure BE.3 is desirable. An example of the construction of an anechoic chamber is shown in figure BE.4.

The chamber shall provide sufficient space to carry out tests as in the general method. If such a chamber is used, this shall be recorded in the test report.

The test antenna, measuring receiver, substitution antenna and calibrated signal generator are used in a way similar to that of the general method.

BE.2.3.1 Influence of parasitic reflections in anechoic chambers

With an anechoic chamber of the dimensions suggested in clause BE.2.3.0 at low frequencies up to 100 MHz far field conditions are not met and specific calibration procedures will be required. Careful attention is also required to the chamber calibration for frequencies above 1 GHz.

BE.2.3.2 Calibration of the shielded RF anechoic chamber

The chamber shall be calibrated over the range 30 MHz to 66 GHz.

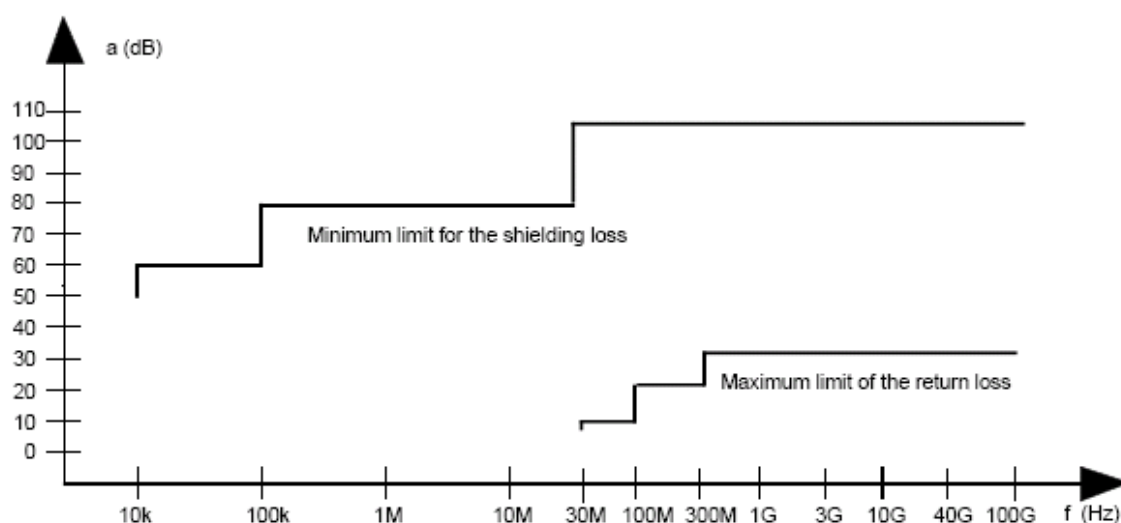

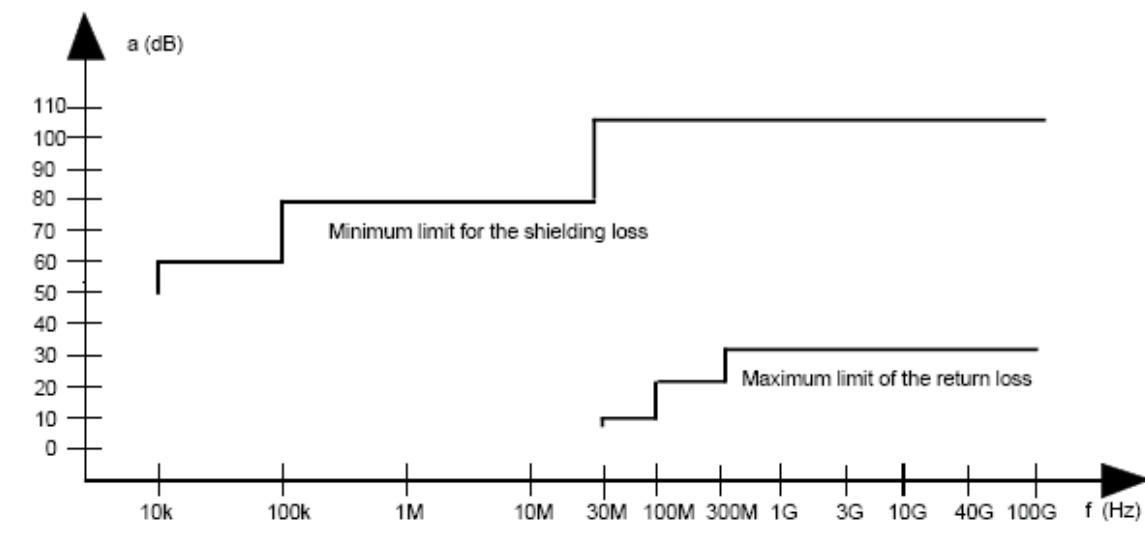
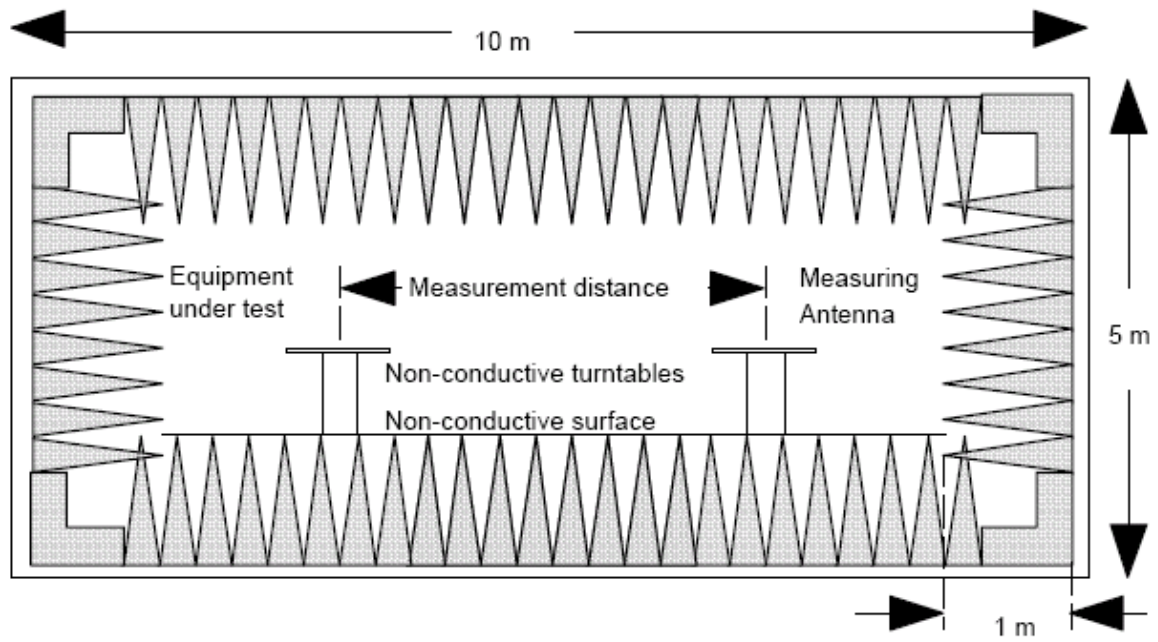
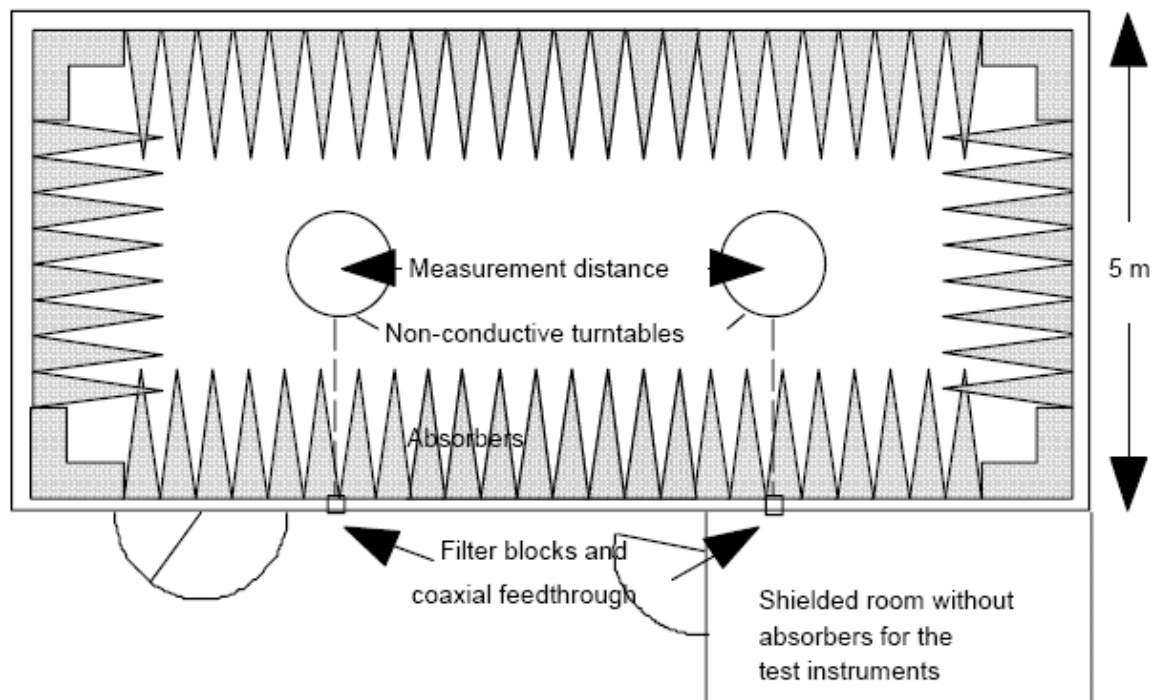

Figure BE.3: Specification for shielding and reflections



Ground plan



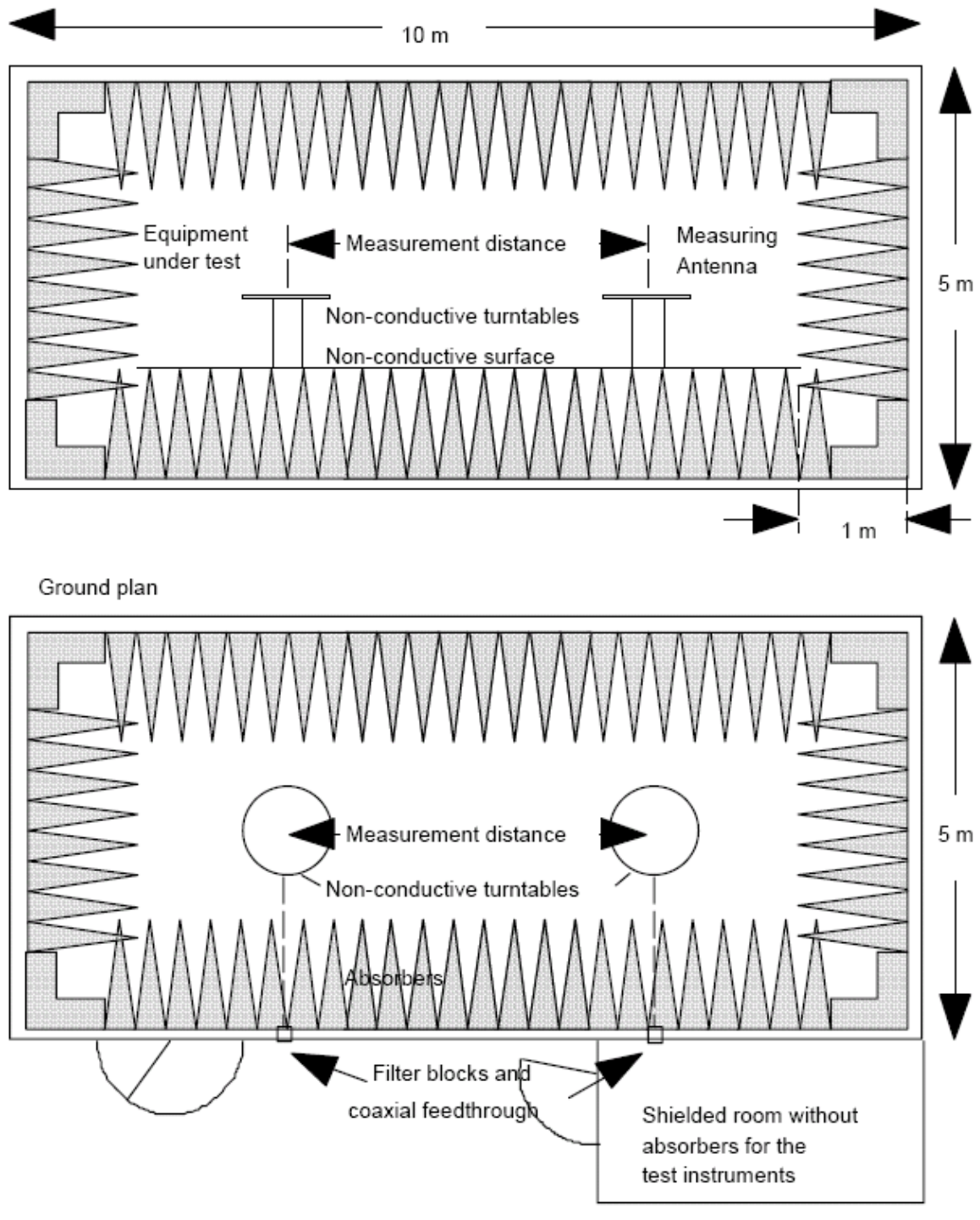

Figure BE.4: Example of construction of an anechoic shielded chamber

BE.3 Antennas

BE.3.1 Test antenna

The test antenna is used to detect the radiation from both the test sample and the substitution antenna for emission measurements. It is used as a transmitting antenna for the measurement of receiver characteristics.

The test antenna support provides for either horizontal or vertical polarization and for the height of its centre above ground to be varied over the range 1 m to 4 m or to the ceiling of an indoor or anechoic chamber, whichever is less. The test antenna shall provide boresight directivity equal to at least half the wall reflectivity limit prescribed in figure **BE.3**. The length of the test antenna along the measurement axis shall not exceed 20 % of the measuring distance.

For emission measurements, the test antenna is connected to a calibrated measuring receiver capable of being tuned to any frequency under investigation.

For receiver sensitivity measurements, the test antenna is connected to a calibrated signal generator capable of being tuned to any frequency under investigation.

Height variation shall be used to find the point at which the radiation is a maximum near the initial position.

BE.3.2 Substitution antenna

A substitution antenna may be used in place of the equipment under test when comparing equipment emissions with standard emissions.

When measuring in the frequency range up to 1 GHz the substitution antenna shall be a $\lambda/2$ dipole, resonant at the operating frequency, or a shortened dipole, calibrated to the $\lambda/2$ dipole. When measuring in the frequency range above 4 GHz, a horn radiator shall be used. For measurements between 1 GHz and 4 GHz either a $\lambda/2$ or a horn radiator may be used. The centre of this antenna shall coincide with the reference point of the test sample it has replaced. This reference point shall be the volume centre of the sample when its antenna is mounted internally, or the phase centre of an external antenna.

The distance between the lower extremity of the dipole and the ground shall not be less than 0,3 m.

The substitution antenna shall be connected to a calibrated signal generator when the site is used for spurious radiation measurements and transmitter effective radiated power measurements. The substitution antenna shall be connected to a calibrated measuring receiver when the site is used for the measurement of receiver sensitivity.

The signal generator and the receiver shall be connected to the antenna through suitable matching and balancing networks.

Where a shortened dipole antenna is used at these frequencies, details of the type of antenna used shall be included with the results of the tests and correction factors shall be taken into account.

The substitution antenna shall be moved through a distance of $\pm 0,1$ m in the direction of the test antenna as well as in the two directions perpendicular to this first direction to find the position of maximum response. If these changes of position cause a signal change of greater than 2 dB, the test sample should be re-sited and measurements repeated until a change of less than 2 dB with the substitution antenna is obtained.

BE.3.3 Artificial antenna

An artificial antenna may be connected to the equipment output port when cabinet or enclosure emissions are being tested and shall be substantially non-radiating.

Where possible, a direct connection should be used between the artificial antenna and the test sample. In cases where it is necessary to use a connecting cable, precautions should be taken to reduce the radiation from this cable by, for example, the use of ferrite cores or double screened cables.

BE.4 Test Practice and Auxiliary Test Equipment

Antenna characteristics and positions and test equipment settings shall be recorded with each test result.

Test equipment calibration shall be traceable to appropriate European standards. Test equipment, antenna and cable types or characteristics shall be recorded with the results of the tests.

Test methods shall comply with operator instructions for each item of equipment, with the measurements and limits described in the present document, and with the provisions and guidelines given below.

All test equipment shall be calibrated with traceability to European standards and used in accordance with the manufacturer's recommended operating procedures.

BE.5 Measuring distance

BE.5.0 General

Under the conditions provided in this annex, measurement frequencies will be above 25 MHz and the measuring distance should be greater than $2D^2/\lambda$ or $\lambda/2$, whichever is greater, at the frequency of measurement where D is the largest transmitting aperture dimension (far-field conditions). Outdoor sites will be required for low frequency measurements unless special provisions are made at an indoor, anechoic or near field site.

BE.5.1 Standard position

The standard position in all test sites, except for equipment which is intended to be worn on a person, shall be as follows:

- for equipment with an integral antenna, it shall be placed in the position closest to normal use as declared by the manufacturer;
- for equipment with a rigid external antenna, the antenna shall be vertical;
- for equipment with non-rigid external antenna, the antenna shall be supported by a non-conducting support at the initial height of the test antenna.

BE.5.2 Auxiliary cables

The position of auxiliary cables (power supply and microphone cables, etc.) which are not adequately de-coupled, may cause variations in the measurement results. In order to get reproducible results, cables and wires of auxiliaries should be arranged vertically downwards (through a hole in the non conducting support), or as specified in the technical documentation supplied with the equipment.

Care shall be taken to ensure that test cables do not adversely affect the measuring result.

Annex ~~CF~~ (normative): General description of measurement methods

~~CF~~.0 General

This annex gives the general methods of measurements for RF signals using the test sites and arrangements described in ~~annex B~~ Annex E. In addition, this annex gives a simple measurement method for radiated emissions based on a calculated rather than measured path loss.

~~CF~~.1 Conducted measurements

In view of the low power levels of the equipment to be tested under the present document, conducted measurements may be applied to equipment provided with an antenna connector. Where the equipment to be tested does not provide a suitable termination, a coupler or attenuator that does provide the correct termination value shall be used.

The equivalent isotropically radiated power is then calculated from the measured value, the known antenna gain, relative to an isotropic antenna, and if applicable, any losses due to cables and connectors in the measurement system.

~~CF~~.2 Radiated measurements

Radiated measurements shall be performed with the aid of a test antenna and measurement receiver as described in ~~annex B~~ Annex E. The test antenna and measurement receiver, spectrum analyser or selective voltmeter, shall be calibrated according to the procedure defined in this annex. The equipment to be measured and the test antenna shall be oriented to obtain the maximum emitted power level. This position shall be recorded in the measurement report. The frequency range shall be measured in this position.

Preferably, radiated measurements shall be performed in an anechoic chamber. For other test sites corrections may be needed (see ~~annex B~~ Annex E).

- a) ~~a)~~—A test site which fulfils the requirements of the specified frequency range of this measurement shall be used.
- b) ~~b)~~—The transmitter under test shall be placed on the support in its standard position (clause ~~BE~~.5.1) and switched on.
- c) ~~c)~~—The test antenna shall be oriented initially for vertical polarization unless otherwise stated. The test antenna shall be raised or lowered, through the specified height range until the maximum signal level is detected on the measuring receiver.

The test antenna need not be raised or lowered if the measurement is carried out on a test site according to clause ~~BE~~.3.

- d) ~~d)~~—The transmitter shall be rotated through 360° about a vertical axis to maximize the received signal.
- e) ~~e)~~—The test antenna shall be raised or lowered again, if necessary, through the specified height range until a maximum is obtained. This level shall be recorded.

(This maximum may be a lower value than the value obtainable at heights outside the specified limits).

- f) ~~f)~~—This measurement shall be repeated for horizontal polarization.
- g) ~~g)~~—The substitution antenna, shall replace the transmitter antenna in the same position and in vertical polarization. The frequency of the signal generator shall be adjusted to the transmitter (carrier) frequency.
- h) ~~h)~~—Steps c) to f) shall be repeated.
- i) ~~i)~~—The input signal to the substitution antenna shall be adjusted in level until an equal or a known related level to that detected from the transmitter is obtained in the test receiver.
- j) ~~j)~~—This measurement shall be repeated with horizontal polarization.

- k) ~~k)~~—The radiated power is equal to the power supplied by the signal generator, increased by the known relationship if necessary and after corrections due to the gain of the substitution antenna and the cable loss between the signal generator and the substitution antenna.

~~CF~~.3 Radiated measurement for receivers

Preferably, radiated measurements shall be performed in a FAR.

Measurements on receiving equipment are essentially the reverse of measurements on transmitters, with a signal generator connected to the measuring antenna. Calibration relies on the principle of replacing the EUT with a substitution antenna and suitable measuring equipment.

Clause ~~CF.2 Substitution~~ substitution antenna applies. (Note this does not require an actual half wave dipole, only an antenna with known gain relative to a half wave dipole.)

There are two methods:

- a) Connect the substitution antenna to a calibrated measuring receiver and read the measurement result directly.
- b) Measure the path loss from the measurement antenna to the substitution antenna and subtract this from the signal generator level to reach the measurement result.

For method a) the level received in some measurements is likely to be too low, so it may be necessary to raise the signal generator by a suitable amount and apply an equivalent offset to the measurement result.

Method b) means that one calibration measurement can be used for multiple tests.

Annex DG (normative): Power limits for RFID systems operating in the 2,45 GHz band

DG.1 Power limits and frequency band

DG.1.0 General requirements

The parameter limits for RFID equipment operating in the 2,45 GHz band are defined in table DG.1.

Table DG.1: Parameters for 2,45 GHz RFID systems

Frequency band	Power limit, e.i.r.p. (note 1)	Use of equipment	Comments
2 446 MHz to 2 454 MHz	+27 dBm	No restriction	FHSS or unmodulated carrier (CW) only
2 446 MHz to 2 454 MHz	+36 dBm (see note 2)	In-building only	FHSS only

NOTE 1: e.i.r.p. including an antenna with the following data:
a) equal or less than ± 45 degrees horizontal beamwidth;
b) equal or more than 15 dB sidelobe attenuation;
c) physical protection (e.g. antenna dome) which dimension limits a power transfer from the RFID antenna to a quarter wave matched dipole at positioned at an extreme close proximity to $\leq +15$ dBm.

NOTE 2: The use of power levels above +27 dBm (e.i.r.p.) shall by technical means be restricted to in building use only and shall have a duty cycle less than or equal to 15 % averaged over any 200 ms period (30 ms on/170 ms off).

DG.1.1 Additional requirements for 2,45 GHz 4 W e.i.r.p. indoor RFID equipment

Indoor 4 W e.i.r.p. RFID equipment shall be constructed with 2 power levels as described below:

- a) ~~a)~~—4 W e.i.r.p; and
- b) ~~b)~~—500 mW e.i.r.p.

The default power level is 500 mW e.i.r.p. or less.

The 4 W e.i.r.p. level is only enabled by a secure software code built into the equipment and which is only accessible by the manufacturer or his representative. The way in which the software code controls the power level shall be as below:

- 1) ~~1)~~—Fixed mounted 4 W RFID equipment shall be mounted inside a building and shall have a tamper proof function, which shall ensure self-destruction of the special software code if the RFID equipment is removed from its fixed mounting position. Such action shall reduce the power automatically to the default value of 500 mW e.i.r.p. or less.
- 2) ~~2)~~—Portable 4 W RFID equipment shall, via an inside building short range link, have a continuous update of the special software code. This code is generated by a fixed mounted control unit installed in the same indoor room or area in which the RFID equipment is to be used. Without a signal from this control unit, the RFID equipment shall reduce its power automatically to the default level of 500 mW e.i.r.p. or less. The control unit shall have a tamper proof function, which shall ensure self-destruction of the special software code if the unit is removed from its fixed, in building, mounting position.

Further information related to the above requirement is given in ~~annex E~~ Annex H.

DG.1.2 Spectrum mask

The spectrum mask shall be declared by the manufacturer and shall comply with the limits in table DG.2.

Table DG.2: Stair-case spectrum mask for RFID systems operating in the 2,45 GHz band

Frequency off-set, f ($f_0 = 2\,450$ MHz)	Limit	Measurement resolution Bandwidth
$f \leq f_0 - 4,20$ MHz and $f \geq f_0 + 4,20$ MHz	-5 dBm	30 kHz
$f \leq f_0 - 6,83$ MHz and $f \geq f_0 + 6,83$ MHz	-30 dBm	300 kHz
$f \leq f_0 - 7,53$ MHz and $f \geq f_0 + 7,53$ MHz	-30 dBm	1 MHz

Annex ~~E~~H (informative): Example of implementation for restriction of 4 W RFID to in-building use only

This annex provides guidance for RFID manufacturers to design an automatic inside/outside building power control, thus in order to meet the essential requirement as stated in the present document for radiated power levels of 2 W e.i.r.p. and 500 mW e.i.r.p. as relevant of the present document. Any other technical design may be implemented to achieve the same result.

The present annex describes an automatic inside/outside building power control scheme. A special, permanently fixed in-building mounted, System Control Unit (SCU) restricts the higher power of 4 W RFID to an operation inside a building only. In case the same RFID reader is moved outside the building or the RF beam is turned away from the in-building fixed installed SCU, e.g. towards windows or doors, then the power is automatically reduced to a default power level of 500 mW.

The SCU has a very short communication range (up to approximately 4 m) and transmits an access code to the RFID reader to obtain the higher power of 4 W. The RFID SCU is required to be installed at a permanent fixed position inside a building where the higher power (4 W) is needed.

The above-mentioned schemes will prevent an RFID reader to transmit the higher power when moved outside the range of the SCU. The result of such action is the reader loses its high power access code and consequently the power is automatically reduced to 500 mW. Furthermore, the user of the RFID system does not need to do anything special.

To enforce the use of 4 W inside a building only, the following design options are suggested for SCUs, either:

- a) ~~a)~~—SCU units are equipped with a tamper switch to prevent these units from being removed together with its high power access code from their fixed mounting position inside a building. Any tampering with these units causes permanent loss of the access code for the higher power level. This prevents the user from moving the SCU functionality to a position outside the building. It is further suggested that only a manufacturer's representative can obtain the necessary tools to generate new high power access code. Or
- b) ~~b)~~—SCUs are mounted by a special tool that is not for general sale. Or
- c) ~~c)~~—SCUs are designed to be installed once; if removed, they are permanently destroyed.

An example for 2,45 GHz RFID installation using this principle is shown in figure ~~E~~H.1.

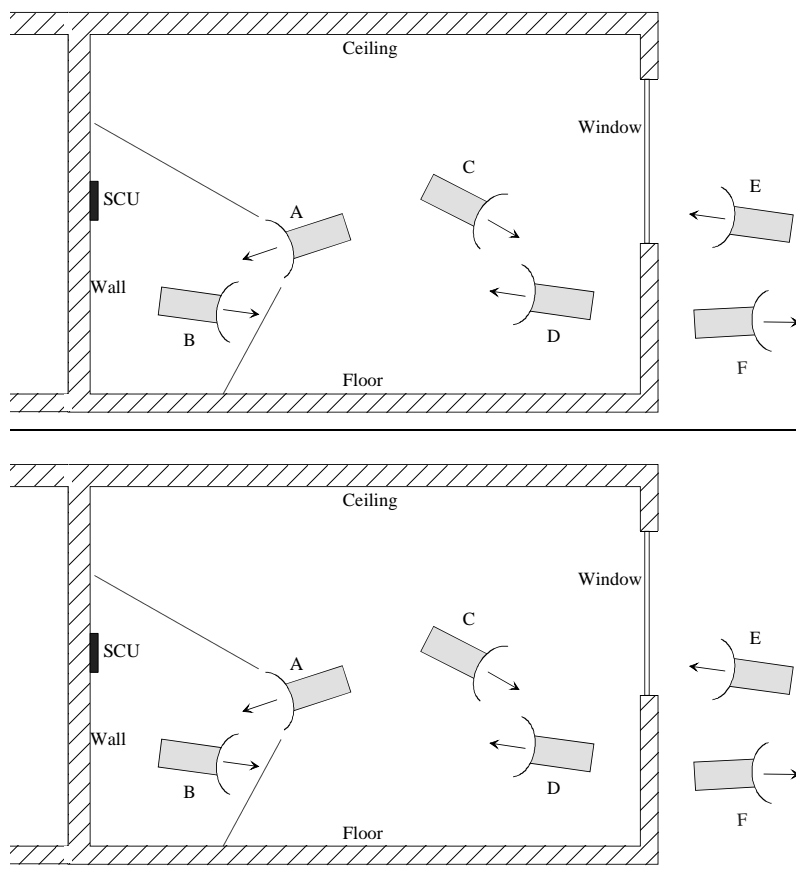

Figure EH.1: Example for RFID system with an automatic RF power control for in- and outside building operation

RFID readers, A to F in figure EH.1, are all of same type having both 4 W and 500 mW radiated power (e.i.r.p.) with a default power level of 500 mW. Only reader A is able to communicate with the System Control Unit (SCU) via its antenna main beam at close distance and is therefore allowed to radiate with the higher power of 4 W e.i.r.p. All other readers, B to F, are either out of range or outside the antenna main beam concerning the SCU and are therefore forced to radiate with the default power level of 500 mW e.i.r.p.

As an example, the SCU may be passive (without any transmitter) if control communication system is based on radio. In this case, the SCU is only re-modulating and reflecting reader transmitted signals like a normal RFID tag. As the reader receiver sensitivity is limited to approximately -62 dBm the SCU to reader range is limited to approximately 3 m and 5 m for reader radiated power of 500 mW and 4 W respectively. This will effectively limit the maximum distance between the reader and the SCU to approximately 3 m in order to turn-on the 4 W power level.

Annex F (normative): Limits for GBSAR operating in the frequency range 17,1 GHz to 17,3 GHz

F.1 Introduction

The present annex specifies limits for Ground Based Synthetic Aperture Radar (GBSAR) based Stepped Frequency CW (SF-CW) radar operating in the frequency range 17,1 GHz to 17,3 GHz.

GBSAR system is used for detection of movement and its scope is limited to radar equipment operated as a short range device. The GBSAR applications considered in the present document are intended exclusively for detection of movement related to structures potentially effecting the protection of workers and the general public. A few examples of applications are given below:

- static and dynamic load analyses of constructions like bridges and buildings;
- landslide monitoring;
- volcano and earthquake movement detection;
- urban area subsidence detection.

Method of measurements and other limits than given in clause F.2 are in accordance with the present document.

F.2 Effective radiated power (e.i.r.p.)

F.2.1 Definition

See clause 4.2.2.2.

F.2.2 Method of measurement

See clause 4.2.2.3.

F.2.3 Limits

The radiated power shall not exceed +26 dBm e.i.r.p.

F.3 Permitted range of operating frequencies

F.3.1 Definition

See clause 4.2.3.2.

F.3.2 Method of measurement

See clause 4.2.3.3.

F.3.3 Limits

The permitted range of operation is 17,1 GHz to 17,3 GHz.

4 Principles of Detection And Avoid (DAA)

4.0 General

In order to avoid any interference of GBSAR towards other radar systems operating in the same frequency range, a GBSAR equipment shall use a Detection And Avoid (DAA) spectrum access method.

Equivalent or better techniques than DAA may be used, providing that they are providing equivalent protection.

The principle of DAA is that GBSAR shall sense the channel within its operative bandwidth, in order to detect the possible presence of other radar systems. If a radar system is detected GBSAR shall avoid the transmission until the other radar system disappears.

The DAA threshold and timing requirements are defined in clauses 4.3 and 4.4 respectively.

4.1 DAA test set-up

The following DAA test set-up shall be used (see figure 1).

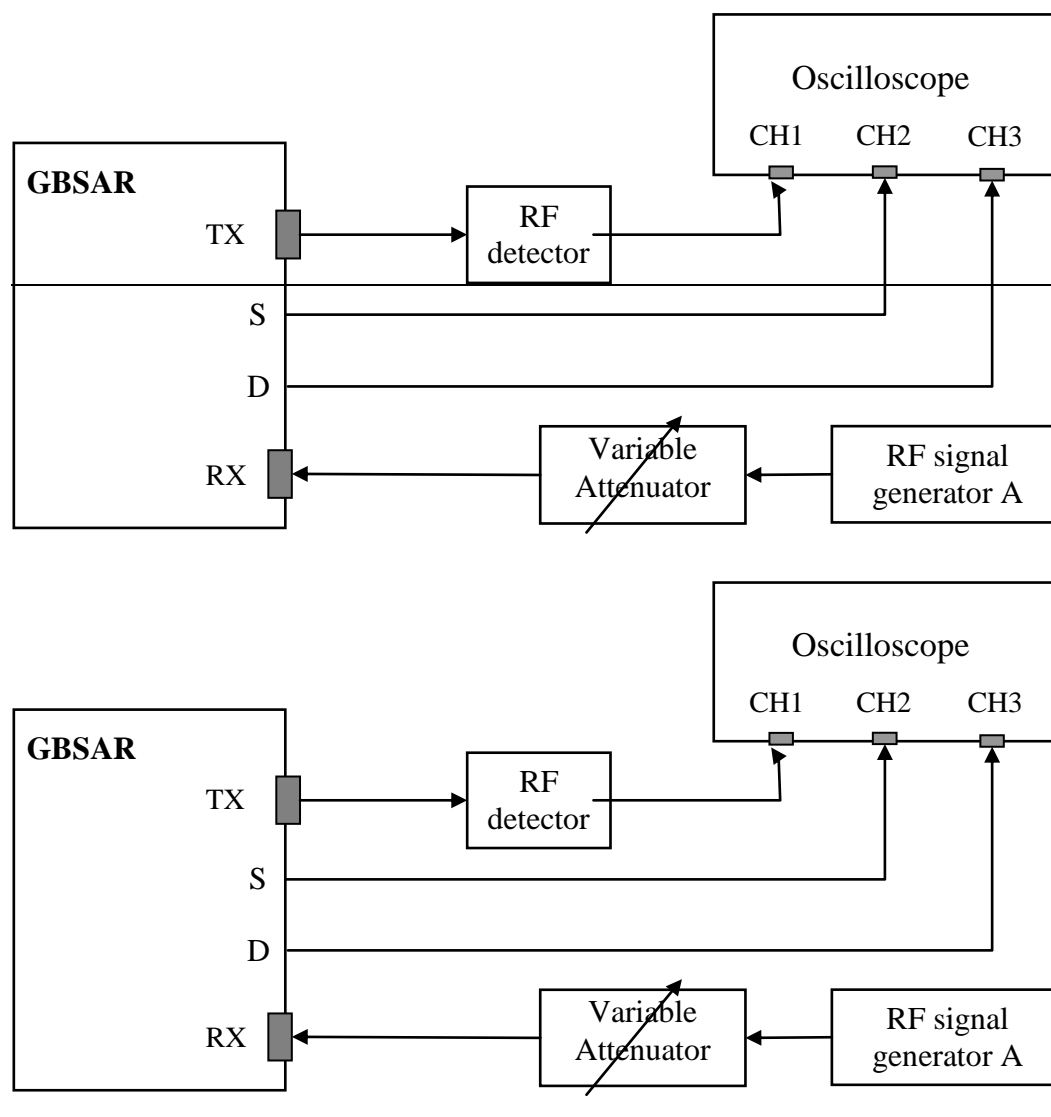

Figure 4.1: DAA measurement arrangement

The DAA test set-up is composed by:

- a) An RF signal generator, A, is connected to GBSAR receiver antenna connector via appropriate attenuator. A variable attenuator is used to vary the output power of signal generator A into to the GBSAR receiver.
- b) GBSAR transmitter antenna connector is connected to channel 1 of a three channel oscilloscope via an RF detector. The detected RF signal measured by the oscilloscope will show when GBSAR is actually transmitting.
- c) GBSAR shall provide an output logic test signal, S, indication when the intended operation command of GBSAR is started and stopped respectively. This signal is connected to channel 2 of the oscilloscope.
- d) GBSAR shall provide an output logic signal, D, indication when the level from the signal generator A is detected above and below the GBSAR receiver DAA threshold respectively. This signal shall be connected to channel 3 of the oscilloscope.

The signal generator A shall be able to generate all the test signals defined in clause F.4.2, table F.1.

The variable attenuator shall provide a range of at least 20 dB of attenuation in 1 dB steps.

For equipment with integral antennas the connection with GBSAR receiver and transmitter shall be made with a temporary antenna connector or an appropriate test fixture, (see clauses 4.2.3 and 5.8.3).

F.4.2 Test signals

For validation of the DAA function the necessary characteristics of four RF test signals and their related test modulation are defined in table F.1.

Table F.1: Characteristics of RF test signals for different types of radar systems

Parameter	Unit	Type 1	Type 2	Type 3	Type 4
Modulation		Linear FM pulse	Linear FM pulse	Frequency Hopping	Linear FM pulse
Frequency range	GHz	17,1 to 17,3	17,1 to 17,2	17,1 to 17,3	17,1 to 17,3
Chirp bandwidth	MHz	200	100	30	3
Signal generator	dBm/MHz	-71,0	-66	-35,0	-50,0
Peak Power	dBm	-48,0	-46	-20,2	-45,2
Pulsewidth	μs	15,3	40,6	0,1	17
PRR, Pulse repetition rate	pps	2 041	900	1 333	3 140

F.4.3 DAA threshold

F.4.3.1 Definition

The DAA threshold is defined as the received signal power level at GBSAR antenna connector above which the equipment shall determine the presence of a radar system.

Different DAA thresholds are defined according to the actual radar system signal characteristics, see clause F.4.2, table F.1.

F.4.3.2 Method of measurement

The test set-up in figure F.1 shall be used. The following procedure shall be used:

- a) a) —The attenuator is set at the minimum attenuation (ideally 0 dB).
- b) b) —A test signal according to clause F.4.2, table F.1 with a power level +10 dB above the DAA threshold limit is applied by the RF signal generator A.
- c) c) —The time, t_0 , at which the transmitter is intended to be switched-on shall be noted at the oscilloscope on channel 2 of the oscilloscope.
- d) d) —It shall be noted that a DAA level above its threshold is detected at channel 3 at the oscilloscope.
- e) e) —The RF power level from the RF generator A is reduced in 1 dB steps by the increasing the attenuation of attenuator until a signal is not anymore detected on channel 3 of the oscilloscope.

- f) ~~f)~~—The resulting RF power level at GBSAR ~~RXR~~ antenna connector is calculated as the difference between the signal generator power level in dBm minus the attenuator value in dB. The final level (the DAA threshold) is noted and recorded in the test report.

The procedure a) to f) shall be made for each type of the four test signals according the clause ~~F.4.2~~, table ~~F.1~~.

F.4.3.3 Limit

The maximum DAA threshold for GBSAR in listen mode is given in table ~~F.2~~.

Table ~~F.2~~: Maximum DAA thresholds

Test signal type	DAA maximum threshold
1	-81 dBm/MHz
2	-76 dBm/MHz
3	-45 dBm/MHz
4	-60 dBm/MHz

As an option a manufacturer may select to test only one DAA threshold, in this case the lowest limit value shall apply.

F.4.4 DAA timing parameters

F.4.4.1 Minimum listen Time

F.4.4.1.1 Definition

Prior to any GBSAR operation a minimum listen time applies. The minimum listen time, t_D , is defined as the minimum time that GBSAR listens within its bandwidth immediately prior any indented transmission to determine if one or more radar systems are transmitting within range. If a radar system is detected, then ~~clauses F.4.4.2 and F.4.4~~ ~~apply~~ ~~applies~~.

F.4.4.1.2 Method of measurement

The test set-up in figure ~~F.1~~ shall be used. The following test procedure shall be used:

- ~~a)~~—Set the attenuator at the maximum attenuation (at least 20 dB).
- ~~b)~~—A test signal according to clause ~~F.4.2~~, table ~~F.1~~ is applied by the RF signal generator A. The signal generator is switched on. The received power level at GBSAR ~~RXR~~ antenna connector shall be at least 10 dB below the DAA threshold limit, see clause ~~F.4.3.3~~, table ~~F.2~~.
- ~~c)~~—The GBSAR is intentionally switched on and the time, t_0 , is noted at channel 2 of the oscilloscope.
- ~~d)~~—The time, t_p , when the actual transmission is automatically switched-on is noted at channel 1 of the oscilloscope. The minimum listen time is calculated as: $t_D = t_t - t_0$.

The minimum listen time measured is illustrated at figure ~~F.2~~.

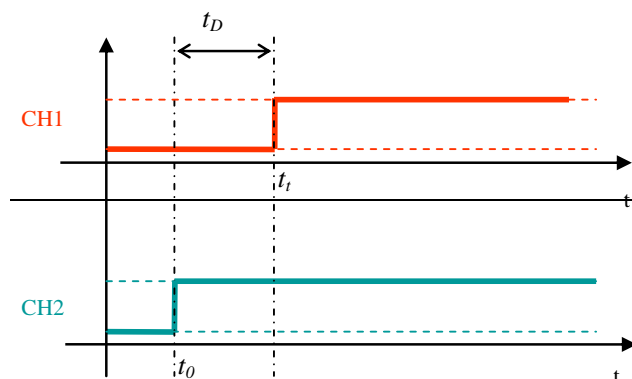

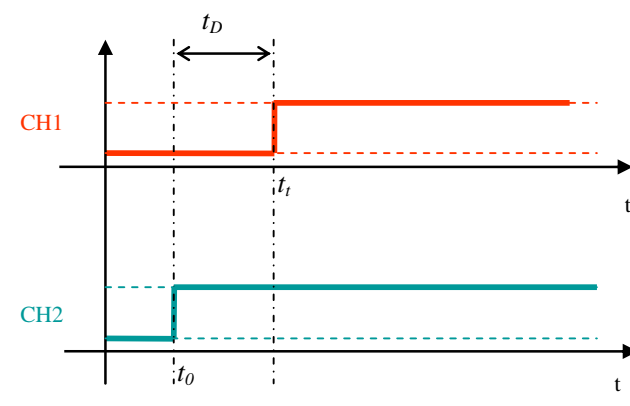

Figure F1.2: Minimum listen time, t_D , measurement

F1.4.4.1.3 Limit for minimum listen time

The limit for the minimum listen time t_D is > 15 s.

The value of t_D shall be noted in the test report by the equipment manufacturer.

F1.4.4.2 Minimum listen time after detection

F1.4.4.2.1 Definition

If a radar signal which is not generated by GBSAR is detected then GBSAR shall sense the channel for a time interval defined as minimum listen time after detection t_L , before starting or continuing any transmission. If during this interval a radar system is detected t_L is reset.

F1.4.4.2.2 Method of measurement

The test set-up in figure F1.1 shall be used. The following test procedure shall be used:

- a) a) —Set the attenuator at the minimum attenuation (ideally 0 dB).
- b) b) —A test signal according to clause F1.4.2, table F1.1 is applied by the RF signal generator A. The power level at GBSAR ~~RXR~~ antenna connector shall be at least 10 dB above the DAA threshold. (The DAA threshold is defined in clause F1.4.3.3, table F1.2).
- c) c) —The time, t_0 , at which the intended transmitter command is switch-on shall be noted at channel 2 of the oscilloscope, see figure F1.3.
- d) d) —Note that a DAA level above the DAA threshold is detected at channel 3 at the oscilloscope and that no transmission is present by monitoring channel 1 at the oscilloscope, see figure F1.3. These facts shall be noted in the test report.
- e) e) —By increasing the value of variable attenuator in steps of 1 dB, the power from the signal generator A to the GBSAR receiver antenna connector is reduced.
- f) f) —When the power from the signal generator A at ~~RXR~~ antenna connector is reduced to 3 dB below the DAA threshold, then the time, t_S , shall be noted, see figure F1.3. The value of the attenuation shall also be noted.
- g) g) —It shall be noted that a DAA level below the DAA threshold is detected at channel 3 at the oscilloscope.
- h) h) —Note the time, t_p , when the transmitter is automatically switched-on at channel 1 of the oscilloscope.

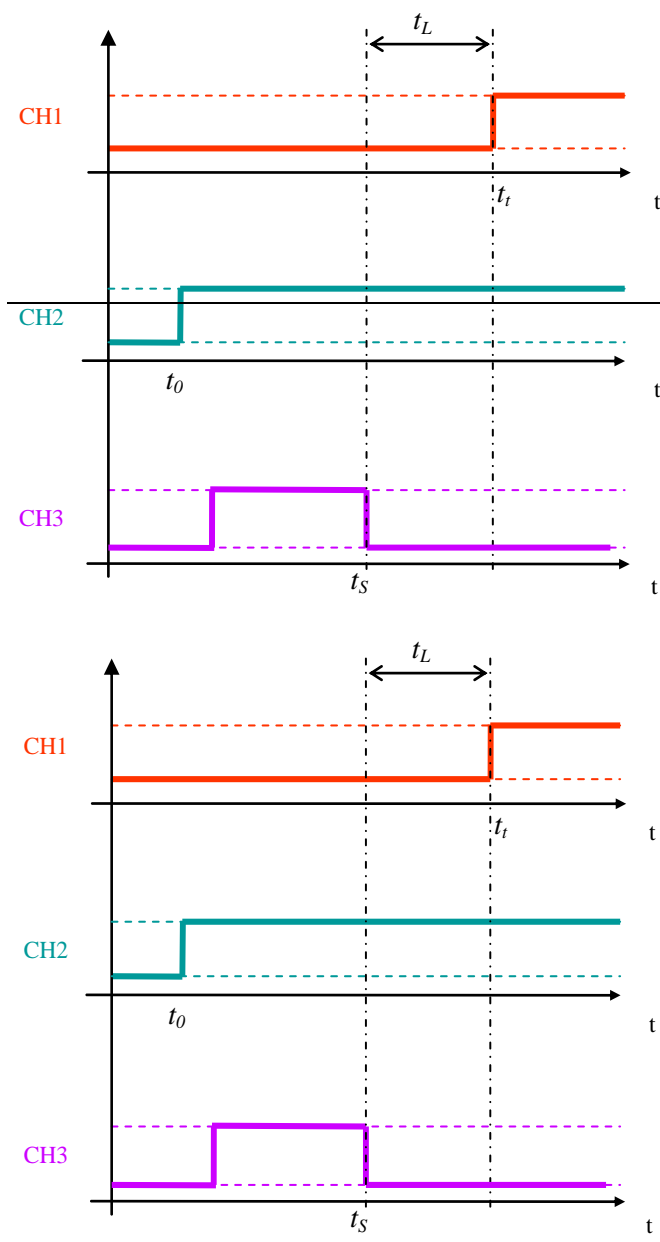

Figure F1.3: Minimum listen time after detection, t_L , measurement

F1.4.4.2.3 Limit

The minimum listen time after detection, t_L , is calculated as:

$$t_L = t_t - t_S$$

$$t_L = t_t - t_S$$

The limit for the minimum listen time after detection is $t_L > 120$ s.

The value of t_L shall be noted in the test report.

4.4.3 Maximum transmitter on-time

4.4.3.1 Definition

The maximum transmitter on-time, t_{on} , is defined as the maximum time GBSAR can transmit continuously without interruption.

GBSAR shall only be allowed to transmit continuously for a maximum specified period. This will prevent GBSAR to transmit for an extended time without noticing the presence of a radio location system.

4.4.3.2 Method of measurement

The test set-up in figure 4.1 shall be used. The following test procedure shall be used:

- a) a) —Set the attenuator at the maximum attenuation (at least 20 dB).
- b) b) —A test signal according to clause 4.2, table 4.1 is applied by the RF signal generator A and the generator is switched on. The received power level at GBSAR ~~RXX~~ antenna connector shall be at least 10 dB below the DAA threshold, see clause 4.3.3, table 4.2.
- c) e) —GBSAR is switched on, The time, t_0 , at the intended switch-on command shall be noted at channel 2 of the oscilloscope, see figure 4.
- d) d) —Note the time, t_r , when the transmitter is actually switched-on (channel 1 of the oscilloscope).
- e) e) —Note the time, t_e , when the transmitter is automatically switched-off at channel 1 of the oscilloscope.

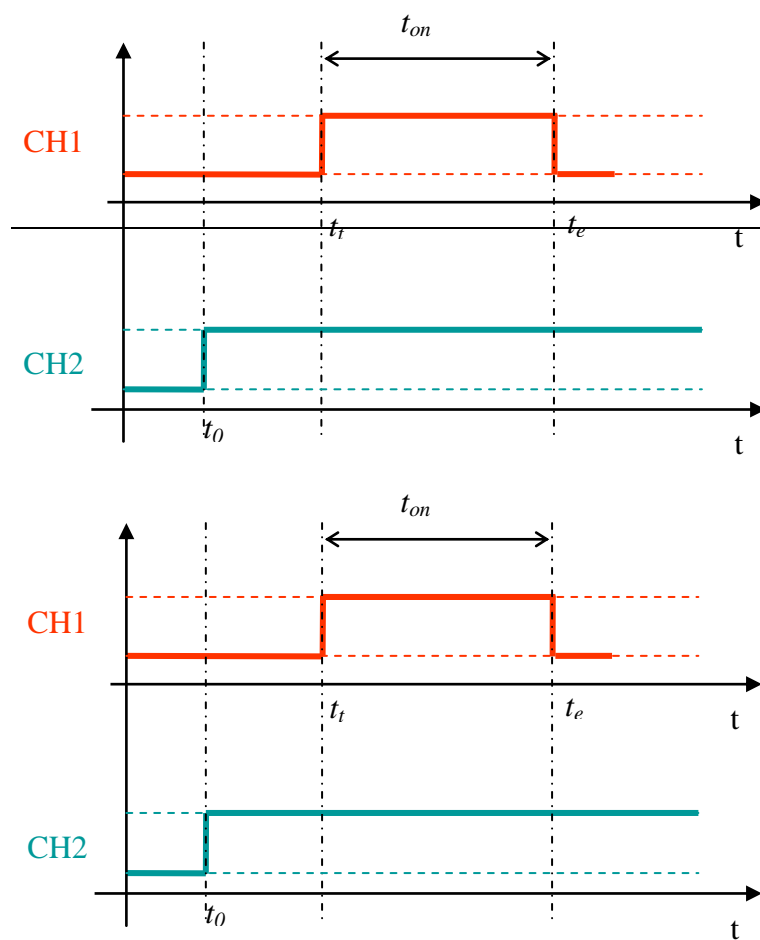

Figure 4: Maximum transmit on-time, t_{on} , measurement

F1.4.4.3.3 Limit

The maximum transmitter on-time, t_{on} , is calculated as:

$$t_{on} = t_e - t_t$$

The limit for maximum ~~TX~~-Tx on-time, t_{on} is < 40 s.

The value of t_{on} shall be noted in the test report.

F1.4.4.4 Minimum transmitter off-time

F1.4.4.4.1 Definition

The minimum ~~TX~~-Tx off-time, t_{off} , is defined as the period where GBSAR shall remain off after a transmission period. During ~~TX~~-Tx off-time GBSAR shall again sense the channel in order to detect the presence of a radar system.

If during t_{off} GBSAR detects the presence of a radar system then clause F1.4.4.2 applies.

F1.4.4.4.2 Method of measurement

The test set-up in figure F1.1 shall be used. The following test procedure shall be used:

- a) a) — Set the attenuator at the maximum attenuation (at least 20 dB).
- b) b) — A test signal according to clause F1.4.2, table F1.1 is applied by the RF signal generator A and the generator is switched on. The power level at GBSAR ~~RXR~~ antenna connector is at least 10 dB below the DAA threshold, see clause F1.4.3.3, table F1.2.
- c) c) — The time, t_0 , at the intended transmitter switch-on command shall be noted at channel 2 of the oscilloscope, see figure F1.5.
- d) d) — The time, t_p , when the transmitter is actually switched-on shall be noted at channel 1 of the oscilloscope, see figure F1.5.
- e) e) — Note the time, t_e , when the transmitter is automatically switched-off at channel 1 of the oscilloscope see figure F1.5.
- f) f) — Note the time, t_r , when the transmitter is automatically switched-on at channel 1 of the oscilloscope, see figure F1.5.

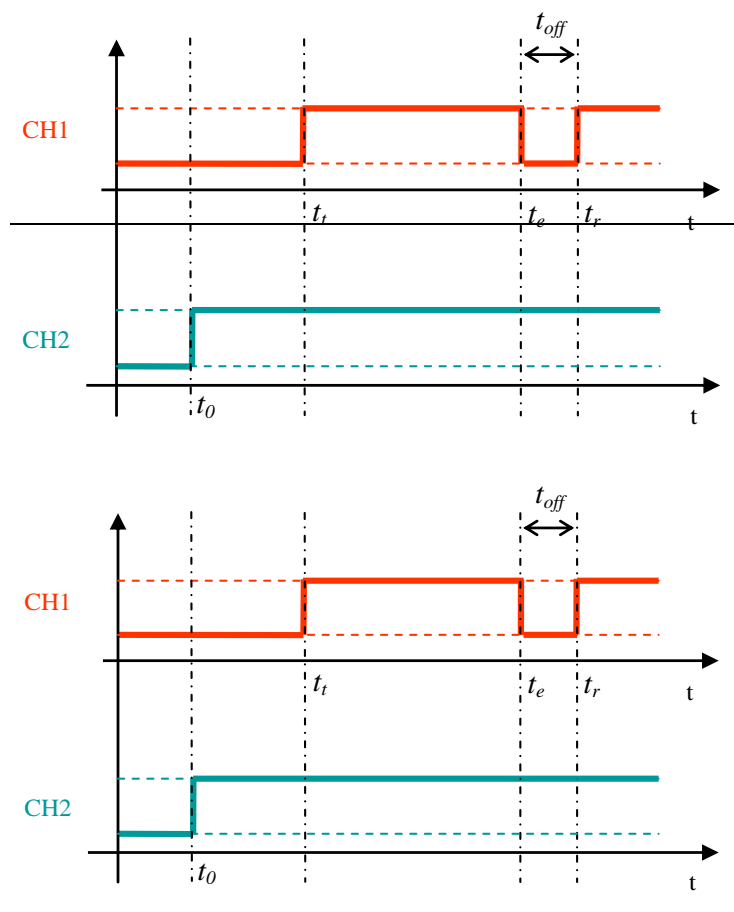

Figure F1.5: Maximum transmit off-time, t_{off} measurement

F1.4.4.4.3 Limit

The minimum ~~TX-Tx~~ off-time, t_{off} is calculated as:

$$t_{off} = t_r - t_e$$

The limit for minimum ~~TX-Tx~~ off-time t_{off} is ≥ 40 ms.

The value of t_{off} shall be noted in the test report.

F1.5 Antenna pattern

F1.5.1 Definition

The antenna pattern is defined as the antenna radiating efficiency in all directions relative to the antenna boresight.

F1.5.2 Method of measurements

The measurements shall be made in an anechoic chamber and the set-up in figure F1.6 shall be used.

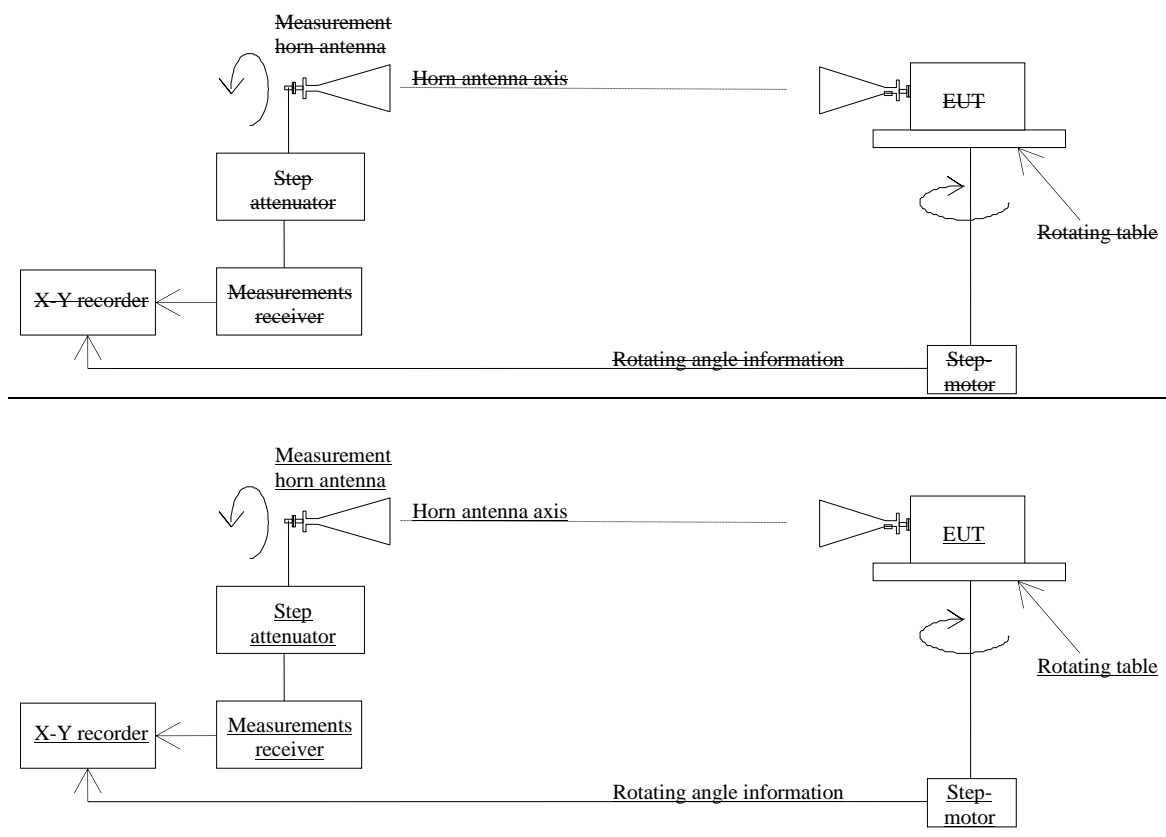

Figure F1.6: Test set-up for measurement of antenna pattern

The measurement antenna shall be a linear polarized horn with at least 20 dB gain. The antenna shall be able to be rotated around its radiating axis, see figure F1.6. The measurement antenna is connected to a measurements receiver or spectrum analyser.

The distance between the measurement antenna and the EUT shall be sufficient to ensure that the measurements are conducted in the far-field, for further details see clause B1.5.

The equipment under test (EUT) shall be placed on the rotating table to measure the horizontal antenna pattern, see figure F1.6.

The following steps shall be followed:

- a) The transmitter shall be switched-on.
- b) The measurement antenna shall be adjusted to same height as the antenna for the equipment under test (EUT).
- c) The measurement antenna shall be adjusted in the direction of the antenna for the equipment under test (EUT).
- d) The equipment antenna shall be adjusted in the direction of maximum reading at the measurement antenna. The direction on the rotating table is the reference direction (0 degrees on the rotating table).
- e) The measurement antenna is rotated around its axis for maximum reading at the measurements receiver. The reading is the reference reading (0 dB).
- f) The rotating table is rotated from -90 degrees via 0 degrees to +90 degrees and the corresponding readings on the measurement receiver shall be recorded. Any peaks reading of sidelobes shall specifically be recorded.
- g) The measurement antenna is rotated 90 degrees around its axis.
- h) The measurement point f) shall be repeated.
- i) The transmitter is switched-off.

- j) The equipment under test is mounted sideways on the rotating table (tilted by 90 degrees) to simulate measurements of vertical antenna elevation, see figure ~~F~~1.6.
- k) The transmitter shall be switched-on.
- l) The measurement antenna shall be adjusted to same height as the antenna for the equipment under test (EUT).
- m) The measurement antenna shall be adjusted in the direction of the antenna for the equipment under test (EUT).
- n) The equipment antenna shall be adjusted in the direction of maximum reading at the measurement antenna. The direction on the rotating table is the reference direction (0 degrees on the rotating table).
- o) The measurements antenna is rotated around its axis for maximum reading at the measurements receiver. The reference reading is the same as in d) above (0 dB).
- p) The rotating table is rotated from -90 degrees via 0 degrees to +90 degrees and the corresponding readings on the measurement receiver shall be recorded. Any peaks reading of sidelobes shall specifically be recorded.
- q) The measurement antenna is rotated 90 degrees around its axis.
- r) The measurement point p) shall be repeated.
- s) The transmitter is switched-off.

The above results in total four antenna pattern measurements. The measurements a) to i) cover the horizontal antenna pattern measurements. The measurements j) to s) cover the vertical antenna pattern. The results shall be noted in the test report.

5.3 Limits

The EUT antenna pattern measured in clause 5.2 shall not have less attenuation than the limit curves given in figures 7 and 8.

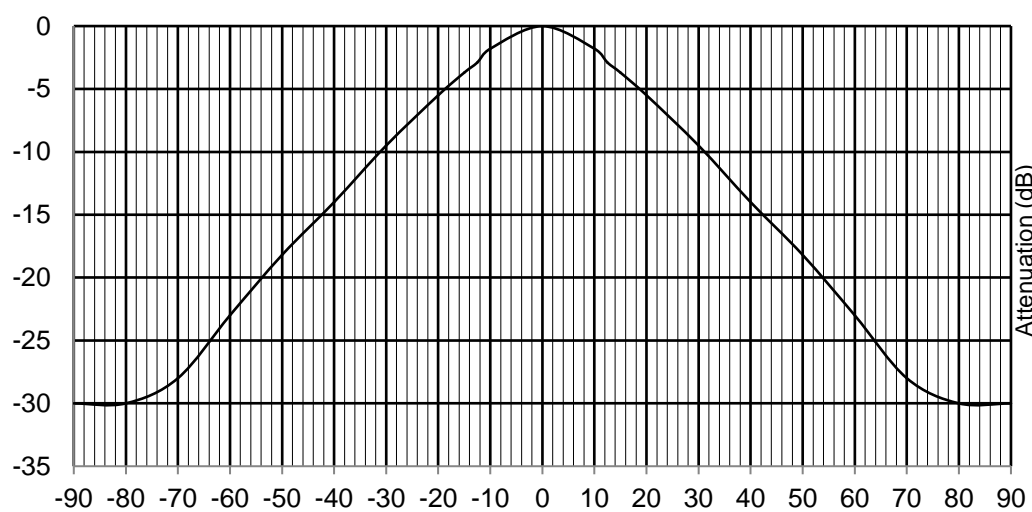
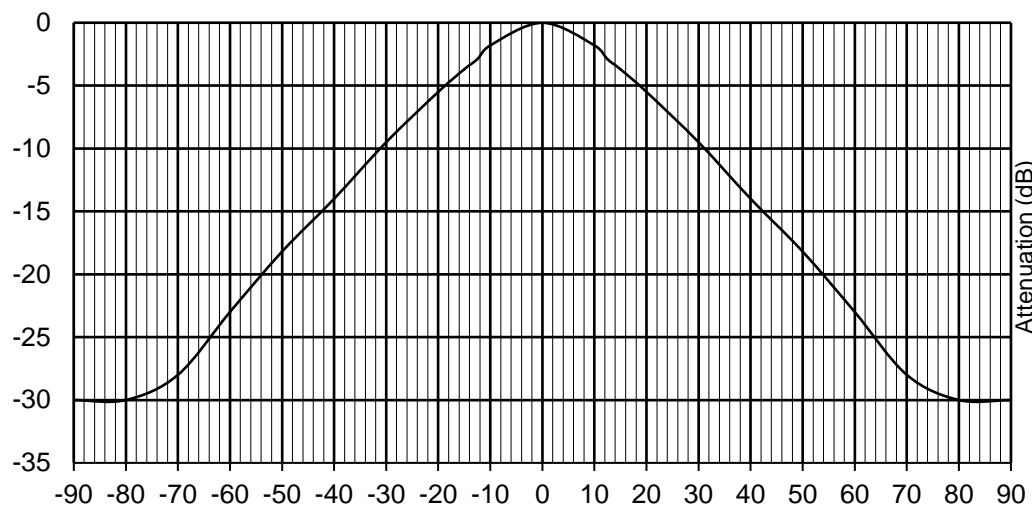

Figure 7: Minimum attenuation of the vertical antenna pattern

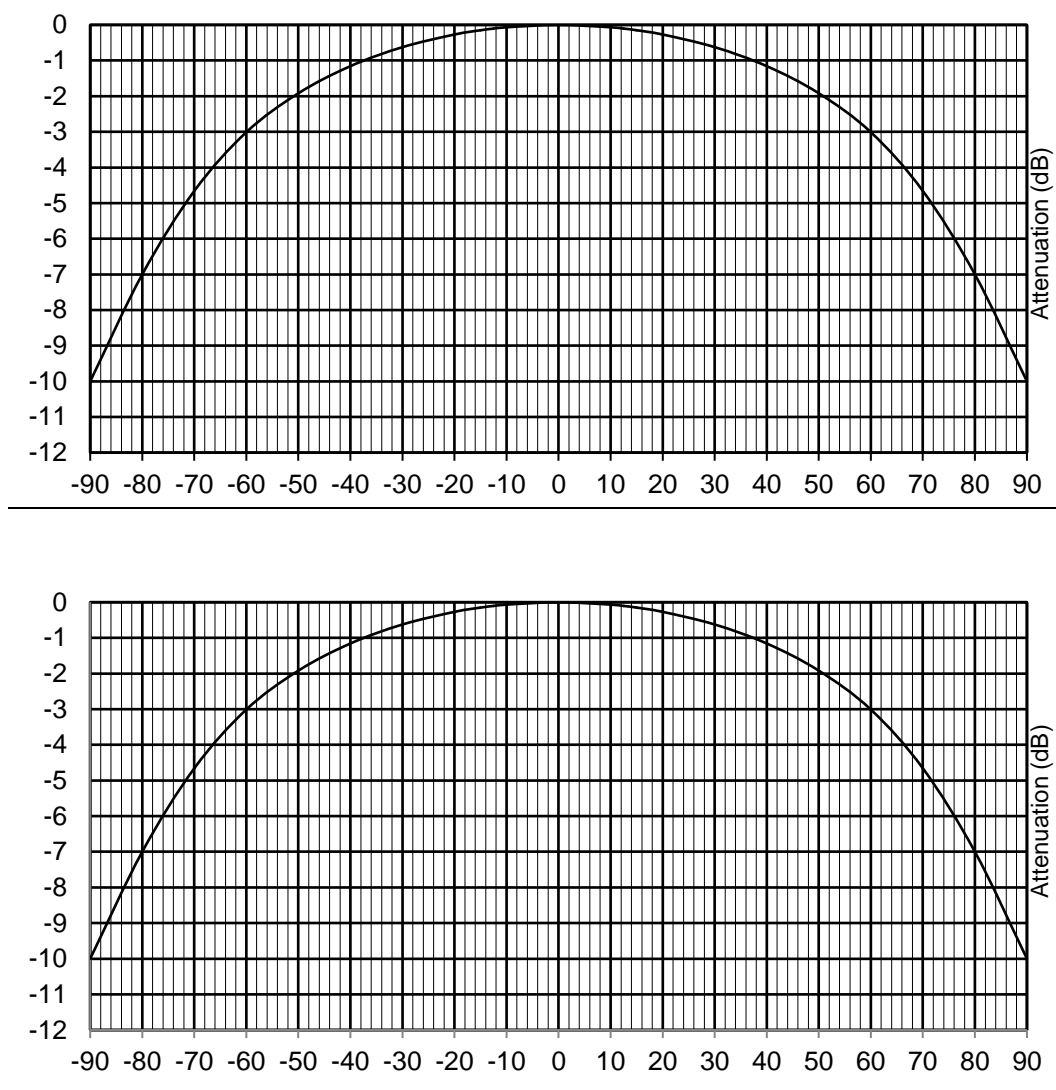

Figure F.8: Minimum attenuation of the horizontal antenna pattern

The difference between the limit curves and the measured values of the EUT antenna (the margin) shall be recorded in the test report.

Annex GJ (informative): Bibliography

ETSI EN 301 489-3 (V1.2.1): "Electromagnetic compatibility and Radio spectrum Matters (ERM); ElectroMagnetic Compatibility (EMC) standard for radio equipment and services; Part 3: Specific conditions for Short-Range Devices (SRD) operating on frequencies between 9 kHz and 40 GHz".

~~CEPT/ERC Recommendation 74-01 (2005): "Unwanted emissions in the spurious domain".~~

Annex HK (informative): Change History

Version	Information about changes
2.1.1	This work includes merging of current versions of part 1 and 2. Revision of current standard parts to cover the essential requirements of article 3.2 of the RE-D. Clarifications in the measurement procedure.
<u>2.2.1</u>	<ul style="list-style-type: none">• <u>Additional Rx-requirement for category 3 receivers: "blocking or desensitization".</u>• <u>Clarification harmonized and non-harmonized frequency ranges covered by the present document.</u>• <u>Clarification text: "General performance criteria".</u>

History

Document history		
Edition 1	December 1995	Publication as ETSI I-ETS 300 440
Corrigendum 1	April 1996	Corrigendum 1 to 1 st Edition of ETSI I-ETS 300 440
V1.3.1/V1.1.1	September 2001	Publication as ETSI EN 300 440 parts 1 and 2
V1.1.2	July 2004	Publication as ETSI EN 300 440- <u>part 2</u>
V1.4.1/V1.2.1	May 2008	Publication as ETSI EN 300 440 parts 1 and 2
V1.5.1/V1.3.1	March 2009	Publication as ETSI EN 300 440 parts 1 and 2
V1.6.1/V1.4.1	August 2010	Publication as ETSI EN 300 440 parts 1 and 2
V2.1.0 ₁	March 2017 May 2016	EN Approval Procedure AP 20160811: 2016-05-13 to 2016-08-11 <u>Publication</u>
V2.1.1 2.0	January September 2017	Vote V 20170310: EN Approval Procedure AP 2017-01-09-18 to 2017-03-10-18
<u>V2.2.1</u>	<u>May 2018</u>	<u>Vote V 20180716: 2018-05-17 to 2018-07-16</u>
V2.2.1 1	March 2017 <u>July 2018</u>	Publication