

# ETSI EN 303 135 V2.2.1 (2020-11)



**Electromagnetic compatibility and  
Radio spectrum Matters (ERM);  
Coastal Surveillance, Vessel Traffic Services and  
Harbour Radars (CS/VTS/HR);  
Harmonised Standard covering the essential requirements for  
access to radio spectrum  
of article 3.2 of the Directive 2014/53/EU**

---

**Reference**

REN/ERM-TGMAR-535

---

**Keywords**

harmonised standard, maritime, radar, regulation

**ETSI**

650 Route des Lucioles  
F-06921 Sophia Antipolis Cedex - FRANCE

Tel.: +33 4 92 94 42 00 Fax: +33 4 93 65 47 16

Siret N° 348 623 562 00017 - NAF 742 C  
Association à but non lucratif enregistrée à la  
Sous-Préfecture de Grasse (06) N° 7803/88

---

**Important notice**

The present document can be downloaded from:

<http://www.etsi.org/standards-search>

The present document may be made available in electronic versions and/or in print. The content of any electronic and/or print versions of the present document shall not be modified without the prior written authorization of ETSI. In case of any existing or perceived difference in contents between such versions and/or in print, the prevailing version of an ETSI deliverable is the one made publicly available in PDF format at [www.etsi.org/deliver](http://www.etsi.org/deliver).

Users of the present document should be aware that the document may be subject to revision or change of status.

Information on the current status of this and other ETSI documents is available at

<https://portal.etsi.org/TB/ETSIDeliverableStatus.aspx>

If you find errors in the present document, please send your comment to one of the following services:

<https://portal.etsi.org/People/CommitteeSupportStaff.aspx>

---

**Copyright Notification**

No part may be reproduced or utilized in any form or by any means, electronic or mechanical, including photocopying and microfilm except as authorized by written permission of ETSI.

The content of the PDF version shall not be modified without the written authorization of ETSI.

The copyright and the foregoing restriction extend to reproduction in all media.

© ETSI 2020.

All rights reserved.

**DECT™**, **PLUGTESTS™**, **UMTS™** and the ETSI logo are trademarks of ETSI registered for the benefit of its Members.

**3GPP™** and **LTE™** are trademarks of ETSI registered for the benefit of its Members and of the 3GPP Organizational Partners.

**oneM2M™** logo is a trademark of ETSI registered for the benefit of its Members and of the oneM2M Partners.

**GSM®** and the GSM logo are trademarks registered and owned by the GSM Association.

# Contents

Intellectual Property Rights .....	5
Foreword.....	5
Modal verbs terminology .....	5
1 Scope .....	7
2 References .....	9
2.1 Normative references .....	9
2.2 Informative references .....	9
3 Definition of terms, symbols and abbreviations.....	10
3.1 Terms .....	10
3.2 Symbols .....	11
3.3 Abbreviations.....	12
4 Technical requirements specifications .....	12
4.1 Environmental profile .....	12
4.2 Conformance requirements .....	12
4.2.1 Transmitter requirements .....	12
4.2.1.1 Frequency Accuracy .....	12
4.2.1.1.1 Definition .....	12
4.2.1.1.2 Limits .....	13
4.2.1.1.3 Conformance.....	13
4.2.1.2 Transmitter power .....	13
4.2.1.2.1 Definition .....	13
4.2.1.2.2 Limits .....	13
4.2.1.2.3 Conformance.....	13
4.2.1.3 Measured Bandwidth.....	13
4.2.1.3.1 Definition .....	13
4.2.1.3.2 Limits .....	13
4.2.1.3.3 Conformance.....	14
4.2.1.4 Out-of-band emissions.....	14
4.2.1.4.1 Definition .....	14
4.2.1.4.2 Limits .....	14
4.2.1.4.3 Conformance.....	19
4.2.1.5 Spurious emissions .....	19
4.2.1.5.1 Definition .....	19
4.2.1.5.2 Limits .....	21
4.2.1.5.3 Conformance.....	21
4.2.1.6 Stand-by Mode Emissions .....	21
4.2.1.6.1 Definition .....	21
4.2.1.6.2 Limits .....	21
4.2.1.6.3 Conformance.....	21
4.2.2 Receiver requirements .....	22
4.2.2.1 System Noise Figure.....	22
4.2.2.1.1 Definition .....	22
4.2.2.1.2 Limits .....	22
4.2.2.1.3 Conformance.....	22
4.2.2.2 Receiver Selectivity .....	22
4.2.2.2.1 Definition .....	22
4.2.2.2.2 Limit .....	22
4.2.2.2.3 Conformance.....	22
4.2.2.3 Receiver Compression Level.....	23
4.2.2.3.1 Definition .....	23
4.2.2.3.2 Limit .....	23
4.2.2.3.3 Conformance.....	23
5 Testing for compliance with technical requirements.....	23
5.0 General requirements .....	23

5.1	Environmental conditions for testing .....	24
5.1.1	Test Conditions .....	24
5.1.2	Normal temperature and humidity .....	24
5.1.3	Normal test power supply .....	24
5.2	Radio test suites .....	25
5.2.1	Transmitter test specification .....	25
5.2.1.1	Frequency Accuracy .....	25
5.2.1.2	Transmitter power .....	25
5.2.1.3	Measured Bandwidth.....	26
5.2.1.4	Out-of-Band-emissions.....	26
5.2.1.5	Spurious emissions .....	30
5.2.1.6	Stand-by Mode Emissions .....	31
5.2.2	Receiver test specification.....	31
5.2.2.1	System Noise Figure.....	31
5.2.2.1.0	General.....	31
5.2.2.2	Receiver Selectivity .....	32
5.2.2.2.0	General.....	32
5.2.2.2.1	Receiver Out-of-Band selectivity.....	32
5.2.2.3	Receiver Compression Level.....	33
<b>Annex A (informative):</b>	<b>Relationship between the present document and the essential requirements of Directive 2014/53/EU .....</b>	<b>35</b>
<b>Annex B (normative):</b>	<b>Transmission power, Frequency Accuracy and Unwanted Emissions of radar systems with indirect methods.....</b>	<b>37</b>
<b>Annex C (normative):</b>	<b>Calculation of the -40 dB Bandwidth.....</b>	<b>38</b>
<b>Annex D (informative):</b>	<b>Maximum Measurement Uncertainty.....</b>	<b>41</b>
<b>Annex E (informative):</b>	<b>WR90/WG16/R100 waveguide characteristics.....</b>	<b>42</b>
<b>Annex F (normative):</b>	<b>Noise figure measurement set-up .....</b>	<b>44</b>
<b>Annex G (normative):</b>	<b>Compression level and selectivity measurement set-up .....</b>	<b>45</b>
<b>Annex H (informative):</b>	<b>Checklist .....</b>	<b>46</b>
<b>Annex I (informative):</b>	<b>Bibliography.....</b>	<b>49</b>
<b>Annex J (informative):</b>	<b>Change history .....</b>	<b>50</b>
History .....		51

---

## Intellectual Property Rights

### Essential patents

IPRs essential or potentially essential to normative deliverables may have been declared to ETSI. The information pertaining to these essential IPRs, if any, is publicly available for **ETSI members and non-members**, and can be found in ETSI SR 000 314: "*Intellectual Property Rights (IPRs); Essential, or potentially Essential, IPRs notified to ETSI in respect of ETSI standards*", which is available from the ETSI Secretariat. Latest updates are available on the ETSI Web server (<https://ipr.etsi.org/>).

Pursuant to the ETSI IPR Policy, no investigation, including IPR searches, has been carried out by ETSI. No guarantee can be given as to the existence of other IPRs not referenced in ETSI SR 000 314 (or the updates on the ETSI Web server) which are, or may be, or may become, essential to the present document.

### Trademarks

The present document may include trademarks and/or tradenames which are asserted and/or registered by their owners. ETSI claims no ownership of these except for any which are indicated as being the property of ETSI, and conveys no right to use or reproduce any trademark and/or tradename. Mention of those trademarks in the present document does not constitute an endorsement by ETSI of products, services or organizations associated with those trademarks.

---

## Foreword

This Harmonised European Standard (EN) has been produced by ETSI Technical Committee Electromagnetic compatibility and Radio spectrum Matters (ERM).

The present document has been prepared under the Commission's standardisation request C(2015) 5376 final [i.1.6] to provide one voluntary means of conforming to the essential requirements of Directive 2014/53/EU on the harmonisation of the laws of the Member States relating to the making available on the market of radio equipment and repealing Directive 1999/5/EC [i.1].

Once the present document is cited in the Official Journal of the European Union under that Directive, compliance with the normative clauses of the present document given in table A.1 confers, within the limits of the scope of the present document, a presumption of conformity with the corresponding essential requirements of that Directive and associated EFTA regulations.

National transposition dates	
Date of adoption of this EN:	<u>18 November 2020</u>
Date of latest announcement of this EN (doa):	<u>28 February 2021</u>
Date of latest publication of new National Standard or endorsement of this EN (dop/e):	31 <u>August 2021</u>
Date of withdrawal of any conflicting National Standard (dow):	31 <u>August 2022</u>

---

## Modal verbs terminology

In the present document "**shall**", "**shall not**", "**should**", "**should not**", "**may**", "**need not**", "**will**", "**will not**", "**can**" and "**cannot**" are to be interpreted as described in clause 3.2 of the [ETSI Drafting Rules](#) (Verbal forms for the expression of provisions).

"**must**" and "**must not**" are **NOT** allowed in ETSI deliverables except when used in direct citation.

---

## Executive Summary

---

# 1 Scope

The present document covers the essential requirements, specifies technical characteristics and methods of measurements for efficient use of radio spectrum by X-band radar sensors intended for Coastal Surveillance, (CS), Vessel Traffic Services and Harbour Radars (CS/(VTS/HR) in the bands between 8 500 MHz to 10 000 MHz using pulsed signals) and a transmitting power up to 100 kW. The present document includes necessary changes due to adaption to the new Radio Equipment Directive [i.1].

---

## Introduction

The present document intends to present a harmonized way of proving compliance to the essential requirements of the RE Directive [i.1] for important types of radar like Coastal Surveillance (CS), Vessel Traffic Services (VTS) and possibly harbour radars.

The emission limits implemented arise from ECC/Recommendation (02)05 [i.3] and ERC/Recommendation 74-01 [i.4].

The test methods used arise from Recommendation ITU R M.1177-4 [2] and Recommendation ITU R SM.1541-5 [1].

NOTE:— The present document is closely related to ETSI EN 303 213-6-1 [i.11] which covers essential requirements for radars used in airport SMGCS systems, but which use largely the same type of radar technology.

The present document is part of a set of standards developed by ETSI and is designed to fit in a modular structure to cover all radio and telecommunications terminal equipment within the scope of the RE Directive [i.1]. The modular structure is shown in ETSI EG 201 399 [i.7].

# 1 Scope

The present document applies to X-band radar sensors intended for use in Vessel Traffic Services (VTS), Coastal Surveillance (CS) or Harbour Radar Systems surveillance with the following characteristics:

- ~~Utilizing~~ Operating in the following frequency range:
  - 8 500 MHz to 10 000 MHz utilizing modulated or unmodulated pulses.
- Transmitter Peak Envelope Power up to 100 kW.
- The ~~transceiver-transmitter output (from power amplifier) towards the antenna connection is using~~ a hollow metallic rectangular waveguide of type WR90/WG16/R100 according to IEC 60153-2 [i.3] with a minimum length of 92 cm (20 times the wavelength of the waveguide cut-off frequency).
- The antenna is rotating, waveguide-based and passive.
- At the transceiver output an RF-circulator is used.

~~NOTE 1: Since transceiver and antenna are hollow metallic rectangular waveguide based, the frequency range for measurements that needs to be addressed covers 6,56 GHz to 26 GHz. The lower limit of this frequency range is obtained as cut off frequency of the combination of WR112/R84 taper section and a WR90/R100 Waveguide as defined by IEC 60153-2 [i.2]. The upper limit corresponds to the upper limit stated in ERC/Recommendation 74-01 [i.4]. Other types of waveguide may be used by the same principles to obtain complete measurement coverage of the frequency range of the output flange of the equipment under test.~~

~~NOTE 2: Since at the transceiver output an RF-circulator is used, it is assumed that the transceiver characteristics remain independent from the antenna.~~

~~NOTE 3: According to article 5 of the ITU Radio Regulations [i.5] there are a number of bands between 8,5 GHz and 10 GHz that are allocated to Radiolocation service. There are national deviations to the detailed band usages, but the basic spectrum usage regulation is the same.~~

**Table 1: Radiolocation service frequency bands [GHz]**

<del>8 500 - 8 550</del>
<del>8 550 - 8 650</del>
<del>8 650 - 8 750</del>
<del>8 750 - 8 850</del>
<del>8 850 - 9 000</del>
<del>9 000 - 9 200</del>
<del>9 200 - 9 300</del>
<del>9 300 - 9 500</del>
<del>9 500 - 9 800</del>
<del>9 800 - 9 900</del>
<del>9 900 - 10 000</del>

~~The present document contains requirements to demonstrate that "...radio equipment shall be so constructed that it both effectively uses and supports the efficient use of radio spectrum in order to avoid harmful interference" [i.1].~~

~~In addition to the present document, other ENs that specify technical requirements in respect of essential requirements under other parts of article 3 of the Radio Equipment Directive [i.1] may apply to equipment within the scope of the present document.~~

NOTE: The relationship between the present document and essential requirements of article 3.2 of Directive 2014/53/EU [i.1] is given in annex A.



## 2 References

### 2.1 Normative references

References are either specific (identified by date of publication and/or edition number or version number) or non-specific. For specific references, only the cited version applies. For non-specific references, the latest version of the referenced document (including any amendments) applies.

Referenced documents which are not found to be publicly available in the expected location might be found at <https://docbox.etsi.org/Reference/>.

NOTE: While any hyperlinks included in this clause were valid at the time of publication, ETSI cannot guarantee their long term validity.

The following referenced documents are necessary for the application of the present document.

- [1] ECC Recommendation ITU-R SM.1541-5 (08-2013)(02)05 (2012): "Unwanted emissions".
- [2] ERC Recommendation 74-01 (2019): "Unwanted emissions in the out-of-band/spurious domain".
- [3] Recommendation ITU-R M.1177-4 (04-2011): "Techniques for measurement of unwanted emissions of radar systems".

### 2.2 Informative references

References are either specific (identified by date of publication and/or edition number or version number) or non-specific. For specific references, only the cited version applies. For non-specific references, the latest version of the referenced document (including any amendments) applies.

NOTE: While any hyperlinks included in this clause were valid at the time of publication, ETSI cannot guarantee their long term validity.

The following referenced documents are not necessary for the application of the present document but they assist the user with regard to a particular subject area.

- [i.1] Directive 2014/53/EU of the European Parliament and of the Council of 16 April 2014 on the harmonisation of the laws of the Member States relating to the making available on the market of radio equipment and repealing Directive 1999/5/EC.
- [i.2] Merrill I. Skolnik: "Radar Handbook", 2nd Edition, McGraw Hill publications.
- [i.3] IEC 60153-2 (Edition 2.0, 1974): 2016: "Hollow metallic waveguides. Part 2: Relevant specifications for ordinary rectangular waveguides".
- ~~[i.3] ECC/Recommendation (02)05 (2012): "Unwanted emissions".~~
- [i.4] ERC/Recommendation 74-01 (2011): "Unwanted emissions in the spurious domain".
- ~~[i.5] ITU Radio Regulations (2012).~~
- ~~[i.6] Void.~~
- ~~[i.7] ETSI EG 201-399: "Electromagnetic compatibility and Radio spectrum Matters (ERM); A guide to 203 336: "Guide for the selection of technical parameters for the production of Harmonized Standards for application under the Radio & Telecommunication Terminal Equipment Directive 1999/5/EC (R&TTE) and a first guide on the impact of the Radio Equipment Directive 2014/53/EU (RED) on Harmonized Standards".~~
- [i.8] Void.

- [i.9] ~~ETSI TR 100 028 (all parts) (V1.4.1) (12-2001): "Electromagnetic compatibility and Radio spectrum Matters (ERM); Uncertainties in the measurement of mobile radio equipment characteristics".~~
- [i.10] ~~ETSI TR 100 028 2 (V1.4.1) (12-2001): "Electromagnetic compatibility and Radio spectrum Matters (ERM); Uncertainties in the measurement of mobile radio equipment characteristics; Part 2".~~
- [i.11] ~~ETSI EN 303 213 6 1: "Advanced Surface Movement Guidance and Control System (A-SMGCS); Part 6: Harmonised Standard Standards covering the essential requirements of article 3.1(b) and article 3.2 of the Directive 2014/53/EU for deployed surface movement radar sensors; Sub-part 1: X-band sensors using pulsed signals and transmitting power up to 100 kW".~~
- [i.5] Recommendation ITU-R SM.1541-6 (08/2015): "Unwanted emissions in the out-of-band domain".
- [i.6] Commission Implementing Decision C(2015) 5376 final of 4.8.2015 on a standardisation request to the European Committee for Electrotechnical Standardisation and to the European Telecommunications Standards Institute as regards radio equipment in support of Directive 2014/53/EU of the European Parliament and of the Council.
- [i.7] Definitions ITU Radio Regulations (2016).

## 3 3 Definition of terms, symbols and abbreviations

### 3.1 Definitions

#### 3.1 Terms

For the purposes of the present document, the following terms ~~and definitions~~ apply:

**active state:** state producing the authorized emission

**allocated band:** frequency span that regionally or nationally is allocated to one or more radio services on a primary or secondary basis

NOTE: A table of national frequency allocations are normally available from the radio authority for each national state. Also a generic frequency allocation table is available in the ITU Radio Regulations [i.7].

**declared band:** band or bands within which the product under test is declared to operate in the applicable operating modes

NOTE: The declared band for a given region or country is always contained within the allocated band.

**idle/standby state:** state where the transmitter is available for traffic, but is not in the active state

**Minimum Detectable Signal (MDS):** measure of the lowest detectable signal amplitude for a given signal type for a given radar

NOTE: For solid state radars a processing gain can be associated with a received signal. This processing gain has the effect of lowering the MDS level in comparison to a MDS which is based only on noise temperature.

**necessary bandwidth:** width of the frequency band which is just sufficient to ensure the transmission of information at the rate and with the quality required under specified conditions for a given class of emission

NOTE: This definition is taken from ITU Radio Regulations [i.7].

**occupied bandwidth:** width of a frequency band such that, below the lower and above the upper frequency limits, the mean powers emitted are each equal to a specified percentage  $\beta/2$  of the total mean power of a given emission

NOTE 1: This definition is taken from ITU Radio Regulations [i.7].

NOTE 2: Unless otherwise specified in ~~an~~ Recommendation ITU-R\_ for the appropriate class of emission, the value of  $\beta/2$ -should-be-taken-as-0,5 %.

**peak envelope power:operating mode:** predefined configuration for a given service accessible to the operator of the radar system

NOTE 1: Several operating modes may be available.

NOTE 2: Changing operating mode might affect the radio characteristics of the radar system.

**Peak Envelope Power (PEP):** average power supplied to the antenna transmission line by a transmitter during one radio frequency cycle at the crest of the modulation envelope taken under normal operating conditions

NOTE: This definition is taken from ITU Radio Regulations [i.7].

**product configuration:** hardware variant of the same typology of system under test (e.g. different power outputs, magnetrons)

**pulse duration:** time between the 50 % amplitude (voltage) points

**pulse rise time:** time taken for the leading edge of the pulse to increase from 10 % to 90 % of the maximum amplitude (voltage)

**receiver selectivity:** ability of a receiver to detect and decode a desired signal in the presence of an unwanted interfering signal outside the  $B_{-40}$  bandwidth

**simple pulse radar:** radar using pulsed emissions but not using frequency, phase or power modulation

## 3.2 Symbols

For the purposes of the present document, the following symbols apply:

$B_{-40}$	-40 dB bandwidth
$B_C$	Chirp bandwidth
$B_N$	Necessary bandwidth
<del><math>B_S</math></del>	<del>Maximum range over which the carrier frequency is shifted</del>
$B_{res}$	3 dB resolution bandwidth of transceiver
dB/dec	dB per decade
$dBpp$	dB with respect to peak power
<del><math>D_{no\ spur}</math></del>	<del>Detectability Factor (function of PD &amp; Pfa)</del>
$k$	Boltzmann's constant
<del><math>NF_{sys}</math></del>	<del>Noise Factor of the system</del>
<del><math>P_D</math></del>	<del>Probability of detection</del>
<del><math>P_{FA}</math></del>	<del>Probability of false alarm</del>
$P_t$	Pulse power of transmission
$t$	Time
$t_p$	Pulse duration
$t_r$	Pulse rise time
<del><math>t_f</math></del>	<del>Pulse fall time</del>
<del><math>T_0</math></del>	<del>Temperature in Kelvin</del>
$T_C$	Pulse length <del>including rise &amp; fall times</del> (of individual chirp) in seconds
$\lambda$	Wavelength

### 3.3 Abbreviations

For the purposes of the present document, the following abbreviations apply:

AC	Alternating Current
CS	Coastal Surveillance
CW	Continous Wave
dBm	Power ratio expressed in decibels (dB) with reference to one milliwatt
dBW	Power ratio expressed in decibels (dB) with reference to one Watt
EFTA	European Free Trade Association
EM	ElectroMagnetic
EN	European Norm
FM	Frequency Modulation
HR	<del>Harbor Radar</del> HaRbour
kW	kiloWatt
LNA	Low Noise Amplifier
LO	Local Oscillator
MDS	Minimum Detectable Signal
NA	Not Applicable
OoB	Out-of-Band
PEP	Peak Envelope Power
<del>RED</del>	<del>Radio Equipment Directive</del>
PPI	Plan Position Indicator (Display showing the radar video etc)
ppm	part(s) per million
RF	Radio Frequency
VTS	Vessel Traffic Services
WG	WaveGuide

---

## 4 Technical requirements specifications

### 4.1 Environmental profile

The technical requirements of the present document apply under the environmental profile for operation of the equipment, which shall be ~~declared by the supplier~~ in accordance with its intended use, but as a minimum, shall be that specified in the test conditions contained in the present document. The equipment shall comply with all the technical requirements of the present document at all times when operating within the boundary limits of the ~~declared~~ operational environmental profile defined by its intended use.

### 4.2 Conformance requirements

#### 4.2.1 Transmitter requirements

##### 4.2.1.1 Operating frequency

##### 4.2.1.1 Frequency Accuracy

##### 4.2.1.1.1 Definition

The transmitter of a pulsed radar produces microwave pulses, which cause a broad frequency spectrum, depending on the pulse duration.

~~In the present document the operating~~The frequency accuracy is considered to be ~~the~~ the maximum permissible departure by the centre frequency of the microwave frequency band occupied by an emission during from the assigned frequency or, by the transmitting pulse and is represented by the spectral line characteristic frequency of highest amplitude ~~an emission from the reference frequency.~~

~~NOTE: It is only practicable to indicate an~~ 4.2.1.1.2 Limits

~~The frequency accuracy at the defined operating frequency for radars with unmodulated pulses. In this case a limit for the frequency tolerance is specified. For radars with modulated pulses such a limit is not applicable. In any case the occupied bandwidth is completely contained in the allocated frequency band(s).~~

#### Limits

~~The frequency tolerance for a radar applying unmodulated pulses shall be  $\pm 30$  MHz not exceed 1 250 ppm.~~

~~For all radar types covered by the present document the occupied bandwidth of the signal shall be contained completely within the allocated band in use (e.g. 9 300 MHz to 9 500 MHz) in all operating modes.~~

NOTE: This value is defined in appendix 2 of the ITU Radio Regulations [i.7].

#### 4.2.1.1.3 Conformance

~~The conformance tests are specified in clause 5.3.1.1-5.2.1.1.~~

~~The results obtained shall not exceed the limits specified in clause 4.2.1.1.2.~~

#### 4.2.1.2 Transmitter power

##### 4.2.1.2.1 Definition

~~In the present document the transmitter power of a pulse radar is considered to be the peak value of the transmitter pulse power during the transmission pulse (PEP) measured at the antenna flange (output port of the transmitter).~~

~~If the transmitter power varies over the azimuth, the highest PEP over at least one rotation period has to be used.~~

##### 4.2.1.2.2 Limits

~~The transmitter power shall be referenced with respect to the output port of the radar transmitter, not exceed 100 kW (50 dBW).~~

##### ~~#~~4.2.1.2.3 Conformance

~~The conformance tests are specified in clause 5.2.1.2.~~

~~The results obtained shall not exceed the transmitter power can be varied according to azimuth, the highest PEP value limits specified in clause 4.2.1.2.2.~~

#### 4.2.1.3 Measured Bandwidth

##### 4.2.1.3.1 Definition

~~The measured during -40 dB bandwidth ( $B_{-40}$ ) is the measured bandwidth of the emission 40 dB below the measured PEP.~~

~~The measured -20 dB bandwidth ( $B_{-20}$ ) is the measured bandwidth of the emission 20 dB below the measured PEP.~~

##### 4.2.1.3.2 Limits

~~For radar types using a period equal to at least one rotation period modulated pulse the measured -40 dB bandwidth of the signal shall be contained completely within the declared band in all operating modes.~~

~~In case of multiple carrier-frequencies, all measured -40 dB emissions shall be used contained within the declared band.~~

~~For magnetron radars the measured -20 dB bandwidth of the signal shall be contained completely within the declared band. In case of multiple carrier-frequencies magnetron radars, all measured -20 dB emissions shall be contained within the declared band.~~

NOTE: Magnetron radars will not be able to fit the -40 dB bandwidth within the band due to the physical properties of this technology and the requirements for the minimal operational performance.

#### 4.2.1.3.3 Conformance

The conformance tests are specified in clause 5.2.1.3.

The results obtained shall not exceed the limits specified in clause 4.2.1.3.2.

#### 4.2.1.4 Out-of-band emissions

##### 4.2.1.4.1 Definition

Out-of-Band emissions refer to emissions in the region between the calculated -40 dB bandwidth and the spurious region (see definition of spurious region in clause 4.2.1.5.1).

The Out-of-Band emission limits and the spurious emission limits are defined based on the calculated -40 dB bandwidth. Annex C contains the applicable formulae for calculating the -40 dB bandwidth.

For radars with multiple carrier frequencies, the overall emission mask is obtained by superimposing the emission masks of each individual carrier frequency. An example can be seen in figure 1.

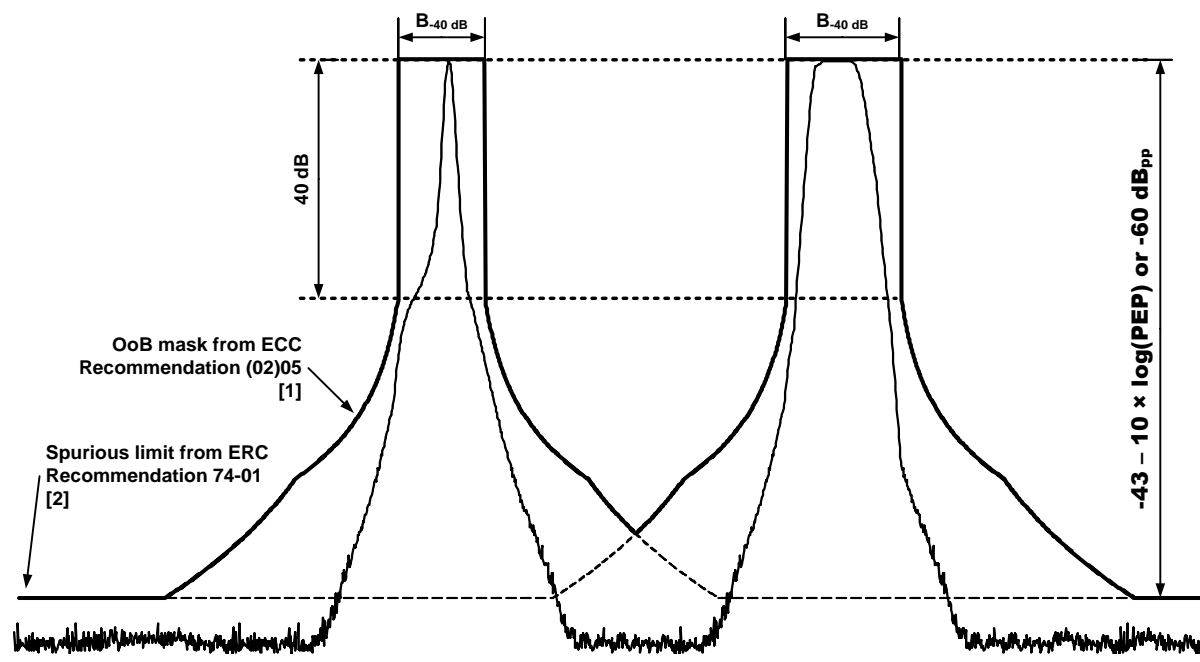

**Figure 1: Example of superimposed (combined) mask from two carrier frequencies**

##### 4.2.1.4.2 Limits

The transmitter powerThe limits for the OoB spectrum mask shall be as specified by the manufacturer with an accuracy of at least  $\pm 2$  dB. The peak power value shall not exceed 100 kW (50 dBW).

##### Conformance

The conformance tests are specified in clause 5.4.1.2.

### 4.2.1.3 Out-of-band emissions

#### 4.2.1.3.1 Definition

An important parameter of the Out-of-Band (OoB) emissions mask of the radar is the -40 dB bandwidth. Annex 8 of in annex 2 of ECC Recommendation ITU-R SM.1541-5 [1] specifies the -40 dB bandwidth specified for various types of waveforms (e.g. (02)05 [1], ~~pulsed radar signals~~). With the following assumptions which apply to most airport surface movement radars these specifications can be further simplified:

- the radar is operating in a band within the limits 8 500 MHz to 10 000 MHz;
- the pulse power is below 100 kW;
- the pulse rise time  $t_r$  is greater than 0,0094  $t$ , where  $t$  is the pulse duration.

~~With the aforementioned assumptions the -40 dB bandwidth ( $B_{-40}$ ) for primary non-FM pulse radars can be determined as follows:~~

$$B_{-40} = \frac{7.6}{\sqrt{t \times t_r}}$$

~~Where:~~

- $t$  is the pulse duration;
- ~~$t_r$  is the rise time in the case of a trapezoidal pulse.~~

~~NOTE: For typical values of a pulse duration of  $t = 50$  ns and a rise time of  $t_r = 10$  ns the formula above yields a -40 dB The Out-of-Band emission limits are defined based on the -40 dB bandwidth value of 340 MHz.~~

~~For radars with multiple pulse waveforms, the ( $B_{-40}$  bandwidth should be calculated for each individual pulse type and the maximum  $B_{-40}$  bandwidth obtained shall be used to establish the shape of the emission). The Out of Band mask:~~

~~For radars with a highly asymmetrical spectrum, the  $B_{-40}$  rolls off at 30 dB bandwidth can be offset per decade, from the frequency of maximum emission level, but the necessary bandwidth,  $B_N$ , and preferably the overall occupied bandwidth should be contained completely within the allocated band as stipulated in section 4 of Annex 8 of Recommendation ITU-R SM.1541-5 [1].  $B_{-40}$  bandwidth to the level specified for spurious emissions.~~

~~The application of this rule is illustrated in Figure 1.~~

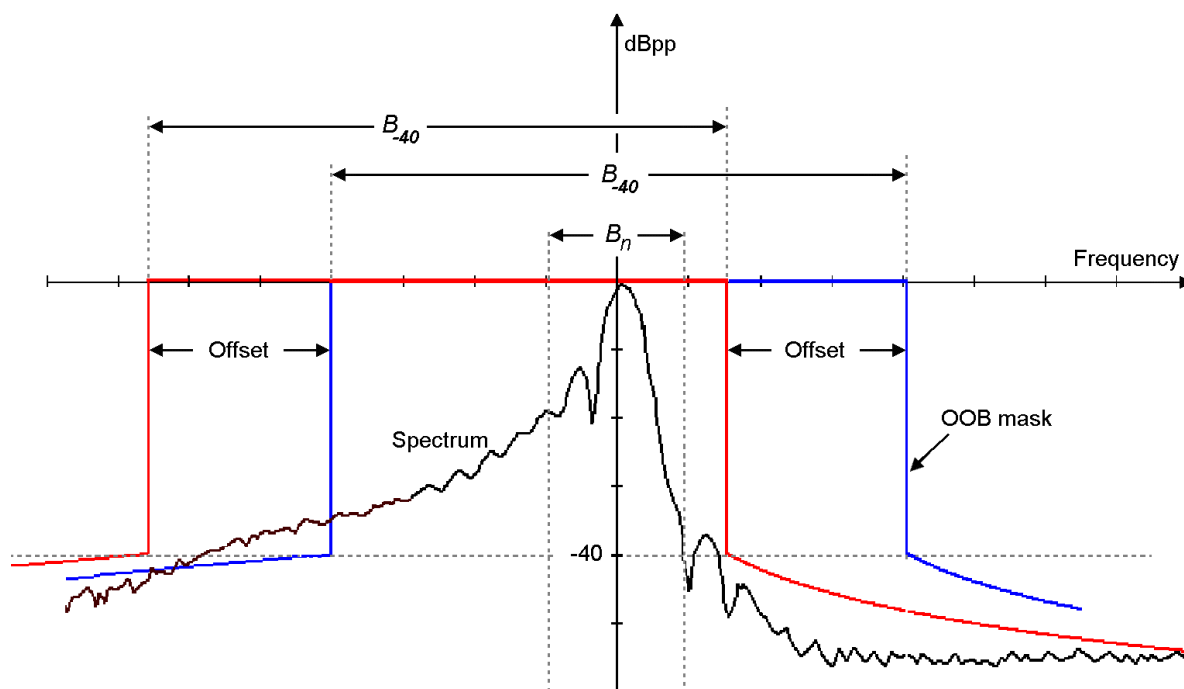

Figure 1: Application of the offset rule. For multi-frequency/frequency diversity and active array radars spurious emission limits shall be  $43 + 10\log(\text{PEP})$  or  $60 \text{ dB}_{\text{pp}}$  (whichever is less stringent) as specified in table 15 of ERC Recommendation 74-01 [2] and in table 1.

**Table 1: Limits for unwanted emissions for the Out-of-Band emission limit mask**

For FM pulsed radars the  $B_{-40}$  can be calculated as follows:

$$B_{-40} = 1.5 \cdot \left\{ B_C + \sqrt{\pi} \cdot [\ln(B_C \cdot \tau)]^{0.53} \cdot \left[ \text{Min}(B_{\text{rise}}, B_{\text{fall}}, B_{\text{rise\&fall}}) + \text{Max}(B_{\text{rise}}, B_{\text{fall}}, B_{\text{rise\&fall}}) \right] \right\} + B_S$$

where

$$B_{\text{rise}} = \frac{1}{\sqrt{\tau \cdot t_r}}$$

$$B_{\text{fall}} = \frac{1}{\sqrt{\tau \cdot t_f}}$$

$$B_{\text{rise\&fall}} = \frac{1}{\sqrt[3]{\tau \cdot t_r \cdot t_f}}$$

Where:

$B_{-40}$  is the -40 dB bandwidth in Hz;

$B_C$  is the bandwidth of the frequency deviation (total frequency shift during the pulse generation);

$B_S$  is the maximum range over which the carrier frequency will be shifted,  $B_S$  equals zero for non-frequency hopping cases. It is zero in case of a single carrier multiple frequency; and active arrays

$\tau$  is the pulse length including rise & fall times;

$t_r$  is the risetime in seconds;

$t_f$  is the falltime in seconds.



<u>Frequency offset relative to <math>B_{40}</math></u>	<u>Limit dB<sub>pp</sub></u>	<u>Slope dB/decade</u>
0,5 to 2,3	-40 to -43 - 10 x log(PEP) / -60 (see note)	-30
NOTE: From -40 to -43 - 10 x log(PEP) or -60 whichever is less stringent.		

For all other radar systems with multiple carriers, the OoB domain should start at the edges of the total assigned bandwidth. This means that the effective  $B_{40}$  is from the lower end of the calculated  $B_{40}$  of the lowest radar frequency to the high end of the  $B_{40}$  for the highest radar frequency.

In general the OoB domain shall be determined according to Recommendation ITU R SM.1541-5 [1], but the examples above are valid for the most commonly used modulation types.

### Limits

NOTE 1: In a future version of the present document more stringent requirements for OoB Emissions based on the design objective case in ECC/Recommendation (02)05 [i.3] (the solid line in Figure A2.1c of [i.3] with a slope of 40 dB/decade) may need to be considered.

The maximum Out of Band emission power level shall not exceed the limits stated in Table 1a and the corresponding mask depicted in Figure 2. The roll off of the OoB mask beyond the 40 dB bandwidth,  $B_{40}$  in relation to  $B_{40}$  is specified as follows:

- The mask has a roll off at 30 dB/dec from the calculated (identified)  $B_{40}$  bandwidth to a level of -70 dBpp. The mask then continues to roll off at 60 dB/dec to a spurious emission limit level of -100 dBpp.

NOTE 2: This mask corresponds to the limit specification in Annex 2 of limits shall be ~~i.e.~~ the dashed line in Figure A2.1c of ECC/Recommendation (02)05 [i.3].

- If an absolute limit of -30 dBm can be more easily achieved this limit applies instead of -100 dBpp.

NOTE 3: ERC/Recommendation 74-01 [i.4] stipulates in its Table 1a for fixed radars a spurious emission limit in the reference bandwidth of "30 dBm or 100 dB, or 100 dB<sub>pp</sub> (whichever is less stringent)" as specified in table 15 of ERC Recommendation 74-01 [2] and in table 2.

**Table 2a: Limits for unwanted emissions for all other radar systems**

<u>Frequency offset relative to <math>B_{40}</math></u>	<u>Limit dBpp</u>	<u>Slope dB/decade</u>
0 to 0,5	0	0
0,5	-40	-∞
0,5 to 5	-40 to -70	-30
5 to 15,8	-70 to -100 / -30 dBm	-60
15,8 to ∞	-100 / -30 dBm	0

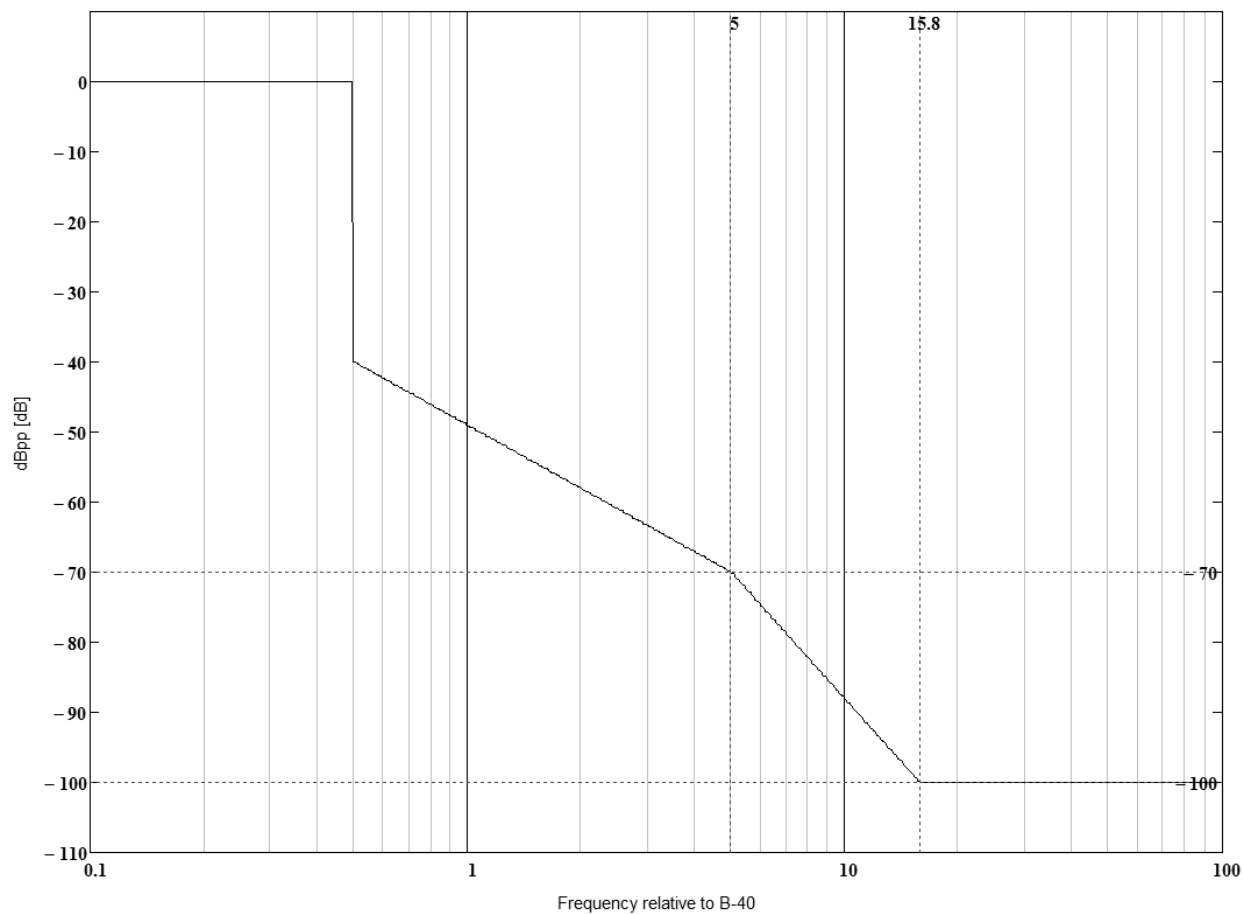

<b>Frequency offset relative to <math>B_{-40}</math></b>	<b>Limit <math>dB_{pp}</math></b>	<b>Slope dB/decade</b>
0,5 to 5	-40 to -70 dB	-30
5 to 15,8	-70 to -100 dB / -30 dBm (see note)	-60

NOTE: From -70 to -100 dB or -30 dBm whichever is less stringent.

Example of the unwanted emission mask per table 2 is shown in figure 2.

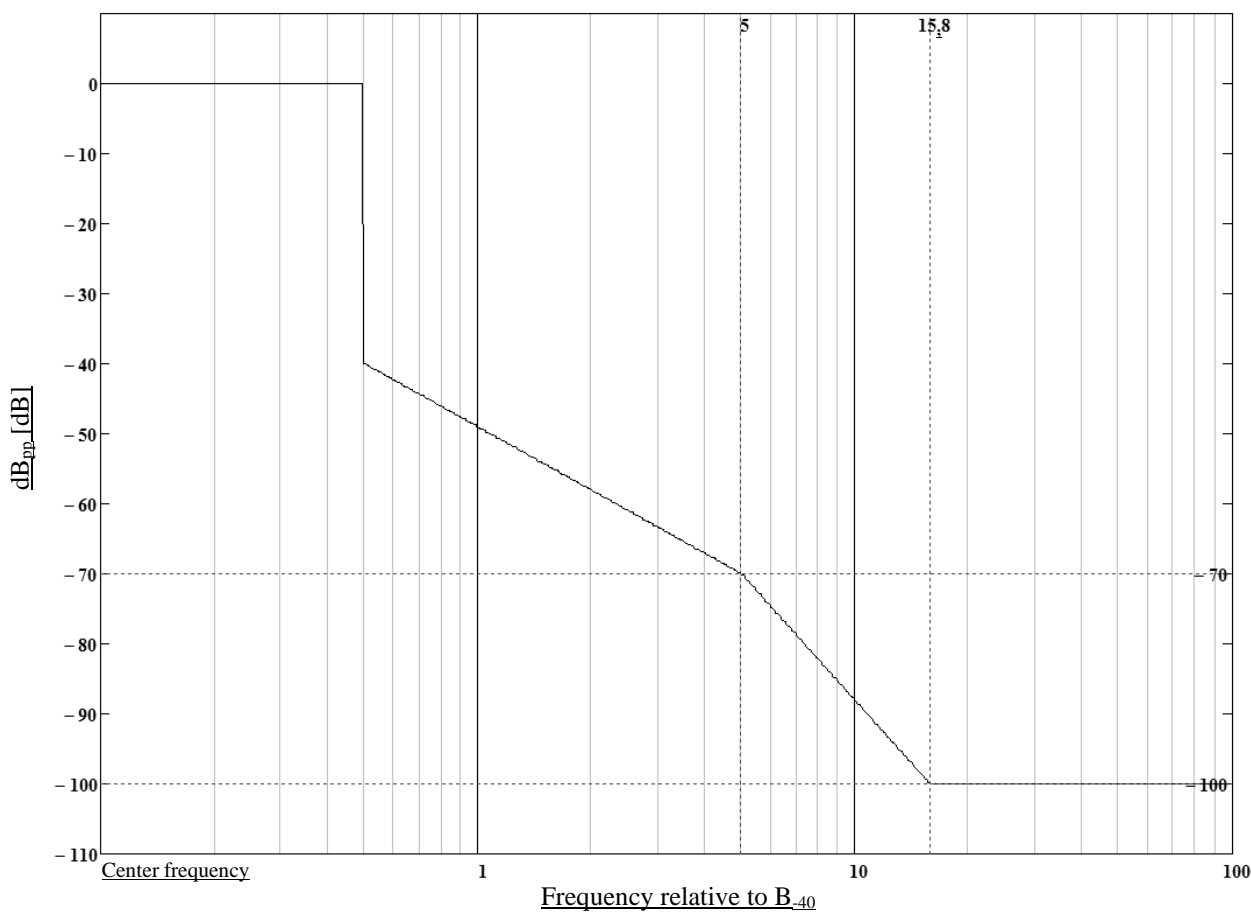

**Figure 2-2: Out-of-Band emission limit masks**

#### 4.2.1.4.3 Conformance

The conformance tests are specified in clause [5.3.1.3.5.2.1.4](#).

The results obtained shall not exceed the limits specified in clause [4.2.1.4.2](#).

#### 4.2.1.5 Spurious emissions

##### 4.2.1.5.1 Definition

Spurious emissions are defined as the entity of all emissions in the frequency range of the cut-off frequency 6,56 GHz of the waveguide section to 26 GHz, but unwanted emissions in the spurious domain. For active transmitters, the spurious domain is all frequencies outside the OoB boundaries domain as shown in figure 3.

**NOTE:** The lower limit of this frequency range of 6,56 GHz is obtained as cut-off frequency of the combination of WR112/R84 taper section and a WR90/R100 Waveguide as defined in IEC 60153-2 [i.2]. The upper limit corresponds to the upper limit stated in ERC/Recommendation 74-01 [i.4].

They include:

- harmonic emissions (whole multiples of the operating frequency);
- parasitic emissions (independent, accidentally);
- intermodulation (between oscillator- and operation frequency or between oscillator and harmonics);
- emissions caused by frequency conversions.

The boundaries between OoB domain and the spurious domain are where the OoB limit mask specified in ECC/ Recommendation (02)05 [1], annex 2 reaches the spurious emission limit specified in table 15 of -100 dBpp according to ERC/ Recommendation-74-01 [2], annex 5. This is illustrated in Figure 3.

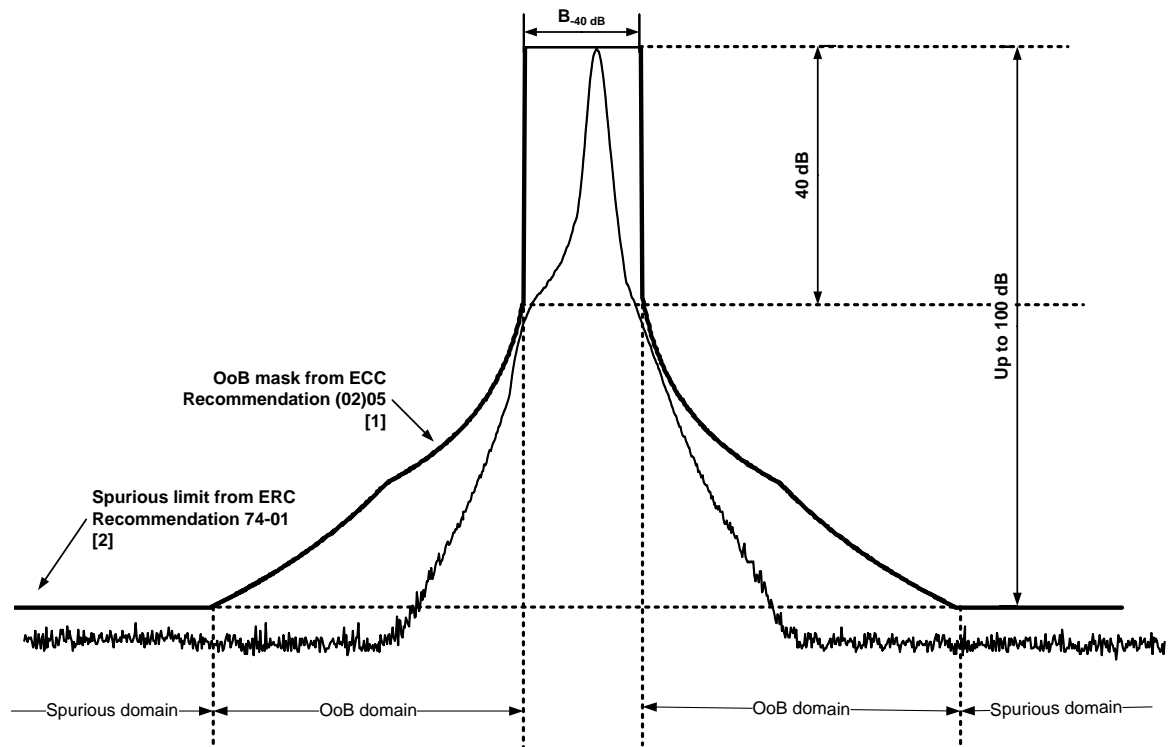
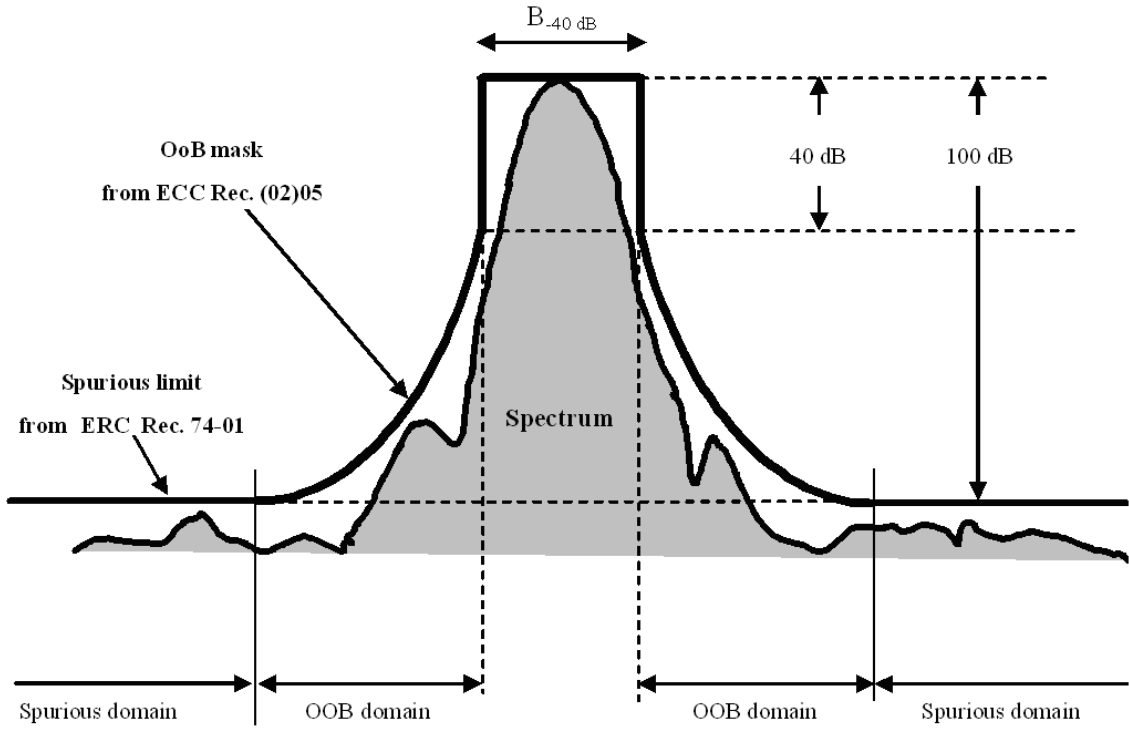

Figure 3:3: Definition of OoB and spurious emission domains (Not (not to scale))

#### 4.2.1.4.2      4.2.1.5.2 Limits

For radar systems, the spurious emissions limits are related to the following requirement based on Table 5.1 in Annex 5 for the case of fixed stations in PEP and shall be as specified in ERC Recommendation 74-01 [2] apply, annex 5 and also shown in table 3.

#### **All Table 3: Limits for spurious emission levels radar equipment shall have emissions**

— a minimum attenuation of 100 dB or a maximum power 30 dBm, whichever is less stringent;

measured as PEP in the	
Radar type	Spurious emission limits
Multi-frequency and active array	-43 - 10 × log(PEP) dB or -60 dB (see notes 1 and 2)
Other types of fixed stations	-100 dB or -30 dBm (see note 1)
NOTE 1: Whichever is less stringent.	
NOTE 2: PEP is measured in Watts in the reference bandwidth of 1 MHz.	

NOTE: A reference bandwidth of 1 MHz is recommended for frequencies above 1 GHz as in ERC Recommendation 74-01 [2].

#### 4.2.1.5.3      Conformance

The conformance tests are specified in clause 5.3.1.4-5.2.1.5.

The results obtained shall not exceed the limits specified in clause 4.2.1.5.2.

#### 4.2.1.6      Stand-by Mode Emissions

##### 4.2.1.6.1      Definition

The idle/standby state is defined as the state where the transmitter is available for operation but is not in the active state. The receiver shall be activated.

The stand-by mode output power is defined as the power output at the antenna flange in the spurious region.

For the stand-by mode the limits between OoB and spurious regions are considered the same as calculated for the active state.

##### 4.2.1.6.2      Limits

The standby mode emissions shall be not greater than -47 dBm above 1 GHz as specified in table 15 of annex 5 of ERC Recommendation 74-01 [2].

The radars covered by the present document use WR90 waveguides to transfer power between the transmitter and the antenna and the waveguide cut-off frequency is 6 556 MHz. Therefore, measurements below this frequency do not provide valid results since the waveguide is unable to support power transfer along its length below the cut-off frequency.

##### 4.2.1.6.3      Conformance

The conformance tests are specified in clause 5.2.1.6.

The results obtained shall not exceed the limits specified in clause 4.2.1.6.2.

## 4.2.2 Receiver requirements

### 4.2.2.1 System Noise Figure

#### 4.2.2.1.1 Definition

The system noise figure measures the degradation of the signal-to-noise ratio, caused by components in the radio-frequency signal chain.

#### 4.2.2.1.2 Limits

The maximum system Noise Figure shall be 6 dB.

#### 4.2.2.1.3 Conformance

The conformance tests are specified in clause 5.2.2.1.

The results obtained shall not exceed the limits specified in clause 4.2.2.1.2.

### 4.2.2.2 Receiver Selectivity

#### 4.2.2.2.1 Definition

~~The input~~ The receiver selectivity is the ability of a receiver to reject interfering signals outside the B<sub>-40</sub> bandwidth.

NOTE: Signals inside the B<sub>-40</sub> bandwidth are not considered as interfering signals because they fall into the desired frequency range for the reception of wanted signals.

#### 4.2.2.2.2 Limit

~~The receiver selectivity characteristic of the radar receiver shall be commensurate with~~ correspond to the requirements for the spectrum of the emitted signal as specified in clause 4.2.1.3-4.2.1.4.

~~This means that the sensitivity of a radar system shall be decreased in the Out-of-Band region in the same degree as the permitted emission spectrum.~~

#### Limit

~~In the spurious region a radar system shall not be able to detect signals lower than -100 dBpp or a maximum signal level of -30 dBm.~~

The receiver input shall be subjected to a disturbing signal swept over the frequency ranges from WG cut-off to the lower edge of the -40 dB bandwidth and from the higher edge of the -40 dB bandwidth to 26 GHz.

The disturbing signal level shall start at the Minimum Detectable Signal (MDS) level from the -40 dB bandwidth edges of the radar emissions. Then the disturbing signal level shall rise with 30 dB/decade until it reaches the maximum level 6 dB below receiver compression point but not higher than -30 dBm.

The detailed derivation of the receiver Out-of-Band selectivity curve is described in clause 5.2.2.2.

#### 4.2.2.2.3 Conformance

The conformance tests are specified in clause 5.3.2.1-5.2.2.2.

The results obtained shall not exceed the limits specified in clause 4.2.2.2.2 and clause 5.2.2.2.

### 4.2.2.3 Receiver Compression Level

#### 4.2.2.3.1 Definition

The compression level is defined as when one of the receiver stages becomes non-linear thereby causing distortion and other non-linear effects that prevent proper operation of the receiver.

The receiver input compression level is defined as when the receiver output is 1 dB into compression as shown in figure 4.

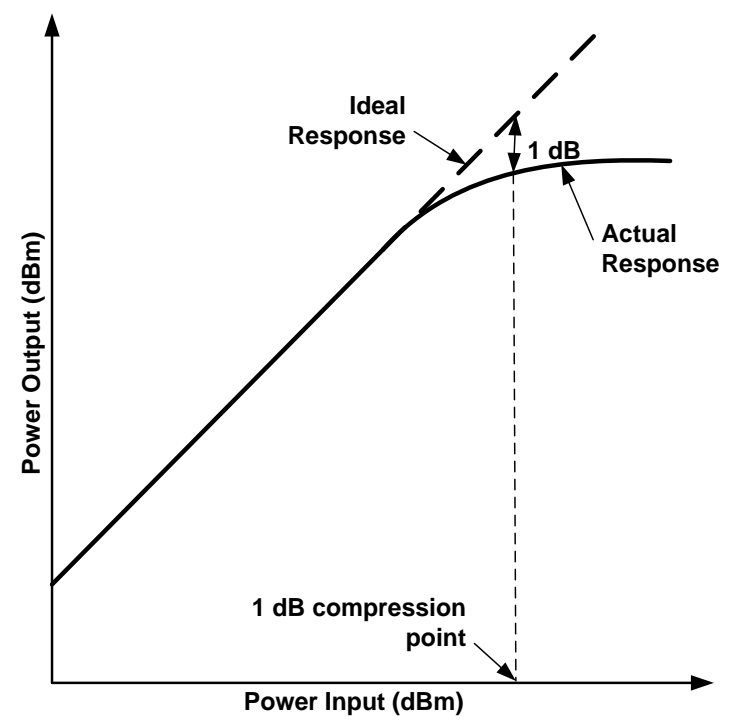

**Figure 4: Receiver 1 dB compression point**

#### 4.2.2.3.2 Limit

The input of the radar shall be able to handle signal levels up to at least -35 dBm (measured at the waveguide flange) with no more than 1 dB compression of the signal, refer to figure 4. The measurement of compression signal level shall be done at the output of the A/D driver amplifier (analog) or by data analysis at the output of the A/D converter (digital).

NOTE: A high compression level corresponds to high immunity against blocking.

#### 4.2.2.3.3 Conformance

The conformance tests are specified in clause 5.2.2.3.

The results obtained shall not exceed the limits specified in clause 4.2.2.3.2.

## 5 Testing for compliance with technical requirements

### 5.0 General requirements for testing

For the purpose of the compliance tests described in the present document, the radar under test shall be set up in a realistic operation mode. This means that the transceiver shall be operating and set up with parameters which produce

the worst case spectrum in realistic use (e.g. shortest pulse length, highest peak frequency deviation). Furthermore, the radar shall be supplied with the necessary signals (e.g. antenna azimuth encoder signal, safety loop signals) to simulate normal operation.

~~NOTE: The standard operating parameters depend very much on the type of the radar.~~

The manufacturer shall ensure that all operating modes and product configurations are in compliance with the technical requirements in the present document.

## 5.1 Environmental conditions for testing

### ~~Introduction~~

### ~~Unless otherwise stated, all~~ 5.1.1 Test Conditions

All tests shall take place under the following normal test conditions specified in clause 5.1.2 and clause 5.1.3.

### ~~5.1.2~~ Standard operation mode for testing

~~During the tests the radar equipment shall be operated in the standard operation mode. This means that the transceiver shall be operating and set up with parameters which produce the worst case spectrum in realistic use i.e. with shortest pulse length and highest peak frequency deviation. Furthermore, the radar shall be supplied with the necessary signals i.e. antenna azimuth encoder signal and safety loop signals to simulate normal operation.~~

~~NOTE: The standard operating parameters depend very much on the type of the radar.~~

### 5.1.2 Normal temperature and humidity

The temperature and humidity conditions for tests shall be a combination of temperature and humidity within the following ranges:

- a) temperature: +15 °C to +35 °C;
- b) relative humidity: ~~20 % to~~ not exceeding 75 %.

~~When the relative humidity is lower than 20 %, it shall be stated in the test report.~~

### 5.1.3 Normal test power supply

The test voltage for equipment to be connected to an AC supply shall be the nominal mains voltage declared by the manufacturer -10 % to +10 %. For the purpose of the present document, the nominal voltage shall be the declared voltage or each of the declared voltages for which the equipment is indicated as having been designed. The frequency of the test voltage shall be 50 Hz ± 1 Hz.

## ~~5.2~~ Interpretation of the measurements results

The interpretation of the results recorded in a test report for the measurements described in the present document shall be as follows:

- ~~• the measured value related to the corresponding limit will be used to decide whether an equipment meets the requirements of the present document;~~
- ~~• the value of the measurement uncertainty for the measurement of each parameter shall be included in the test report;~~
- ~~• the recorded value of the measurement uncertainty shall be, for each measurement, equal to or lower than the figures in Table 2.~~



For the test methods, according to the present document, the measurement uncertainty figures shall be calculated and shall correspond to an expansion factor (coverage factor)  $k = 1,96$  or  $k = 2$  (which provide confidence levels of respectively 95 % and 95,45 % in the case where the distributions characterising the actual measurement uncertainties are normal (Gaussian)). Principles for the calculation of measurement uncertainty are contained in ETSI TR 100 028 [i.9], in particular in Annex D of the ETSI TR 100 028 2 [i.10].

Table 2 is based on such expansion factors.

**Table 2: 5.2 Maximum measurement uncertainty**

Parameter	Uncertainty
<b>Transmitter measurements</b>	
Operating frequency	$\pm 1 \times 10^{-5}$
Transmitter power	$\pm 1$ dB
Out-of-Band emissions	$\pm 4$ dB
Spurious emissions	$\pm 4$ dB
<b>Receiver measurements</b>	
Receiver Selectivity	$\pm 4$ dB

## Radio test suites

### 5.2.1 Transmitter test specification

#### 5.2.1.1 Operating frequency

##### 5.2.1.1 Frequency Accuracy

In order to measure the frequency accuracy for unmodulated pulse radars the measurement is done on the antenna interface. The antenna shall be replaced by a suitable adapter to adapt the rotary joint to a waveguide with a plane flange. On that flange a ~~high power~~ directional coupler will be mounted with its main port terminated by a matching ~~high power~~ dummy load. The coupled port shall have an adequate attenuation within the whole frequency band 8 400 500 MHz to 10 400 000 MHz (at least 400 MHz outside edges of ~~allocated~~ the declared bands) in order to protect the measurement equipment.

~~To measure and display the spectrum of the transmitted signal a suitable spectrum analyser shall be used. The acquisition time for the spectrum shall be at least 60 seconds. The spectrum shall be measured in the maximum hold mode of the spectrum analyser. In this way the deviation of the emission peak frequency from the specified frequency is measured.~~

~~The results obtained shall be compared to the limits in clause 4.2.1.1.2 in order to prove compliance with the requirement.~~

~~To measure the frequency stability a spectrum analyser with a frequency stability of equal or better than  $10^{-5}$  (see Table 2) is connected to the radar transmitter via suitable couplers.~~

When measuring the frequency accuracy for radars with a phase or frequency modulated pulse the accuracy shall be measured on the frequency reference(s) used for generating the radar output signal. If frequency multiplication in the process of generating the output signal is used, then the required frequency accuracy shall be divided by the used multiplication factor.

The transmitter frequency (or the frequency reference(s)) shall be measured using a frequency counter. The test setup for the frequency accuracy measurement can be found in annex B.

##### 5.2.1.2 Transmitter power

The antenna shall be replaced by a suitable adapter to adapt the rotary joint to a waveguide with a plane flange. On that flange a ~~high power~~ directional coupler ~~will be~~ mounted with its main port terminated by a matching ~~high power~~ dummy load. (see figure B.1). The coupled port shall have a sufficient attenuation within the whole frequency band 8 400 500 MHz to 10 400 000 MHz to avoid saturation of the measurement equipment. ~~The coupling factor shall be~~

known in the allocated band with the necessary accuracy to achieve the required transmitter power accuracy of  $\pm 1$  dB (see Table 2).

The radar shall be setup to provide constant maximum output power independently from the azimuth.

Measurement setup shall be as described in annex B.

To determine the Peak Envelope Power (PEP) of the pulse a suitable pulse power meter with direct reading of the transmitter pulse power shall be used.

To reference the indicated transmitter power to the transmitter output flange the coupling factor has to be taken into account.

NOTE: Either the power meter allows already for compensation of the coupling loss, or the coupling loss ~~has to~~ be added to the meter reading.

### 5.2.1.3 Measured Bandwidth

~~The results obtained~~ measurements of the bandwidth ( $B_{40}$  or, for magnetron radars,  $B_{20}$ ) shall be compared to performed with the limits same settings as in clause 4.2.1.2.2 5.2.1.4.

The bandwidth of the emissions 40 dB below PEP (or 20 dB below PEP for magnetron radars) shall be measured. Measurement setup shall be as described in order to prove compliance with the requirement annex B.

### 5.2.1.4 Out-of-Band-emissions

The so-called indirect method as specified in clause 6 of annex 2 of Recommendation ITU-R M.1177-4 [3] shall be applied for the measurement of unwanted emissions of radar systems. At first the transmitter output spectrum is measured with removed antenna at the output port of the transmitter as illustrated in ~~Figure~~ figure B.1.

NOTE 1: ~~To obtain a sufficient dynamic range the radar signal may need to be suppressed by an e.g. additional notch-filter.~~

~~Further information how to perform~~ For multi-frequency and active array radars the measurement can be found in Recommendation ITU R M.1177 4 [2]. The Out-of-Band power emission shall be measured in the frequency bands given in Table 3. The results obtained table 4.

For all other radar systems the Out-of-Band power emission shall be measured in the frequency bands given in table 5.

$B_{40}$  is calculated from the formulae in annex C.

Measurement setup shall be compared to the limits in clause 4.2.1.3.2 and depicted in Figure 2 as described in order to prove compliance with the requirement annex B.

NOTE-2: These OoB-boundaries are taken from ECC/Recommendation (02)05 [1], annex A.

**Table 34: Out-of-Band emissions boundaries for multiple frequency and active arrays**

<u>Lower OoB boundary</u>	<u>Upper OoB boundary</u>
<u>Centre frequency <math>-2,3 \times B_{40}</math></u>	<u>Centre frequency <math>+2,3 \times B_{40}</math></u>
<u>NOTE 1: The values are taken from ECC Recommendation (02)05 [1].</u>	
<u>NOTE 2: Measurements below the waveguide cut-off frequency are not necessary.</u>	

**Table 5: Out-of-Band emissions boundaries for all other radar systems**

<u>Lower OoB boundary</u>	<u>Upper OoB boundary</u>
<u>Carrier frequency <math>-15,8 \times B_{40}</math></u>	<u>Carrier frequency <math>+15,8 \times B_{40}</math></u>
<u>NOTE 1: The values are taken from ECC Recommendation (02)05 [1].</u>	
<u>NOTE 2: Measurements below the waveguide cut-off frequency are not necessary.</u>	

~~NOTE 3: Typical parameters are e.g. a centre frequency of 9,1 GHz, a pulse duration of  $t = 50$  ns and a rise time of  $t_r = 10$  ns, the 40 dB bandwidth calculated applying the equation from clause 4.2.1.1.1 is 340 MHz. This leads to OoB boundaries at  $15,8 \times 340$  MHz = 5,372 GHz away from the centre frequency (Figure 4). For this example the absolute boundaries between out of band emission and spurious emission are:  $9,1$  GHz  $- 5,372$  GHz = 3,728 GHz and  $9,1$  GHz  $+ 5,372$  GHz = 14,472 GHz (see Figure 5 below).~~

All measurements of Out-of-Band emissions shall be made with a reference bandwidth of 1 MHz.

Figures ~~45~~ and ~~56~~ depict the calculated emission masks for the aforementioned parameters of a typical radar applying the mask specification in clause ~~4.2.1.3~~ 4.2.1.4 which is corresponding to the standard mask in ~~Figure~~ figure A2.1c of ECC/Recommendation (02)05 [1].

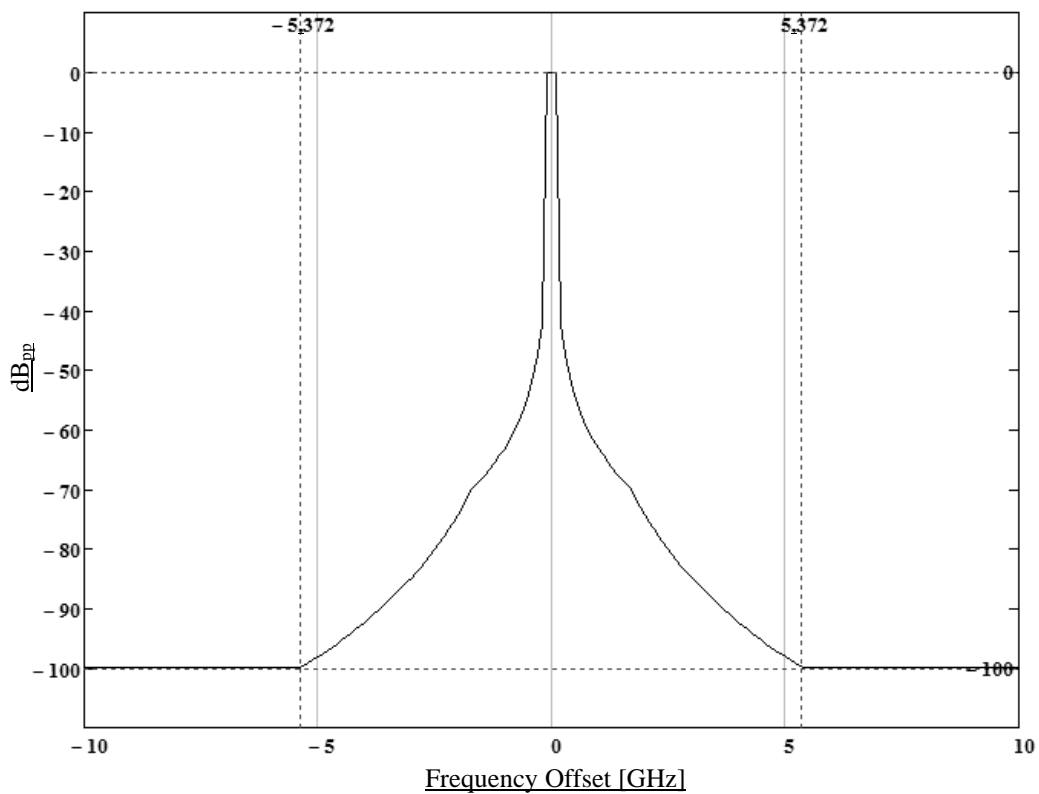
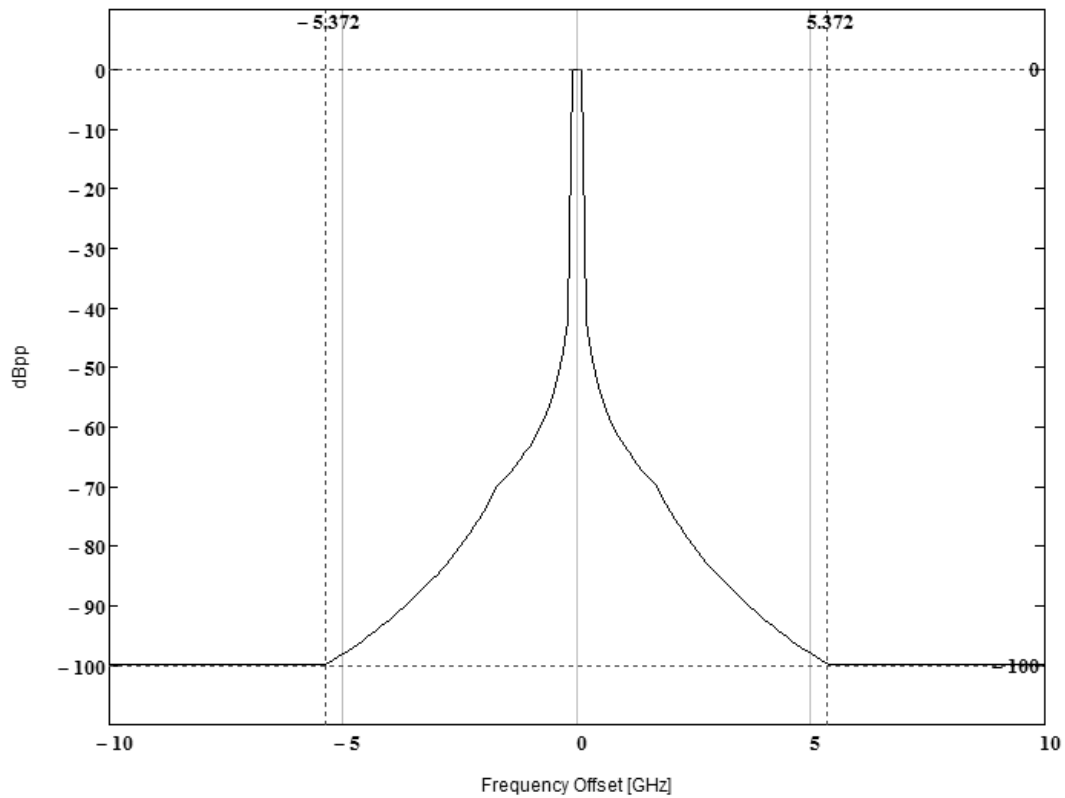
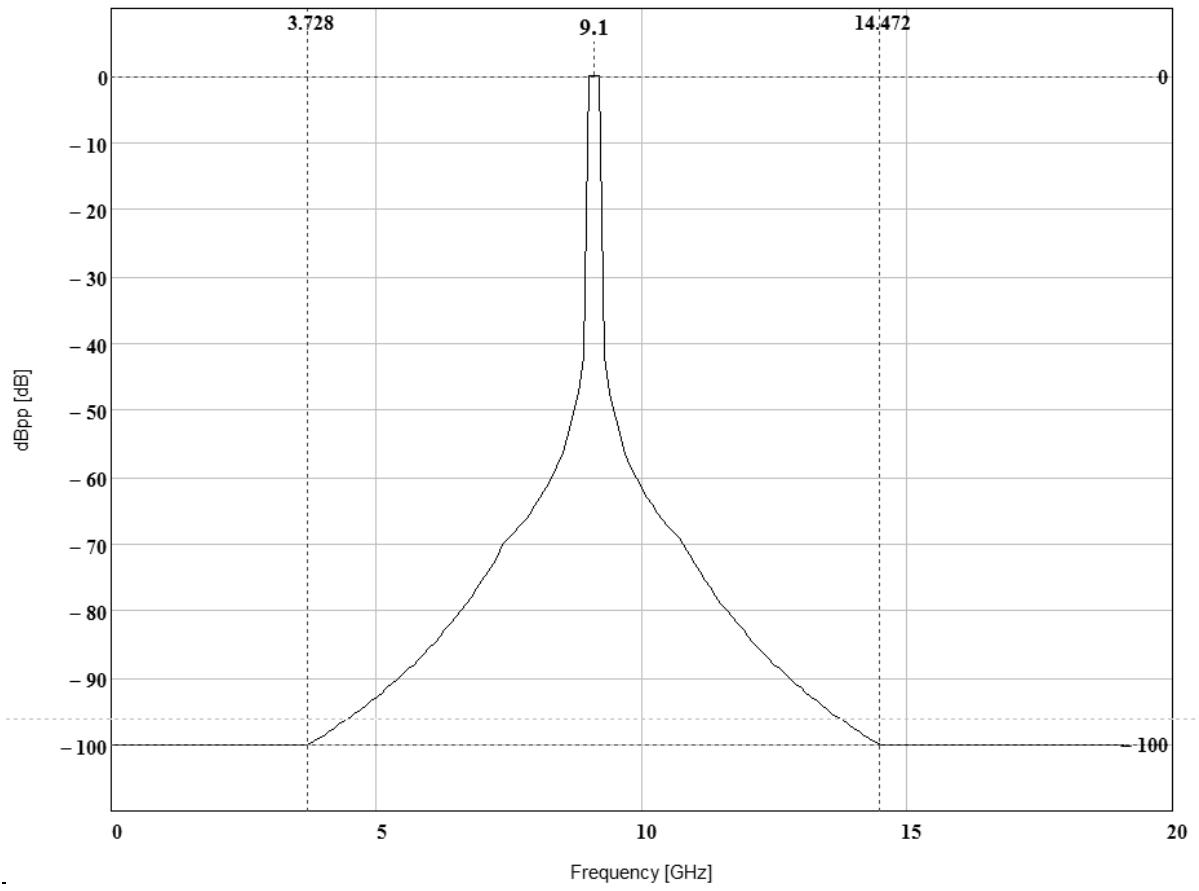
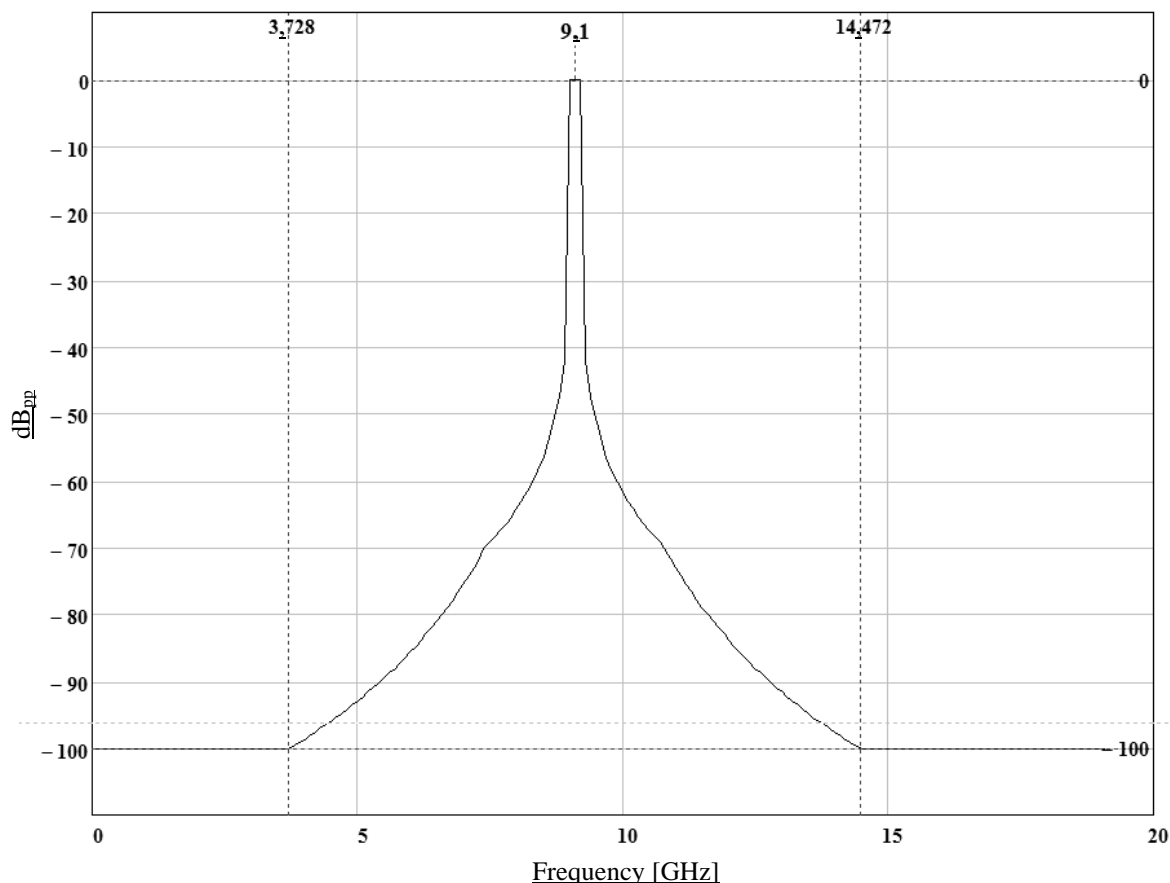

Figure 4: ~~Theoretical emissions~~ 5: Calculated emission mask for typical pulse duration of  $t = 50$  ns and rise time of  $t_r = 10$  ns





**Figure 5-6:** Calculated emissions mask for pulse duration of  $t = 50$  ns and rise time of  $t_r = 10$  ns at centre frequency of 9,1 GHz

### 5.2.1.5 Spurious emissions

For the spurious emission measurements the aforementioned indirect method specified in clause 6 of annex 2 of Recommendation ITU-R M.1177-4 [3] shall be used. ~~To perform the measurement the radar and the measuring equipment~~ Measurement setup shall be installed as displayed described in Figure-figure B.1. A combination of WR112/R84 taper section and a WR90/WG16/R100 Waveguide as defined in IEC 60153-2 [i.3] shall be used. This makes it possible to measure down to at least the WaveGuide cut-off frequency 6,56 GHz. The spurious power ~~emissions~~ emissions shall be measured in the frequency ranges outside the Out-of-Band emissions boundaries as indicated in table 6.

If required to reach a dynamic amplitude measuring range of 110 dB minimum, a Low Noise Amplifier (LNA), and a notch filter for the operating frequency should be used.

~~The results obtained shall be compared to the limits in clause 4.2.1.4.2 in order to prove compliance with the requirement.~~

Since the lower measurement frequency is 6,56 GHz (cut-off frequency), all measurements of spurious emissions shall be made with a reference bandwidth of 1 MHz.

**Table 3a-6: Spurious emissions measurement bands (active and stand-by mode)**

Lower measurement band	Upper measurement band
From 6,56 GHz to the lower OoB boundary	From the upper OoB boundary to 26 GHz
NOTE 1: 6,56 GHz is the cut-off frequency of the combination of WR112/R84 taper section and a WR90/WG16/R100 Waveguide.	
NOTE 2: 26 GHz is the upper limit for measurement of unwanted emissions as indicated in table 1 of ERC Recommendation 74-01 [2].	
NOTE 3: OoB boundaries are defined in table 4 for multiple frequency and active arrays and in table 5 for all other radar systems.	

## 5.2.2 Receiver test specification

### 5.2.2.1 Receiver Selectivity

These measurements shall be performed under normal test conditions.

#### Compliance is tested 5.2.1.6 Stand-by by subjecting the receiver input to signals at any frequency within Mode Emissions

For the spurious domain, the receiver selectivity shall then be verified at a practical number of emission measurements the aforementioned indirect method specified in clause 6 of annex 2 of Recommendation ITU-R M.1177-4 [3] shall be used. To perform the measurement points (at least 8), the radar and the measuring equipment shall be installed as shown in figure B.1 and be placed in stand-by mode but still powered on. A combination of WR112/R84 taper section and a WR90/WG16/R100 Waveguide as defined in IEC 60153-2 [i.3] shall be used. This makes it possible to measure down to at least the WaveGuide cut-off frequency 6,56 GHz. RF emissions from the radar are not possible below this frequency.

The manufacturer shall justify that the tested frequencies covers potential spurious responses of the receiver.

In the test setup a WR112/R84 Waveguide taper section power emissions in standby mode shall be connected to the regular WR90/R100 Waveguide measured in frequency ranges outside the Out-of-Band emissions boundaries as indicated in table 6.

NOTE: In this way Since the lower measurement setup is able to cover the cut off frequency, otherwise the measurement setup will itself be "blind" near the is 6,56 GHz (cut-off frequency. With), all measurements of spurious emissions shall be made with a reference bandwidth of 1 MHz.

Measurement setup shall be as described in figure B.1.

## 5.2.2 Receiver test specification

### 5.2.2.1 System Noise Figure

#### 5.2.2.1.0 General

The system noise figure is measured along the complete receiving signal chain (as close as possible, including quantization noise, but excluding antenna & installation waveguide, and noise processing). It shall be measured using a noise source over the taper section operating band.

The required measurement method for the cut-off System Noise Figure is lowered the Y-factor method. A noise source is connected in lieu of the antenna to the radar receiver input port. The System Noise Figure is then determined from the ratio between the noise power values at output of the intermediate frequency stage (or its digitized equivalent taken from a PPI display) with noise source on and noise source off.

Suitable precautions and instrumentation choice are required to minimize the gain error when measuring the noise figure of the receiver, i.e. 6,56 GHz changes in source impedance between states of the noise source reacting with a non-zero  $S_{11}$  of the receiver input:

$$\text{Gain error} = (1 - S_{11}\Gamma_{\text{on}})^2 / (1 - S_{11}\Gamma_{\text{off}})^2 \quad (1)$$

The test setup for the noise figure measurement can be found in annex F.

## 5.2.2.2 Receiver Selectivity

### 5.2.2.2.0 General

For modern solid state digital radars the emitted signals may be very complicated and include both phase-modulation, frequency-hopping and -sweeping and pulse width modulation. This makes a single definition of MDS and interfering signal difficult. The following is a generalized approach based upon a calculated MDS value:

$$MDS = kT_0 B_{res} NF_{sys} D_{nospur} \frac{1}{T_C B_C} M \quad (2)$$

Where:

MDS Minimum Detectable Signal

k Boltzmann constant

T<sub>0</sub> Temperature in Kelvin

B<sub>res</sub> 3 dB resolution bandwidth of transceiver

N<sub>f,sys</sub> Noise Factor of the system

D<sub>no spur</sub> Detectability Factor (function of P<sub>D</sub> & P<sub>fa</sub>) = 0,03 (-15 dB)

**NOTE:** The detectability factor is the signal to noise ratio between the disturbance and a real target. The value of 0,03 (-15 dB) for D<sub>no spur</sub> is taken from figure 2.3 of "Radar Handbook" [i.2].

P<sub>D</sub> Probability of detection = 10<sup>-3</sup> (selected value)

P<sub>FA</sub> Probability of false detection = 10<sup>-3</sup> (selected value)

T<sub>C</sub> Pulse length (of individual chirp) in seconds

B<sub>C</sub> Effective bandwidth of receiver

M Test margin = 0,1 (Without this margin the receiver should give a detectable signal)

The factor 1/(T<sub>C</sub> B<sub>C</sub>) will be equal to 1 for a single frequency radar using only pulse width modulation.

### 5.2.2.2.1 Receiver Out-of-Band selectivity

In order to determine if the receiver selectivity follows the required mask, a disturbance test signal level at MDS level plus the required attenuation shall be applied at the antenna flange.

#### **Disturbing Test Signal**

The disturbance signal shall be a sinusoidal pulsed signal with pulse duration of 100 ns and a pulse repetition frequency of 1 kHz. The radar shall be set up with a pulse repetition frequency of other than 1 kHz during the measurements. The rise/fall time of the disturbance signal shall be maximum 10 ns.

#### **Maximum Level of Disturbing Signal**

The radar video maximum level of the disturbing signal shall be selected such that the receiver is not show any "saturated. The selected test signal level shall be 6 dB below compression level for the given receiver design. The maximum disturbing signal input to the receiver shall not exceed -30 dBm.

#### **Roll off of Disturbing Test Signal**

From each edge of B<sub>40</sub> the signal strength shall increase from MDS level by 30 dB per decade to 70 dB above MDS level. This is illustrated in figure 7 below.



### Test Pass Criteria

The requirement is that the disturbing test signal shall not result in detection of false targets" at any of the \_ with a higher probability than  $10^{-3}$ .

### Measurement Points

The selected disturbance test signal shall be swept over a frequency span of the Out of Band domain. Manufacturer shall ensure that the swept frequency span encompasses all image frequencies present in the OoB domain/region. The spurious domain is not checked since it is unlikely that the receiver is sensitive that far from the used band.

The interspacing between measurement points. The \_ shall be selected to be less than half the system resolution bandwidth (3 dB bandwidth of the processed radar output). This should ensure that all possible disturbance frequencies are covered.

### The Case of Multi-Frequency and/or Chirping Radars

In case a radar makes use of multiple frequencies and/or chirps the effective  $B_{40}$  where full sensitivity is allowed may be taken as the joined envelope of all frequencies used; provided the frequencies are adjacent.

If frequencies are not adjacent, a separate  $B_{40}$  is used for each frequency where full sensitivity is allowed.

The test setup for the receiver selectivity test can be found in annex G.

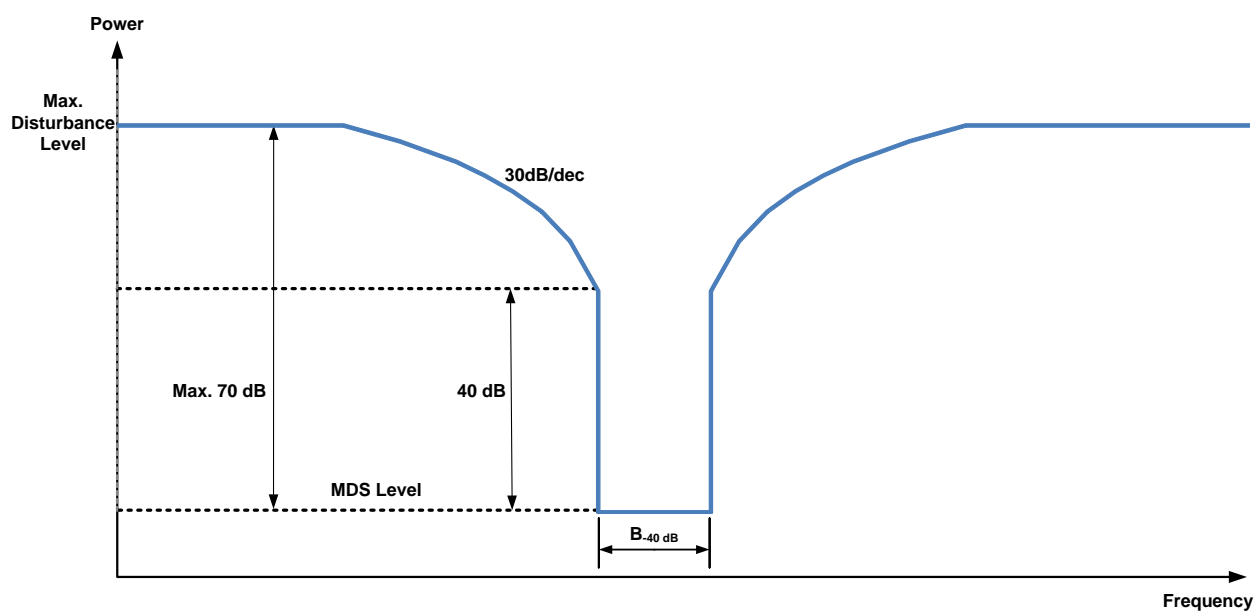

**Figure 7: Resulting receiver selectivity mask (not to scale)**

#### 5.2.2.3 Receiver Compression Level

The test setup for the receiver compression level test can be found in annex G.

The radar transmitter shall be placed in stand-by mode.

For the measurement of the compression level, using a RF signal generator, the test signal shall be applied to the waveguide input of the transceiver is setup in normal operating mode during the test through a Coaxial/WG transition.

The test signal shall be selected so that it passes through the receiver. Depending on the kind of receiver, a CW or pulsed test signal shall be used.

The gain response curve of the receiver input amplifier (LNA) shall be measured and the 1 dB compression point shall be noted.

## Annex A (normative/informative): Relationship between the present document and the essential requirements of Directive 2014/53/EU

The present document has been prepared under the Commission's standardisation request C(2015) 5376 final [i.12.6] to provide one voluntary means of conforming to the essential requirements of Directive 2014/53/EU on the harmonisation of the laws of the Member States relating to the making available on the market of radio equipment and repealing Directive 1999/5/EC [i.1].

Once the present document is cited in the Official Journal of the European Union under that Directive, compliance with the normative clauses of the present document given in ~~Table~~ table A.1 confers, within the limits of the scope of the present document, a presumption of conformity with the corresponding essential requirements of that Directive, and associated EFTA regulations.

**Table A.1: Relationship between the present document and the essential requirements of Directive 2014/53/EU**

Harmonised Standard ETSI EN 303-135					
The following requirements are relevant to the presumption of conformity under the article 3.2 of Directive 2014/53/EU [i.1]					
Requirement				Requirement Conditionality	
No	Description	<u>Essential requirements of Directive</u>	<u>Reference- Clause No(s) of the present document</u>	U/C	Condition
1	<del>Operating frequency</del> <u>Frequency Accuracy</u>	<u>3.2</u>	<u>4.2.1.1</u>	U	
2	Transmitter power	<u>3.2</u>	<u>4.2.1.2</u>	U	
3	<u>Measured bandwidth</u>	<u>3.2</u>	<u>4.2.1.3</u>	U	
<del>34</del>	Out-of-Band emissions	<u>3.2</u>	<u>4.2.1.34</u>	U	
45	Spurious emissions	<u>3.2</u>	<u>4.2.1.45</u>	U	
6	Stand-By Mode Emissions	<u>3.2</u>	<u>4.2.1.6</u>	U	
7	System Noise Figure	<u>3.2</u>	<u>4.2.2.1</u>	U	
<del>58</del>	Receiver Selectivity	<u>3.2</u>	<u>4.2.2.42</u>	U	
9	Receiver Compression Level	<u>3.2</u>	<u>4.2.2.3</u>	U	

### Key to columns:

#### Requirement:

**No** A unique identifier for one row of the table which may be used to identify a requirement.

**Description** A textual reference to the requirement.

#### Essential requirements of Directive

\_\_\_\_\_ Identification of article(s) defining the requirement in the Directive.

#### Clause Number(s) of the present document

\_\_\_\_\_ Identification of clause(s) defining the requirement in the present document unless another document is referenced explicitly.

#### Requirement Conditionality:

**U/C** Indicates whether the requirement ~~shall be~~ is unconditionally applicable (U) or is conditional upon the ~~manufacturer's~~ manufacturer's claimed functionality of the equipment (C).

**Condition** Explains the conditions when the requirement ~~shall~~ is or ~~shall not be~~ is not applicable for a requirement which is classified "conditional".

Presumption of conformity stays valid only as long as a reference to the present document is maintained in the list published in the Official Journal of the European Union. Users of the present document should consult frequently the latest list published in the Official Journal of the European Union.

Other Union legislation may be applicable to the product(s) falling within the scope of the present document.

## Annex B (normative): Transmission power, Frequency Accuracy and unwanted emissions Unwanted Emissions of radar systems with indirect methods

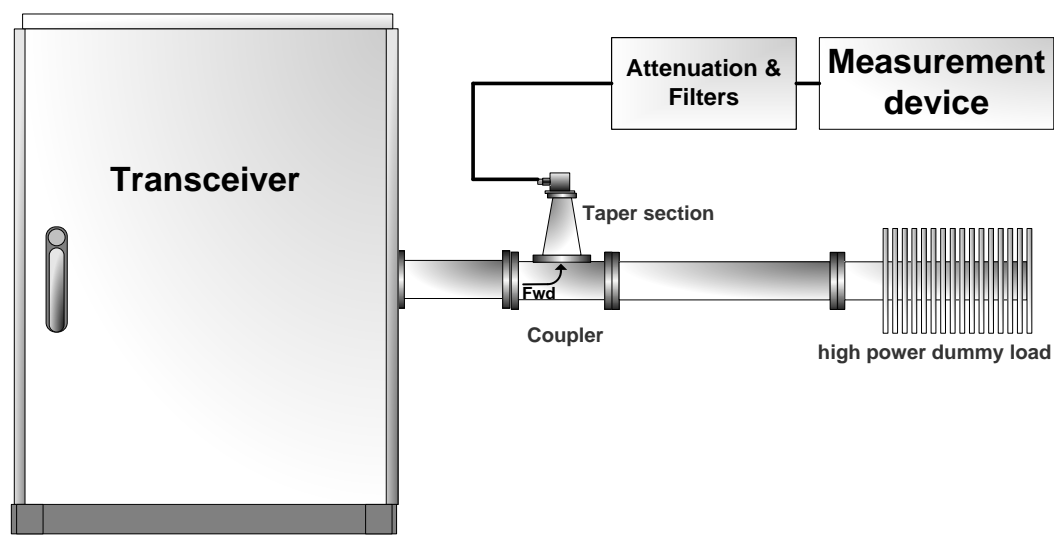
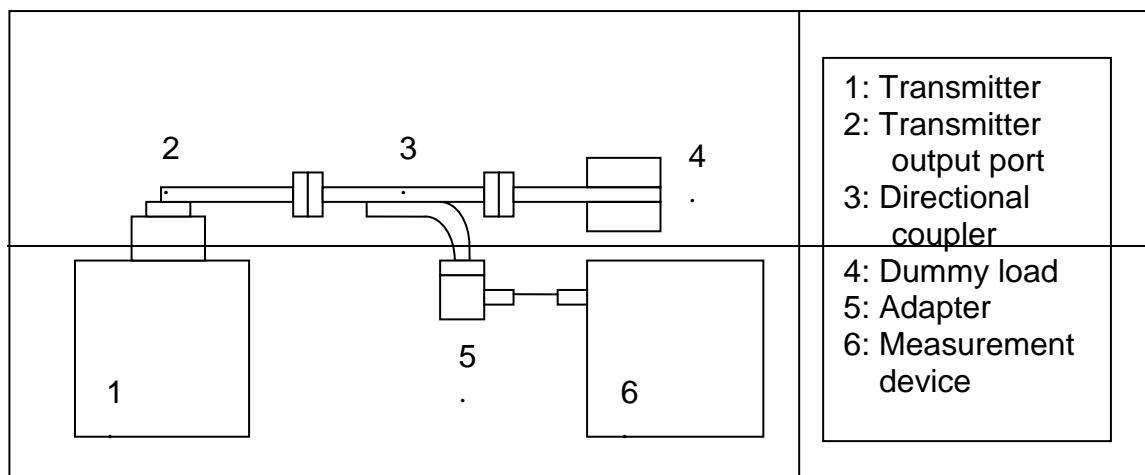

**Figure B-4-1: Indirect method for radio frequency measurements with dismounted antenna**

The method for measurement of the operation frequency, transmit power as well as out-of-band and spurious emission shown in Figure B.1 shall be applied. figure B.1 shall be applied. The Taper section shall be WR112/R84 and the waveguide shall be WR90/WG16/R100 as defined by IEC 60153-2 [i.3].

Since transceiver and antenna are hollow metallic rectangular waveguide based on the frequency range for measurements that needs to be addressed covers 6.56 GHz to 26 GHz. The lower limit of this frequency range is obtained as cut-off frequency of the combination of WR112/R84 taper section and a WR90/WG16/R100 Waveguide as defined in IEC 60153-2 [i.3]. The upper limit corresponds to the upper limit stated in ERC Recommendation 74 01 [2].

---

## Annex C (normative): Calculation of the -40 dB Bandwidth

Annex 8 of Recommendation ITU-R SM.1541-6 [i.5] specifies the -40 dB bandwidth for various types of waveforms (e.g. pulsed radar signals).

Annex C With the following assumptions which apply to most VTS/CS radars these specifications can be further simplified:

- the radar is operating in the band 8 500 MHz to 10 000 MHz;
- the pulse power is below 100 kW (at the transmitter output);
- the pulse rise time  $t_r$  is greater than  $0,0094 \times t$ , where  $t$  is the pulse duration.

With the aforementioned assumptions the -40 dB bandwidth ( $B_{-40}$ ) for primary non-FM pulse radars can be determined as follows:

$$B_{-40} = \frac{7,6}{\sqrt{t \times t_r}} \quad \text{(C.1)}$$

Where:

- $t$  is the pulse duration.
- $t_r$  is the rise time in the case of a trapezoidal pulse.

For frequency modulated pulse radar systems the -40 dB bandwidth is:

$$B_{-40} = 1,5 \{ B_C + \sqrt{\pi} \times [\ln(B_C \times \tau)]^{0,53} \times [\text{Min}(B_{rise}, B_{fall}, B_{rise\&fall}) + \text{Max}(B_{rise}, B_{fall}, B_{rise\&fall})] \} \quad \text{(C.2)}$$

Where:

- $B_C$  is the bandwidth of the frequency deviation (total frequency shift during the pulse generation).
- $\tau$  is the pulse length including rise and fall times.
- $B_{rise} = \frac{1}{\sqrt{t_r \times t_r}}$  to account for the rise time.
- $B_{fall} = \frac{1}{\sqrt{t_f \times t_f}}$  to account for the fall time.
- $B_{rise\&fall} = \frac{1}{\sqrt[3]{t_r \times t_r \times t_f}}$  to account for both the rise and fall times combination.
- $t_r$  is the rise time.
- $t_f$  is the fall time.

The equation 2 above is only valid when the following conditions are met:

- 1) the product  $B_C \times \text{Minimum}(t_r, t_f)$  is greater than or equal to 0,10 and
- 2) that the product of  $B_C \times \tau$  or compression ratio is greater than 10.

In all other cases, the following equations shall be used:

$$B_{-40} = \frac{K}{\sqrt{t \times t_r}} + 2 \left( B_C + \frac{A}{t_r} \right) \quad \text{(C.3)}$$

Where:

- K is a coefficient related to the output power of the radar and is 7,6 for radars with output power below 100 kW.
- A is 0,065 when K = 7,6.

NOTE: The term  $A/t_r$  adjusts the value of  $B_{-40}$  to account for the influence of the rise time, which is substantial when the time-bandwidth product  $B_C \times t$ , is small or moderate and the rise time is short.

For radars with an asymmetrical spectrum (e.g. magnetron based radars), the  $B_{-40}$  dB bandwidth can be offset from the frequency of maximum emission level, but the necessary bandwidth,  $B_N$  and preferably the overall occupied bandwidth should be contained completely within the declared band as stipulated in section 4 of annex 8 of Recommendation ITU-R SM.1541-6 [i.5].

The application of this rule is illustrated in figure C.1.

For radars with multiple pulse waveforms, the  $B_{-40}$  bandwidth shall be calculated for each individual pulse and the largest  $B_{-40}$  bandwidth shall be used.

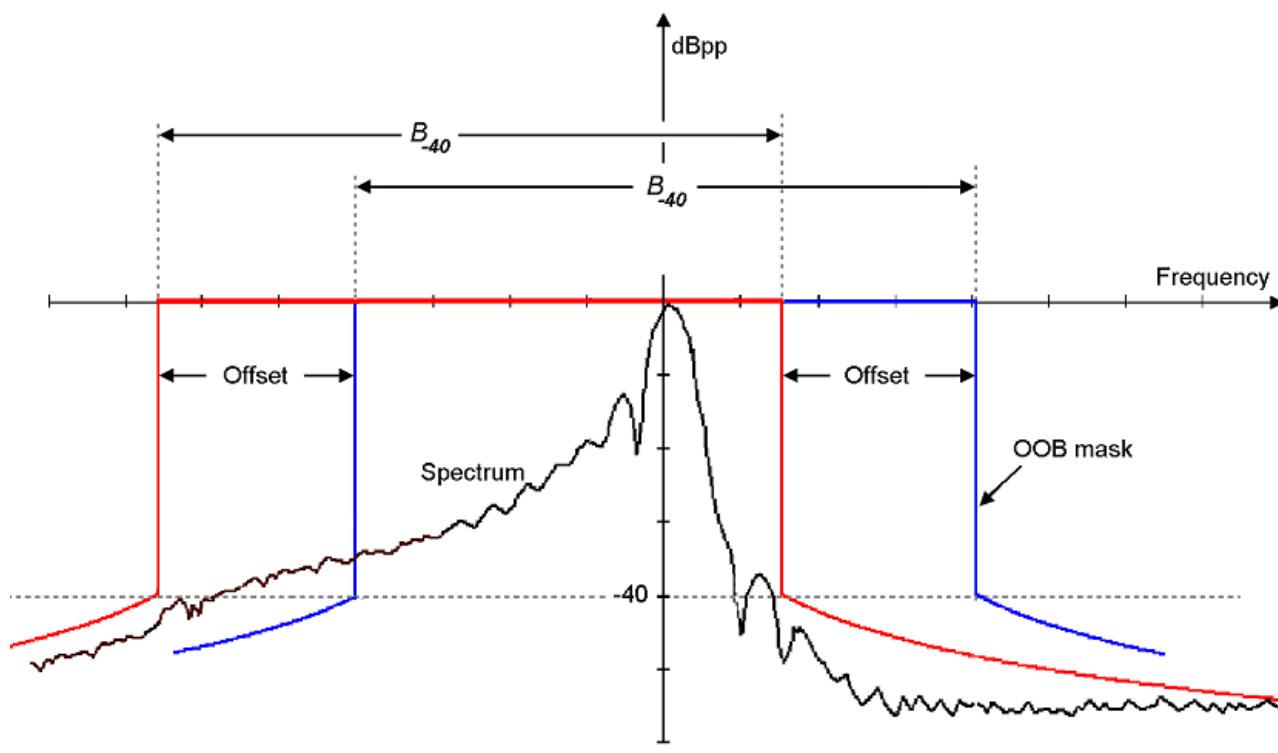

**Figure C.1: Application of the offset-rule for the Out-of-Band emission limit mask**



## Annex D (informative): Maximum Measurement Uncertainty

The measurements described in the present document are based on the following assumptions:

- the measured value related to the corresponding limit is used to decide whether an equipment meets the requirements of the present document;
- the value of the measurement uncertainty for the measurement of each parameter is included in the test report.

Table D.1 shows the recommended values for the maximum measurement uncertainty figures.

**Table D.1: Maximum measurement uncertainty**

<u>Parameter</u>	<u>Uncertainty</u>
<b><u>Environment measurements</u></b>	
Temperature	1 °C
Relative Humidity	5 %
<b><u>Transmitter measurements</u></b>	
Operating frequency	±1 ppm
Transmitter power	±1,5 dB
Out-of-Band emissions	±4 dB (see note 1)
Spurious emissions	±4 dB (see note 1)
Mains Supply Voltage	0,1 %
<b><u>Receiver measurements</u></b>	
System Noise Figure	±1 dB
Receiver Selectivity	±4 dB (see note 2)
NOTE 1: Between 0 and -30 dBc for CW signals. These radar systems use very complicated waveforms using pulse length modulation, frequency hopping, unlinear frequency chirping or phase coding. A frequency analyser is specified to sinusoid signals and for high dynamic ranges is only specified for accuracy in the top most 30 dB of its dynamic range. Therefore the actual accuracy that can be achieved during such measurements up to 100 dB below PEP at 26 GHz power is no better than ±4 dB.	
NOTE 2: Between 0 and -20 dBm.	

## Annex E (informative): WR90/WG16/R100 waveguide characteristics

The cut-off frequency ( $TE_{10}$ ) of a WR90/WG16/R100 waveguide is 6 556 MHz. EM Fields below this frequency will not propagate through the waveguide, corresponding to a fast exponential decrease of the fields. The theoretical waveguide loss inside a waveguide will behave asymptotical at the cut off frequency as shown in figure E.1.

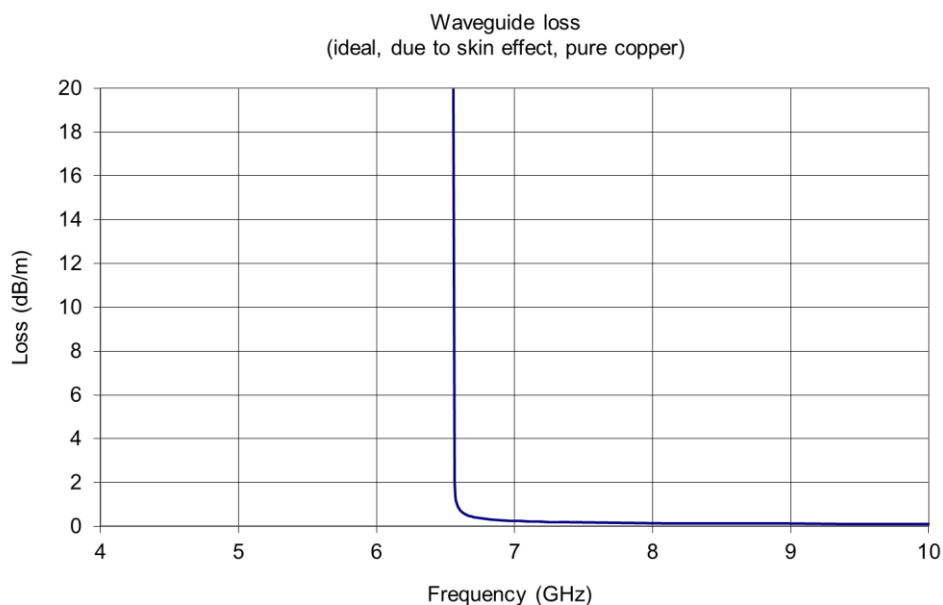

**Figure E.1: Attenuation for an ideal waveguide**

This is also confirmed by a practical measurement. As shown in figure E.2, the measurement of a 40 cm long WR90/WG16/R100 waveguide (with flanges) has produced an attenuation of at least 110 dB below the cut-off frequency. Since what is shown on the left side of figure E.2 represents noise (thermal noise and the noise floor of the measurement instrument) the real attenuation below the cut-off frequency is greater than 110 dB. The following has to be pointed out:

- 1) An attenuation of 110 dB below PEP is already sufficient to fulfil the unwanted emission requirement specified in table 15 of ERC Recommendation 74-01 [2].
- 2) A radar system can have several meters of waveguide between the transmitter and the antenna resulting in a still higher attenuation of the emissions below the cut-off frequency.

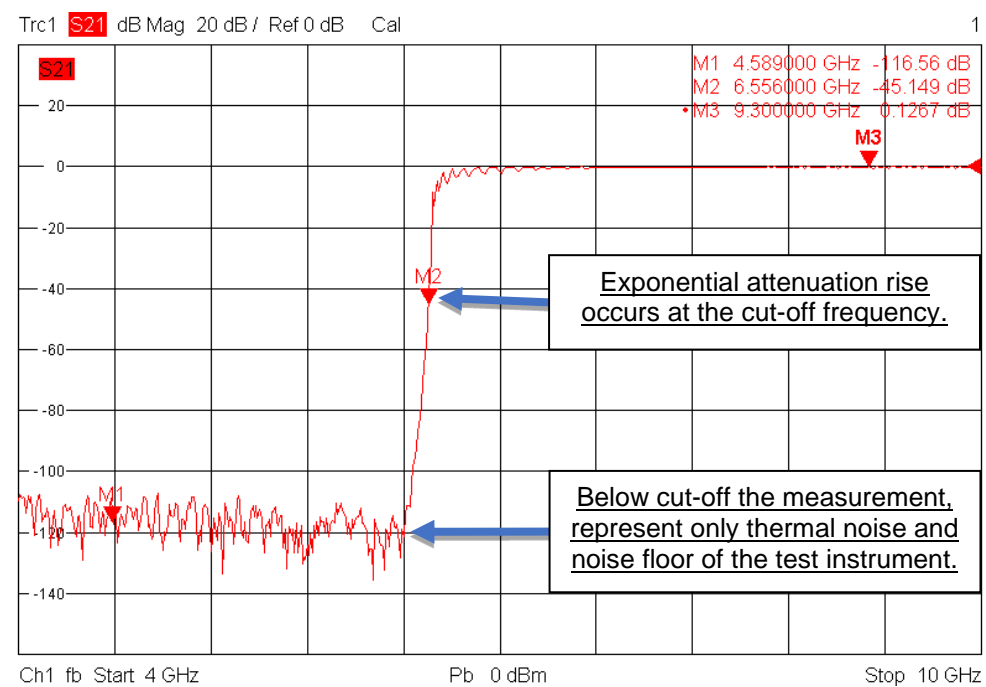

**Figure E.2: Measured waveguide attenuation for a length of 40 cm**

It can therefore be inferred that:

- An X-Band CS/VTS/HR radar using waveguide transmission lines to the antenna is not able to transmit any disturbances below the cut-off frequency and so cause harmful interference. The emissions below cut-off will be immeasurably low due to the strong attenuation of EM fields below the cut-off frequency.
- Any emissions below the cut-off frequency produced by the transmitter cannot be conducted to the test equipment, and so cannot even be measured.

All things considered and following a conservative approach it can be concluded that measurements below the cut-off frequency of the waveguide are not necessary when the undisturbed length of the waveguide is at least 20 wavelengths of the cut-off frequency (92 cm for a WR90/WG16/R100 waveguide).

## Annex F (normative): Noise figure measurement set-up

The test setup for the measurement of the noise figure measurement of the transceiver shown in figure F.1 shall be applied.

For the measurement of the noise figure, the noise level shall be applied using a calibrated noise source connected to the waveguide input of the transceiver through a Coaxial/WG transition and measurements shall be performed at the IF output of the receiver (if possible) or at the PPI output.

The video processing of the transceiver shall be disabled. The receiver shall be shielded as best possible against all other inputs than the noise source (e.g. by terminating circulator output towards the transmitter/RF amplifier).

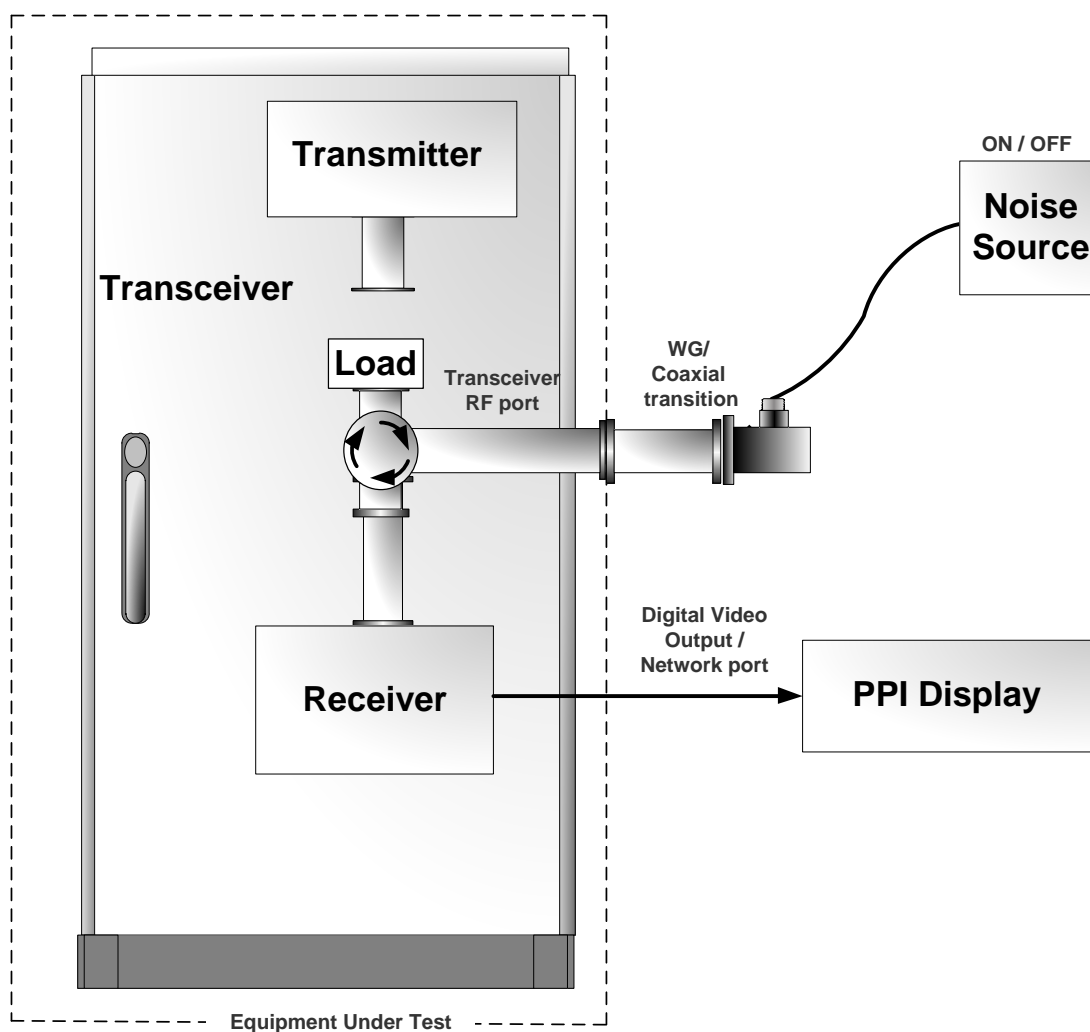

**Figure F.1: Method for Noise Figure measurement of the transceiver**

## Annex G (normative): Compression level and selectivity measurement set-up

The test setup for the measurements of the compression level and the receiver selectivity of the transceiver shown in figure G.1 shall be applied.

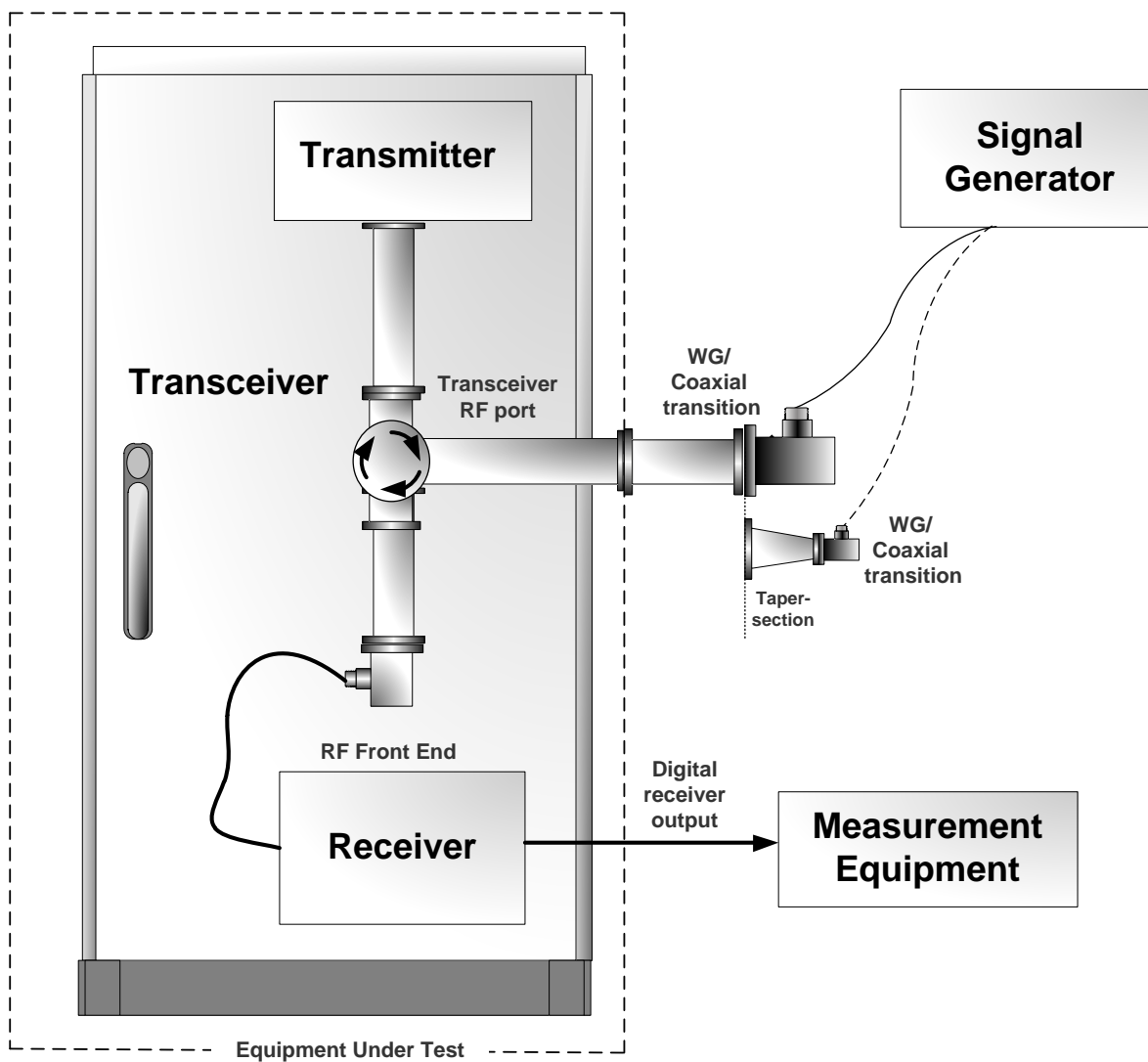

**Figure G.1: Method for compression level and selectivity measurements of the transceiver**

## Annex H (informative): Checklist

This annex provides a traceability of the technical parameters for article 3.2 of Directive 2014/53/EU [i.1] defined in ETSI EG 203 336 [i.4] with the technical requirements for conformance defined in clause 4 of the present document. If a technical parameter for article 3.2 of Directive 2014/53/EU [i.1] defined in ETSI EG 203 336 [i.4] has not been included in the present document, an explanation is provided. An explanation is also provided whenever a technical parameter defined in ETSI EG 203 336 [i.4] is covered by an alternative technical requirement.

Some technical parameters defined in ETSI EG 203 336 [i.4] are applicable only to communication systems and not to non-cooperative radar systems such as coastal surveillance radar systems. Non-cooperative radar systems are different from radiocommunication systems since they do not communicate with a known target with known properties. They continually scan for unknown targets of any nature and do not adjust receiver or transmitter parameters according to what they detect.

**Table H.1**

<u>Technical Parameters defined in ETSI EG 203 336 [i.4]</u>	<u>Clauses of the present document</u>	<u>Comments</u>
<b>Transmitter Parameters</b>		
<u>Transmit power (and possible accuracy)</u>	<u>4.2.1.2</u>	
<u>Spectrum mask</u>	<u>4.2.1.4</u>	
<u>Transmitter Frequency stability</u>	<u>4.2.1.1</u>	
<u>Transmitter Intermodulation attenuation</u>	<u>NA</u>	<u>ETSI EG 203 336 [i.4] states that this parameter shall be considered for base stations with shared sites and dense usage scenarios. The requirement is not meant for radars. Especially the high directivity of antennas and the rotating of the antenna used for this application prevents intermodulation from becoming more than an occasional non-correlating issue that is easily filtered by processing algorithms. As radars are not standardized products, and the topology for a radar varies very much per manufacturer, it is impossible for the present document to direct specific measurements on the "unknown" design.</u>
<u>Unwanted emissions (OOB and spurious domains)</u>	<u>4.2.1.4</u> <u>4.2.1.5</u>	
<u>Transmitter Time domain characteristics (e.g. e.g. the duty cycle, turn-on and turn-off, frequency hopping cycle, dynamic changes of modulation scheme and others)</u>	<u>NA</u>	<u>The time domain characteristics for the radars in the present document are ruled by physical restrictions and design properties. They cannot be specified generally for the whole range of possible radar designs. Radars in this application are designed for sharing the exact same frequencies without any coordination or synchronization between systems regarding sharing. This is possible due to rotating high directivity antennas, pulsed and staggered transmission schemes, multi-frequency usage, gating of receiver, digital processing, coding of signal emissions, not-co-siting, etc.</u>
<u>Transmitter Transients</u>	<u>NA</u>	<u>This requirement is not meant for radars. The present document assumes pulsed radar transmissions. It is in the nature of such radars to have a very high degree of control on the emitted pulses because otherwise the resulting output video quality would be negatively affected. There are no turn-on/turn-off transients.</u>

<u>Technical Parameters defined in ETSI EG 203 336 [i.4]</u>	<u>Clauses of the present document</u>	<u>Comments</u>
<b>Receiver Parameters</b>		
<u>Receiver sensitivity</u>	<u>4.2.2.1</u>	<u>This parameter is not explicitly included since the radar output power is not varied as a result of the received signal strength of a single target, which means that a better sensitivity will only affect the probability of detection and does not affect the efficient use of the radio spectrum. However, the noise figure is included.</u>
<u>Receiver co-channel rejection</u>	<u>NA</u>	<u>This requirement is not meant for radars. Radars in this application are designed for sharing the exact same frequencies without any coordination between systems regarding sharing. This is possible due to rotating high directivity antennas, pulsed and staggered transmission schemes, gating of receiver, multi-frequency usage, digital processing, coding of signal emissions, not-co-siting, etc.</u>
<u>Adjacent channel/band Selectivity</u>	<u>4.2.2.2</u>	<u>A radar receiver is by nature very sensitive. Signals in an adjacent band are usually also present in dampened form inside the intended band of the radar receiver, and even with the required roll-off of sensitivity the receiver has some ability of receiving in the adjacent bands. This means that a radar has to be able to cope not only with other users in the same band but also with some dampened form of signals from adjacent bands. This is again possible due to rotating high directivity antennas, pulsed and staggered transmission schemes, gating of receiver, multi-frequency usage, digital processing, coding of signal emissions, not-co-siting, etc. The selectivity test defined in clause 5.2.2.2 covers this scenario.</u>
<u>Spurious response Rejection</u>	<u>4.2.2.2</u>	<u>The selectivity test defined in clause 5.2.2.2 also covers image and intermediate frequencies.</u>
<u>Receiver blocking</u>	<u>4.2.2.3</u>	<u>Receiver Blocking is addressed by requiring a sufficiently high compression level in the receiver. The receiver compression level test defined in clause 5.2.2.3 specifies an adequately high level of signal handling capability. In a radar design this has to be weighed against the performance requirement of detecting very low signals, and the possible dynamic range. The disturbance signal levels in the selectivity measurements defined in clause 5.2.2.2 are chosen to follow the curve of highest possible disturbance rejection.</u>
<u>Receiver radio-frequency intermodulation</u>	<u>NA</u>	<u>Due to rotating high directivity antennas, pulsed and staggered transmission schemes, gating of receiver, multi-frequency usage, digital processing, coding of signal emissions, not-co-siting, etc. this is not considered to be an actual issue in modern radar receivers.</u>
<u>Receiver dynamic range</u>	<u>NA</u>	<u>The required dynamic range of the receiver varies by topology of the individual radar system (again radars are not standardized between manufacturers). It is clearly an important performance parameter of a radar in order to detect required large and small targets at near and far ranges, and as such it is covered by the relevant performance standard.</u>

<u>Technical Parameters defined in ETSI EG 203 336 [i.4]</u>	<u>Clauses of the present document</u>	<u>Comments</u>
<u>Reciprocal mixing</u>	NA	<p>In this band and usage there are basically two types of radar:</p> <ol style="list-style-type: none"> <li>1) <u>Coherent (usually pulse compression) systems where phase noise is a very important performance parameter and as such is covered by performance requirement standards.</u></li> <li>2) <u>Traditional magnetron based simple pulsed radars where the LO tracks the magnetron frequency in order to compensate for the magnetron drifting in frequency over time.</u></li> </ol> <p><u>For these systems there will not be an increased efficiency of spectrum usage by defining a measurement of phase noise effects. Moreover specifying a generic measurement while not knowing the topology of the system under test is impossible.</u></p>
<u>Desensitization</u>	4.2.2.3	It is included by requiring a sufficiently high compression level of the receiver.
<u>Receiver unwanted emissions in the spurious domain</u>	4.2.1.6	



---

## Annex I (informative): Bibliography

- Recommendation ITU-R SM.328-11: "Spectra and bandwidth of emissions".
- Recommendation ITU-R SM.329-4012: "Unwanted emissions in the spurious domain".
- ETSI TR 102 273 (all parts) (V1.2.1) (12-2001): "Electromagnetic compatibility and Radio spectrum Matters (ERM); Improvement on Radiated Methods of Measurement (using test site) and evaluation of the corresponding measurement uncertainties".
- ANSI C63.5 (2006): "American National Standard for Calibration of Antennas Used for Radiated Emission Measurements in Electro Magnetic Interference".

~~Directive 98/34/EC of the European Parliament and of the Council laying down a procedure for the provision of information in the field of technical standards and regulations and of rules on information society services.~~

~~Directive 98/48/EC of the European Parliament and of the Council of 20 July 1998 amending Directive 98/34/EC laying down a procedure for the provision of information in the field of technical standards and regulations.~~

## Annex J (informative):

### Change history

<u>Version</u>	<u>Information about changes</u>
<u>2.1.1</u>	<u>First version of the Harmonised Standard under the Radio Equipment Directive</u>
<u>2.2.1</u>	Implemented changes: <ul style="list-style-type: none"> <li>• <u>New technical requirement for the measured -40 dB bandwidth added</u></li> <li>• <u>New technical requirement for OoB emission limits for multiple non-adjacent carrier frequencies added</u></li> <li>• <u>New technical requirement for unwanted emission limits for multi-frequency radars added</u></li> <li>• <u>New technical requirement for Stand-by Mode Emissions added</u></li> <li>• <u>New technical requirement for System Noise Figure added</u></li> <li>• <u>New technical requirement for Receiver Compression level added</u></li> <li>• <u>Modified requirement: the Receiver Selectivity mask is defined with a roll-off -30 dB/dec all the way to max. disturbance level (6 dB below compression level for the given receiver design).</u></li> </ul>

## History

Document history		
V1.1.1	September 2014	Publication
<del>V2.1.0</del>	<del>March 2016</del>	<del>EN Approval Procedure AP 20160605: 2016-03-07 to 2016-06-06</del>
V2.1.1	June 2016	Publication
<u>V2.1.2</u>	<u>August 2020</u>	<u>EN Approval Procedure AP 20201118: 2020-08-20 to 2020-11-18</u>
<u>V2.2.1</u>	<u>November 2020</u>	<u>Publication</u>