

# Text Comparison

## Documents Compared

en\_301442v010101p.pdf

en\_301442v010201p.pdf

## Summary

2470 word(s) added

2471 word(s) deleted

11796 word(s) matched

77 block(s) matched

To see where the changes are, please scroll down.

# ~~ETSI EN 301 442~~ ~~V1.1.1~~ (2000-05)

~~Candidate~~ Harmonized European Standard (Telecommunications series)

**Satellite Earth Stations and Systems (SES);  
Harmonized EN for Mobile Earth Stations (MESS),  
including handheld earth stations, for Satellite  
Personal Communications Networks (S-PCN)  
in the 2,0 GHz bands under the Mobile Satellite  
Service (MSS) covering essential requirements  
under ~~Article~~ 3.2 of the R&TTE directive**



# ETSI EN 301 442 V1.2.1 (2010-08)

---

*Harmonized European Standard (Telecommunications series)*

**Satellite Earth Stations and Systems (SES);  
Harmonized EN for Mobile Earth Stations (MESS),  
including handheld earth stations, for Satellite  
Personal Communications Networks (S-PCN)  
in the 2,0 GHz bands under the Mobile Satellite  
Service (MSS) covering essential requirements  
under article 3.2 of the R&TTE directive**

---



---

**Reference**~~DEN/SEC-000-TBR-42~~

---

**Keywords**

---

satellite, earth station, MES, S-PCN, MSS,  
regulation**ETSI**

---

650 Route des Lucioles  
F-06921 Sophia Antipolis Cedex - FRANCE

---

Tel.: +33 4 92 94 42 00 Fax: +33 4 93 65 47 16

Siret N° 348 623 562 00017 - NAF 742 C  
Association à but non lucratif enregistrée à la  
Sous-Préfecture de Grasse (06) N° 7803/88

---

**Important notice**

---

Individual copies of the present document can be downloaded from:

<http://www.etsi.org>

The present document may be made available in more than one electronic version or in print. In any case of existing or perceived difference in contents between such versions, the reference version is the Portable Document Format (PDF).

In case of dispute, the reference shall be the printing on ETSI printers of the PDF version kept on a specific network drive within ETSI Secretariat.

Users of the present document should be aware that the document may be subject to revision or change of status.

Information on the current status of this and other ETSI documents is available at <http://www.etsi.org/tb/status/>

If you find errors in the present document, send your comment to:

~~editor@etsi.fr~~

---

**Copyright Notification**

---

No part may be reproduced except as authorized by written permission.  
The copyright and the foregoing restriction extend to reproduction in all media.

© European Telecommunications Standards Institute ~~2000~~.  
All rights reserved.

---

**Reference****REN/SES-00308**

---

**Keywords**satellite, earth station, MES, S-PCN, MSS,  
regulation**ETSI**650 Route des Lucioles  
F-06921 Sophia Antipolis Cedex - FRANCE

Tel.: +33 4 92 94 42 00 Fax: +33 4 93 65 47 16

Siret N° 348 623 562 00017 - NAF 742 C  
Association à but non lucratif enregistrée à la  
Sous-Préfecture de Grasse (06) N° 7803/88

---

**Important notice**

Individual copies of the present document can be downloaded from:

<http://www.etsi.org>

The present document may be made available in more than one electronic version or in print. In any case of existing or perceived difference in contents between such versions, the reference version is the Portable Document Format (PDF). In case of dispute, the reference shall be the printing on ETSI printers of the PDF version kept on a specific network drive within ETSI Secretariat.

Users of the present document should be aware that the document may be subject to revision or change of status. Information on the current status of this and other ETSI documents is available at

<http://portal.etsi.org/tb/status/status.asp>

If you find errors in the present document, please send your comment to one of the following services:

[http://portal.etsi.org/chaicor/ETSI\\_support.asp](http://portal.etsi.org/chaicor/ETSI_support.asp)

---

**Copyright Notification**

No part may be reproduced except as authorized by written permission.  
The copyright and the foregoing restriction extend to reproduction in all media.

© European Telecommunications Standards Institute 2010.  
All rights reserved.

DECT™, PLUGTESTS™, UMTS™, TIPHON™, the TIPHON logo and the ETSI logo are Trade Marks of ETSI registered for the benefit of its Members.

3GPP™ is a Trade Mark of ETSI registered for the benefit of its Members and of the 3GPP Organizational Partners.

LTE™ is a Trade Mark of ETSI currently being registered for the benefit of its Members and of the 3GPP Organizational Partners.

GSM® and the GSM logo are Trade Marks registered and owned by the GSM Association.

# Contents

Intellectual Property Rights .....	6
Foreword .....	6
Introduction .....	7
<b>1</b> Scope .....	9
<b>2</b> References .....	9
<b>3</b> Definitions and abbreviations .....	10
<b>3.1</b> Definitions .....	10
<b>3.2</b> Abbreviations .....	11
<b>4</b> Technical requirements specifications .....	12
<b>4.1</b> Environmental profile .....	12
<b>4.1.1</b> General .....	12
<b>4.1.2</b> Temperature .....	12
<b>4.1.3</b> Voltage .....	12
<b>4.1.4</b> Vibration .....	12
<b>4.2</b> Conformance requirements .....	13
4.2.1 Unwanted emissions outside the band 1 980,1 MHz to 2 009,9 MHz (carrier-on) .....	13
<b>4.2.1.1</b> Justification .....	13
<b>4.2.1.2</b> Technical Requirement .....	13
4.2.1.3 Conformance Test .....	13
4.2.2 Unwanted emissions within the bands 1 980,1 MHz to 2 009,9 MHz, 1 978,1 MHz to 1 980,1 MHz and 2 009,9 MHz to 2 011,9 MHz (carrier-on) .....	13
<b>4.2.2.1</b> Justification .....	13
<b>4.2.2.2</b> Technical Requirement .....	14
<b>4.2.2.3</b> Conformance Test .....	14
4.2.3 Unwanted emissions in carrier-off state .....	14
<b>4.2.3.1</b> Justification .....	14
<b>4.2.3.2</b> Technical Requirement .....	14
<b>4.2.3.3</b> Conformance Test .....	15
<b>4.2.4</b> MES Control and Monitoring Functions (CMF) .....	15
<b>4.2.4.1</b> Self-monitoring functions / Processor monitoring .....	15
<b>4.2.4.1.1</b> Justification .....	15
<b>4.2.4.1.2</b> Technical Requirement .....	15
<b>4.2.4.1.3</b> Conformance Test .....	15
4.2.4.2 Self-monitoring functions / Transmit frequency generation sub-system monitoring .....	15
<b>4.2.4.2.1</b> Justification .....	15
<b>4.2.4.2.2</b> Technical Requirement .....	15
<b>4.2.4.2.3</b> Conformance Test .....	16
<b>4.2.4.3</b> Network control authorization .....	16
<b>4.2.4.3.1</b> Justification .....	16
<b>4.2.4.3.2</b> Technical Requirement .....	16
<b>4.2.4.3.3</b> Conformance Test .....	16
4.2.4.4 Network control reception .....	16
<b>4.2.4.4.1</b> Transmit frequency control .....	16
<b>4.2.4.4.1.1</b> Justification .....	16
<b>4.2.4.4.1.2</b> Technical Requirement .....	16
<b>4.2.4.4.1.3</b> Conformance Test .....	16
4.2.4.5 Fellow radio stations in a dual-mode or multi-mode terminal .....	16
<b>4.2.4.5.1</b> Justification .....	16
<b>4.2.4.5.2</b> Technical Requirement .....	16
<b>4.2.4.5.3</b> Conformance Test .....	17
<b>4.2.5</b> Equipment identity .....	17
<b>4.2.5.1</b> Justification .....	17

# Contents

<b>Intellectual Property Rights</b>	<b>6</b>
<b>Foreword</b>	<b>6</b>
<b>Introduction</b>	<b>6</b>
<b>1 Scope</b>	<b>7</b>
<b>2 References</b>	<b>7</b>
2.1 Normative references	7
2.2 Informative references	8
<b>3 Definitions and abbreviations</b>	<b>8</b>
3.1 Definitions	8
3.2 Abbreviations	10
<b>4 Technical requirements specifications</b>	<b>10</b>
4.1 Environmental profile	10
4.1.1 General	10
4.1.2 Temperature	10
4.1.3 Voltage	10
4.1.4 Vibration	10
4.2 Conformance requirements	11
4.2.1 Unwanted emissions outside the band 1 980,1 MHz to 2 009,9 MHz (carrier-on)	11
4.2.1.1 Justification	11
4.2.1.2 Technical Requirement	11
4.2.1.3 Conformance Test	11
4.2.2 Unwanted emissions within the bands 1 980,1 MHz to 2 009,9 MHz, 1 978,1 MHz to 1 980,1 MHz and 2 009,9 MHz to 2 011,9 MHz (carrier-on)	12
4.2.2.1 Justification	12
4.2.2.2 Technical Requirement	12
4.2.2.3 Conformance Test	12
4.2.3 Unwanted emissions in carrier-off state	12
4.2.3.1 Justification	12
4.2.3.2 Technical Requirement	13
4.2.3.3 Conformance Test	13
4.2.4 MES Control and Monitoring Functions (CME)	13
4.2.4.1 Self-monitoring functions / Processor monitoring	13
4.2.4.1.1 Justification	13
4.2.4.1.2 Technical Requirement	13
4.2.4.1.3 Conformance Test	13
4.2.4.2 Self-monitoring functions / Transmit frequency generation sub-system monitoring	13
4.2.4.2.1 Justification	13
4.2.4.2.2 Technical Requirement	14
4.2.4.2.3 Conformance Test	14
4.2.4.3 Network control authorization	14
4.2.4.3.1 Justification	14
4.2.4.3.2 Technical Requirement	14
4.2.4.3.3 Conformance Test	14
4.2.4.4 Network control reception	14
4.2.4.4.1 Transmit frequency control	14
4.2.4.5 Fellow radio stations in a dual-mode or multi-mode terminal	15
4.2.4.5.1 Justification	15
4.2.4.5.2 Technical Requirement	15
4.2.4.5.3 Conformance Test	15
4.2.5 Equipment identity	15
4.2.5.1 Justification	15
4.2.5.2 Technical Requirement	15
4.2.5.3 Conformance Test	15



<del>4.2.5.2</del>	<del>Technical Requirement .....</del>	<del>17</del>
<del>4.2.5.3</del>	<del>Conformance Test .....</del>	<del>17</del>
<del>5</del>	<del>Testing for compliance with technical requirements .....</del>	<del>17</del>
<del>5.1</del>	<del>Environmental conditions for testing .....</del>	<del>17</del>
<del>5.1.1</del>	<del>Specification of the environmental test conditions .....</del>	<del>17</del>
<del>5.1.2</del>	<del>Tests under extreme voltage conditions .....</del>	<del>17</del>
<del>5.2</del>	<del>Essential radio test suites .....</del>	<del>18</del>
<del>5.2.1</del>	<del>General .....</del>	<del>18</del>
<del>5.2.1.1</del>	<del>Presentation of equipment for testing purposes .....</del>	<del>18</del>
<del>5.2.1.2</del>	<del>Description of equipment .....</del>	<del>18</del>
<del>5.2.1.3</del>	<del>Testing of host-connected equipment and plug-in modules .....</del>	<del>19</del>
<del>5.2.1.3.1</del>	<del>Alternative approaches .....</del>	<del>19</del>
<del>5.2.1.3.2</del>	<del>Alternative A: combined equipment .....</del>	<del>19</del>
<del>5.2.1.3.3</del>	<del>Alternative B: use of a test jig .....</del>	<del>19</del>
<del>5.2.1.4</del>	<del>CMF / Special Test Equipment (STE) .....</del>	<del>19</del>
<del>5.2.1.5</del>	<del>General test requirements .....</del>	<del>20</del>
<del>5.2.1.5.1</del>	<del>MES test modes .....</del>	<del>20</del>
<del>5.2.1.5.2</del>	<del>Special Test Equipment .....</del>	<del>20</del>
<del>5.2.1.5.2.1</del>	<del>Use of STE for control and monitoring functions tests .....</del>	<del>20</del>
<del>5.2.1.5.2.2</del>	<del>Test modulating signal .....</del>	<del>21</del>
<del>5.2.1.5.3</del>	<del>Laboratory Test Equipment (LTE) .....</del>	<del>21</del>
<del>5.2.1.5.4</del>	<del>Method of test for MES RF emissions according to equipment type .....</del>	<del>22</del>
<del>5.2.1.5.5</del>	<del>Procedures for measurement of MES RF radiated emissions .....</del>	<del>22</del>
<del>5.2.1.5.5.1</del>	<del>General .....</del>	<del>22</del>
<del>5.2.1.5.5.1.1</del>	<del>Test site .....</del>	<del>22</del>
<del>5.2.1.5.5.1.2</del>	<del>Test set-up for radiated emissions of the MES .....</del>	<del>22</del>
<del>5.2.1.5.5.1.3</del>	<del>Reference position of the MES .....</del>	<del>23</del>
<del>5.2.1.5.5.2</del>	<del>Measurement procedure for radiated emissions (peak) .....</del>	<del>23</del>
<del>5.2.1.5.5.2.1</del>	<del>Measurement procedure for peak radiated emissions of the MES .....</del>	<del>23</del>
<del>5.2.1.5.5.2.2</del>	<del>Measurement procedure for peak radiated emissions of the cabinet .....</del>	<del>25</del>
<del>5.2.1.5.5.3</del>	<del>Measurement procedure for radiated emissions (average) .....</del>	<del>25</del>
<del>5.2.1.5.5.3.1</del>	<del>Measurement procedure for average radiated emissions of the MES .....</del>	<del>25</del>
<del>5.2.1.5.5.3.2</del>	<del>Measurement procedure for average radiated emissions of the cabinet .....</del>	<del>26</del>
<del>5.2.1.5.6</del>	<del>Procedures for measurement of MES RF conducted emissions .....</del>	<del>26</del>
<del>5.2.1.5.6.1</del>	<del>General .....</del>	<del>26</del>
<del>5.2.1.5.6.1.1</del>	<del>Test site .....</del>	<del>27</del>
<del>5.2.1.5.6.1.2</del>	<del>Test set-up .....</del>	<del>27</del>
<del>5.2.1.5.6.2</del>	<del>Measurement procedure for conducted emissions (peak) .....</del>	<del>27</del>
<del>5.2.1.5.6.3</del>	<del>Measurement procedure for conducted emissions (average) .....</del>	<del>27</del>
<del>5.2.1.5.7</del>	<del>Interpretation of the measurement results .....</del>	<del>28</del>
<del>5.2.1.5.8</del>	<del>Test report .....</del>	<del>28</del>
<del>5.2.2</del>	<del>Unwanted emissions outside the band 1 980,1 MHz to 2 009,9 MHz (carrier-on) .....</del>	<del>28</del>
<del>5.2.2.1</del>	<del>Method of test .....</del>	<del>28</del>
<del>5.2.2.2</del>	<del>Peak measurement .....</del>	<del>29</del>
<del>5.2.2.3</del>	<del>Average measurement .....</del>	<del>29</del>
<del>5.2.2.4</del>	<del>Test requirements .....</del>	<del>29</del>
<del>5.2.3</del>	<del>Unwanted emissions within the bands 1 980,1 MHz to 2 009,9 MHz, 1 978,1 MHz to 1 980,1 MHz and 2 009,9 MHz to 2 011,9 MHz (carrier-on) .....</del>	<del>29</del>
<del>5.2.3.1</del>	<del>Method of test .....</del>	<del>29</del>
<del>5.2.3.2</del>	<del>Measurement method .....</del>	<del>30</del>
<del>5.2.3.3</del>	<del>Test requirements .....</del>	<del>30</del>
<del>5.2.4</del>	<del>Unwanted emissions in carrier-off state .....</del>	<del>30</del>
<del>5.2.4.1</del>	<del>Method of test .....</del>	<del>30</del>
<del>5.2.4.2</del>	<del>Measurement method .....</del>	<del>31</del>
<del>5.2.4.3</del>	<del>Test requirements .....</del>	<del>31</del>
<del>5.2.5</del>	<del>MES Control and Monitoring Functions (CMF) .....</del>	<del>31</del>
<del>5.2.5.1</del>	<del>Self-monitoring functions / Processor Monitoring .....</del>	<del>31</del>
<del>5.2.5.2</del>	<del>Self-monitoring functions / Transmit frequency generation sub-system monitoring .....</del>	<del>31</del>
<del>5.2.5.3</del>	<del>Network control authorization .....</del>	<del>31</del>
<del>5.2.5.3.1</del>	<del>Method of test .....</del>	<del>31</del>

<b>5</b>	<b>Testing for compliance with technical requirements</b>	<b>15</b>
<b>5.1</b>	<b>Environmental conditions for testing</b>	<b>15</b>
5.1.1	Specification of the environmental test conditions	15
5.1.2	Tests under extreme voltage conditions	16
<b>5.2</b>	<b>Essential radio test suites</b>	<b>16</b>
<b>5.2.1</b>	<b>General</b>	<b>16</b>
5.2.1.1	Presentation of equipment for testing purposes	16
5.2.1.2	Description of equipment	16
5.2.1.3	Testing of host-connected equipment and plug-in modules	17
5.2.1.3.1	Alternative approaches	17
5.2.1.3.2	Alternative A: combined equipment	17
5.2.1.3.3	Alternative B: use of a test jig	17
5.2.1.4	CMF / Special Test Equipment (STE)	17
5.2.1.5	General test requirements	18
5.2.1.5.1	MES test modes	18
5.2.1.5.2	Special Test Equipment	18
5.2.1.5.3	Laboratory Test Equipment (LTE)	19
5.2.1.5.4	Method of test for MES RF emissions according to equipment type	20
5.2.1.5.5	Procedures for measurement of MES RF radiated emissions	20
5.2.1.5.6	Procedures for measurement of MES RF conducted emissions	24
5.2.1.5.7	Interpretation of the measurement results	26
5.2.1.5.8	Test report	26
5.2.2	Unwanted emissions outside the band 1 980,1 MHz to 2 009,9 MHz (carrier-on)	26
5.2.2.1	Method of test	26
5.2.2.2	Peak measurement	26
5.2.2.3	Average measurement	27
5.2.2.4	Test requirements	27
5.2.3	Unwanted emissions within the bands 1 980,1 MHz to 2 009,9 MHz, 1 978,1 MHz to 1 980,1 MHz and 2 009,9 MHz to 2 011,9 MHz (carrier-on)	27
5.2.3.1	Method of test	27
5.2.3.2	Measurement method	28
5.2.3.3	Test requirements	28
5.2.4	Unwanted emissions in carrier-off state	28
5.2.4.1	Method of test	28
5.2.4.2	Measurement method	29
5.2.4.3	Test requirements	29
5.2.5	MES Control and Monitoring Functions (CME)	29
5.2.5.1	Self-monitoring functions / Processor Monitoring	29
5.2.5.2	Self-monitoring functions / Transmit frequency generation sub-system monitoring	29
5.2.5.3	Network control authorization	29
5.2.5.3.1	Method of test	29
5.2.5.3.2	Test procedure	30
5.2.5.3.3	Test requirement	30
5.2.5.4	Network control reception	30
5.2.5.4.1	Transmit frequency control	30
5.2.5.5	Fellow radio stations in a dual-mode or multi-mode terminal	31
5.2.5.5.1	Method of test	31
5.2.5.5.2	Test procedure	31
5.2.5.5.3	Test requirements	31
5.2.6	Equipment identity	31
5.2.6.1	Method of test	31
5.2.6.2	Test procedure	31
5.2.6.3	Test requirements	31
<b>Annex A (normative):</b>	<b>HS Requirements and conformance Test specifications Table (HS-RTT)</b>	<b>32</b>
<b>Annex B (informative):</b>	<b>Explanation of nominated bandwidth</b>	<b>34</b>
<b>B.1</b>	<b>Introduction</b>	<b>34</b>
<b>B.2</b>	<b>Interpretation of Parameters <math>[B_n, f_c, a, b]</math></b>	<b>34</b>

<del>5.2.5.3.2</del>	<del>Test procedure .....</del>	<del>32</del>
<del>5.2.5.3.3</del>	<del>Test requirement .....</del>	<del>32</del>
<del>5.2.5.4</del>	<del>Network control reception .....</del>	<del>32</del>
<del>5.2.5.4.1</del>	<del>Transmit frequency control .....</del>	<del>32</del>
<del>5.2.5.4.1.1</del>	<del>Method of test .....</del>	<del>32</del>
<del>5.2.5.4.1.2</del>	<del>Test procedure .....</del>	<del>32</del>
<del>5.2.5.4.1.3</del>	<del>Test requirement .....</del>	<del>33</del>
<del>5.2.5.5</del>	<del>Fellow radio stations in a dual-mode or multi-mode terminal .....</del>	<del>33</del>
<del>5.2.5.5.1</del>	<del>Method of test .....</del>	<del>33</del>
<del>5.2.5.5.2</del>	<del>Test procedure .....</del>	<del>33</del>
<del>5.2.5.5.3</del>	<del>Test requirements .....</del>	<del>33</del>
<del>5.2.6</del>	<del>Equipment identity .....</del>	<del>33</del>
<del>5.2.6.1</del>	<del>Method of test .....</del>	<del>33</del>
<del>5.2.6.2</del>	<del>Test procedure .....</del>	<del>34</del>
<del>5.2.6.3</del>	<del>Test requirements .....</del>	<del>34</del>
<del>Annex A (normative):</del>	<del>The EN Requirements Table (EN-RT) .....</del>	<del>35</del>
<del>Annex B (informative):</del>	<del>Explanation of nominated bandwidth .....</del>	<del>36</del>
<del>B.1</del>	<del>Introduction .....</del>	<del>36</del>
<del>B.2</del>	<del>Interpretation of Parameters <math>[B_n, f_c, a, b]</math> .....</del>	<del>36</del>
<del>B.3</del>	<del>Choice of nominated bandwidth .....</del>	<del>36</del>
<del>B.4</del>	<del>Maximum value for nominated bandwidth .....</del>	<del>38</del>
<del>Bibliography</del>	<del>.....</del>	<del>40</del>
<del>History</del>	<del>.....</del>	<del>41</del>

<u>B.3</u>	<u>Choice of nominated bandwidth</u>	<u>34</u>
<u>B.4</u>	<u>Maximum value for nominated bandwidth</u>	<u>36</u>
<u>Annex C (informative):</u>	<u>The EN title in the official languages</u>	<u>38</u>
<u>Annex D (informative):</u>	<u>Bibliography</u>	<u>39</u>
<u>History</u>		<u>40</u>

---

## Intellectual Property Rights

IPRs essential or potentially essential to the present document may have been declared to ETSI. The information pertaining to these essential IPRs, if any, is publicly available for **ETSI members and non-members**, and can be found in SR 000 314: "*Intellectual Property Rights (IPRs); Essential, or potentially Essential, IPRs notified to ETSI in respect of ETSI standards*", which is available from the ETSI Secretariat. Latest updates are available on the ETSI Web server (<http://www.etsi.org/ipr>).

Pursuant to the ETSI IPR Policy, no investigation, including IPR searches, has been carried out by ETSI. No guarantee can be given as to the existence of other IPRs not referenced in SR 000 314 (or the updates on the ETSI Web server) which are, or may be, or may become, essential to the present document.

---

## Foreword

This ~~Candidate~~ Harmonized European Standard (Telecommunications series) has been produced by ETSI Technical Committee Satellite Earth Stations and Systems (SES).

The present document has been produced by ETSI in response to a mandate from the European Commission issued under Council Directive 98/34/EC [6] (as amended) laying down a procedure for the provision of information in the field of technical standards and regulations.

The present document is intended to become a Harmonized Standard, the reference of which will be published in the Official Journal of the European Communities referencing the Directive 1999/5/EC [1] of the European Parliament and of the Council of 9 March 1999 on radio equipment and telecommunications terminal equipment and the mutual recognition of their conformity ("the R&TTE Directive").

<b>National transposition dates</b>	
Date of adoption of this EN:	<del>28 April 2000</del>
Date of latest announcement of this EN (doa):	<del>31 July 2000</del>
Date of latest publication of new National Standard or endorsement of this EN (dop/e):	31 <del>January 2001</del>
Date of withdrawal of any conflicting National Standard (dow):	31 <del>January 2001</del>

---

## Intellectual Property Rights

IPRs essential or potentially essential to the present document may have been declared to ETSI. The information pertaining to these essential IPRs, if any, is publicly available for **ETSI members and non-members**, and can be found in **ETSI SR 000 314: "Intellectual Property Rights (IPRs); Essential, or potentially Essential, IPRs notified to ETSI in respect of ETSI standards"**, which is available from the ETSI Secretariat. Latest updates are available on the ETSI Web server (<http://webapp.etsi.org/IPR/home.asp>).

Pursuant to the ETSI IPR Policy, no investigation, including IPR searches, has been carried out by ETSI. No guarantee can be given as to the existence of other IPRs not referenced in SR 000 314 (or the updates on the ETSI Web server) which are, or may be, or may become, essential to the present document.

---

## Foreword

This Harmonized European Standard (Telecommunications series) has been produced by ETSI Technical Committee Satellite Earth Stations and Systems (SES).

The present document has been produced by ETSI in response to a mandate from the European Commission issued under Council Directive 98/34/EC [6] (as amended) laying down a procedure for the provision of information in the field of technical standards and regulations.

The present document is intended to become a Harmonized Standard, the reference of which will be published in the Official Journal of the European Communities referencing the Directive 1999/5/EC [1] of the European Parliament and of the Council of 9 March 1999 on radio equipment and telecommunications terminal equipment and the mutual recognition of their conformity ("the R&TTE Directive").

The requirements relevant to Directive 1999/5/EC [1] are summarised in annex A.

<b>National transposition dates</b>	
Date of adoption of this EN:	<u>2 August 2010</u>
Date of latest announcement of this EN (doa):	<u>30 November 2010</u>
Date of latest publication of new National Standard or endorsement of this EN (dop/e):	31 <u>May 2011</u>
Date of withdrawal of any conflicting National Standard (dow):	31 <u>May 2012</u>

---

## Introduction

The present document is part of a set of standards developed by ETSI and is designed to fit in a modular structure to cover all radio and telecommunications terminal equipment within the scope of the R&TTE Directive [1]. The modular structure is shown in EG 201 399 [i 1].

# Introduction

ETSI has designed a modular structure for the standards. Each standard is a module in the structure. The modular structure is shown in figure 1.

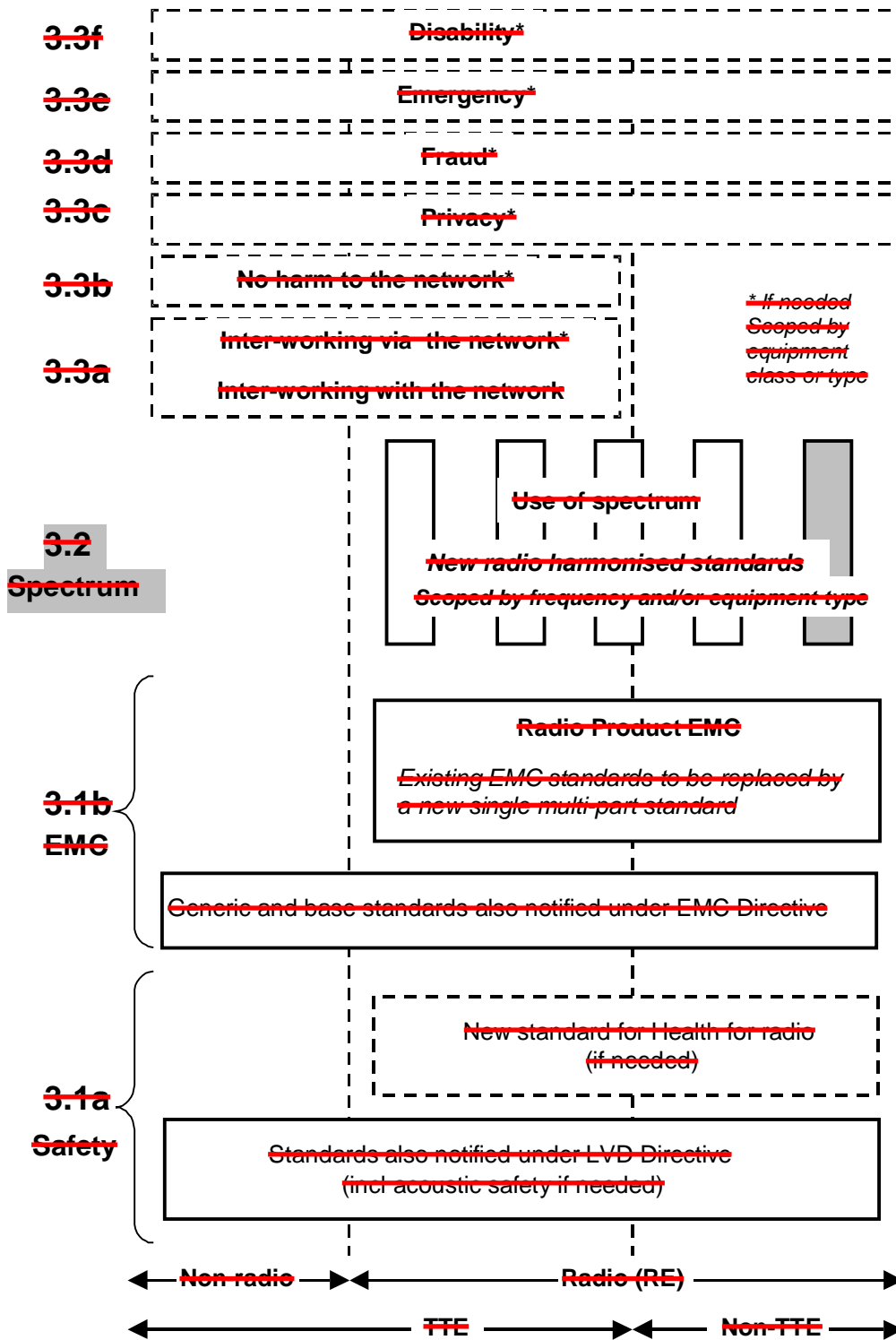

Figure 1: Modular structure for the various standards used under the R&TTE Directive

The left hand edge of the figure shows the different subclauses of Article 3 of the Directive.

# 1 Scope

The present document applies to Mobile Earth Station (MES) radio equipment which have the following characteristics:

- these MES operate in a non-geostationary orbit (NGSO) mobile-satellite system;
- these MES have both transmit and receive capabilities and operate in a Satellite-Personal Communications Network (S-PCN). An S-PCN MES may be handheld, portable, vehicle-mounted, host connected, semi-fixed or fixed equipment, or may be an element in a multi-mode terminal. It may consist of a number of modules with associated connections and user interface, or may be a self contained single unit;
- these LMESs are controlled and monitored by a Network Control Facility (NCF). The NCF is outside the scope of the present document;
- if the MES is an element in a multi-mode terminal, unless otherwise stated in the present document, its requirements apply only to the S-PCN MES element of the terminal operating in the MSS frequency bands given in table 1;
- these MES are capable in operating in all or part of the frequency bands shown in table 1.

**Table 1: Mobile Satellite Service (MSS) frequency bands**

MES	MSS frequency bands
Transmit (earth to space)	1 980 MHz to 2 010 MHz
Receive (space to earth)	2 170 MHz to 2 200 MHz

The present document is intended to cover the provisions of Directive 1999/5/EC [1] (R&TTE Directive) article 3.2 which states that "...radio equipment shall be so constructed that it effectively uses the spectrum allocated to terrestrial/space radio communications and orbital resources so as to avoid harmful interference".

In addition to the present document, other ENs that specify technical requirements in respect of essential requirements under other parts of article 3 of the R&TTE Directive [1] may apply to equipment within the scope of the present document.

NOTE: A list of such ENs is included on the ETSI web site.

## 2 References

References are either specific (identified by date of publication and/or edition number or version number) or non-specific. For specific references, only the cited version applies. For non-specific references, the latest version of the referenced document (including any amendments) applies.

Referenced documents which are not found to be publicly available in the expected location might be found at <http://docbox.etsi.org/Reference>.

NOTE: While any hyperlinks included in this clause were valid at the time of publication ETSI cannot guarantee their long term validity.

### 2.1 Normative references

The following referenced documents are necessary for the application of the present document.

- [1] Directive 1999/5/EC of the European Parliament and of the Council of 9 March 1999 on radio equipment and telecommunications terminal equipment and the mutual recognition of their conformity (R&TTE Directive).
- [2] ITU-T Recommendation Q.153 (1992): "Basic parameters for the measurement of error performance at bit rates below the primary rate".



~~For article 3.3 various horizontal boxes are shown. Their dotted lines indicate that no essential requirements in these areas have yet been adopted by the Commission. If such essential requirements are adopted, they will be elaborated in individual standards whose scope is likely to be specified by function or interface type.~~

~~The vertical boxes show the standards under article 3.2 for the use of the radio spectrum. The scopes of these standards are specified either by frequency (normally in the case where frequency bands are harmonized) or by radio equipment type.~~

~~For article 3.1(b), the diagram shows the new single multi-part product EMC standard for radio, and the existing collection of generic and base standards currently used under the EMC Directive. The parts of this new standard will become available in the second half of 2 000, and the existing separate EMC standards will be used until it is available.~~

~~For article 3.1(a) the diagram shows the existing safety standards currently used under the LVD Directive and the possibility of a new standard on health relating to radio emissions~~

~~The bottom of the figure shows the relationship of the standards to radio equipment and telecommunications terminal equipment. A particular equipment may be radio equipment, telecommunications terminal equipment or both.~~

~~The modular approach has been taken because:~~

- ~~— it minimizes the number of standards needed. Because equipment may have multiple interfaces and functions it is not practicable to produce a single standard for each possible combination of functions that may occur in an equipment.~~
- ~~— it provides scope for standards to be added:
  - ~~— under article 3.2 when new frequency bands are agreed, or~~
  - ~~— under article 3.3 should the Commission take the necessary decisions,~~~~
- ~~without requiring alteration of standards that are already published.~~

~~The present document is based on TBR 042 [7].~~

~~The technical requirements in the present document are applied under Article 3.2 of the R&TTE Directive concerning the effective use of the spectrum allocated to terrestrial/space radio communications and orbital resources so as to avoid harmful interference. These requirements are in two major categories:~~

~~**unwanted emissions limits:** to protect other radio services from harmful interference generated by the MES in normal use.~~

~~**MES Control and Monitoring Functions (CMF):** to protect other radio services from unwanted transmissions from the MES. The CMF in each MES is capable of answering to commands from the Network Control Facilities (NCF) for its S-PCN.~~

~~The requirements for Network Control Facilities (NCF) for S-PCN are contained in ETS 300 735 [8].~~

~~The determination of the parameters of the user earth stations using a given satellite constellation for the protection of the spectrum allocated to that satellite constellation, is considered to be under the responsibility of the satellite operator or the satellite network operators.~~

- [3] [IEC 60068-2-1 \(March 2007\): "Environmental testing - Part 2-1: Tests - Test A: Cold"](#)
- [4] [IEC 60068-2-2 \(July 2007\): "Environmental testing - Part 2-2: Tests - Test B: Dry heat"](#)
- [5] [IEC 60068-2-64 \(2008-04\) Ed. 2.0: "Environmental testing - Part 2-64: Tests - Test Eh: Vibration, broadband random and guidance"](#)
- [6] Directive 98/34/EC of the European Parliament and of the Council of 22 June 1998 laying down a procedure for the provision of information in the field of technical standards and regulations.

## 2.2 [Informative references](#)

[The following referenced documents are not necessary for the application of the present document but they assist the user with regard to a particular subject area.](#)

- [i.1] [ETS I ELEG 201 399: "Electromagnetic compatibility and Radio spectrum Matters \(ERM\): A guide to the production of candidate Harmonized Standards for application under the R&TTE Directive"](#)

---

## 3 Definitions and abbreviations

### 3.1 Definitions

For the purposes of the present document, the terms and definitions given in the R&TTE Directive [\[1\]](#) and the following apply:

**applicant:** manufacturer or his representative within the European Community or the person responsible for placing the apparatus on the [market](#)

**carrier-on state (allocated a channel):** MES is in this state when it is transmitting a signal in a continuous or [non-continuous mode](#)

**carrier-off state (idle mode):** MES is in this state when it is powered-on but not transmitting a signal, i.e. not in [carrier-on state](#)

**conducted measurement:** measurement of emissions from an antenna port of the MES made by direct wired connection to the [port](#)

**Equivalent Isotropically Radiated Power (EIRP):** product of transmitter power and maximum antenna gain, equivalent to an isotropic source radiating uniformly in all [directions](#)

**environmental profile:** range of environmental conditions under which equipment within the scope of the present document is required to comply with the provisions of the present [document](#)

**handheld:** indicates a PE MES which is self-contained and is small enough and light enough to be carried and used during a call with one [hand](#)

**host-connected:** indicates an MES for which connection to or integration with host equipment is necessary to offer [functionality](#)

**host equipment:** any equipment which has a complete user functionality when not connected to the MES, and to which the MES provides additional functionality, and to which connection is necessary for the MES to offer [functionality](#)

**Installable Equipment (IE), Internally Mounted Equipment (IME) and Externally Mounted Equipment (EME):** Installable Equipment (IE) is an equipment which is intended to be installed in a [vehicle](#)

**NOTE:** An IE may consist of one or several interconnected modules. The IE is composed of modules intended to be externally mounted as declared by the applicant, and defined as Externally Mounted Equipment (EME) and the remaining module(s) as Internally Mounted Equipment (IME).

# 1 Scope

The present document applies to Mobile Earth Station (MES) radio equipment which have the following characteristics:

- these MES have both ~~transmitted~~ and receive capabilities and operate in a Satellite-Personal Communications Network (S-PCN). An S-PCN MES may be handheld, portable, vehicle-mounted, host connected, semi-fixed or fixed equipment, or may be an element in a multi-mode terminal. It may consist of a number of modules with associated connections and user interface, or may be a self contained single unit;
- these LMESs are controlled and monitored by a Network Control Facility (NCF). The NCF is outside the scope of the present document;
- if the MES is an element in a multi-mode terminal, unless otherwise stated in the present document, its requirements apply only to the S-PCN MES element of the terminal operating in the MSS frequency bands given in table 1;
- these MES are capable in operating in all or part of the frequency bands shown in table 1.

**Table 1: Mobile Satellite Service (MSS) frequency bands**

MES	MSS frequency bands
Transmit (earth to space)	1 980 MHz to 2 010 MHz
Receive (space to earth)	2 170 MHz to 2 200 MHz

The present document is intended to cover the provisions of Directive 1999/5/EC [1] (R&TTE Directive) ~~Article~~ 3.2 which states that "...radio equipment shall be so constructed that it effectively uses the spectrum allocated to terrestrial/space radio communications and orbital resources so as to avoid harmful interference".

In addition to the present document, other ENs that specify technical requirements in respect of essential requirements under other parts of ~~Article~~ 3 of the R&TTE Directive [1] may apply to equipment within the scope of the present document.

NOTE: A list of such ENs is included on the ETSI web site.

# 2 References

~~The following documents contain provisions which, through reference in this text, constitute provisions of the present document:~~

- ~~References are either specific (identified by date of publication, edition number, version number, etc.) or non-specific.~~
- ~~For a specific reference, subsequent revisions do not apply.~~
- ~~For a non specific reference, the latest version applies.~~
- ~~A non-specific reference to an ETS shall also be taken to refer to later versions published as an EN with the same number.~~

[1] Directive 1999/5/EC of the European Parliament and of the Council of 9 March 1999 on radio equipment and telecommunications equipment and the mutual recognition of their ~~conformity~~.

[2] ~~CCITT Recommendation O.153 (1988): "Basic parameters for the measurement of error performance at bit rates below the primary rate".~~

[3] ~~IEC Publication 60068-2-1: "Environmental testing - Part 2: Tests. Tests A: Cold".~~

[4] ~~IEC Publication 60068-2-2: "Environmental testing - Part 2: Tests. Tests B: Dry heat".~~

**Laboratory Test Equipment (LTE):** logical grouping that contains the standard test equipment provided by a test laboratory

**MSS band:** continuous range of frequencies allocated by the ITU to the MSS

**multi-mode:** indicates equipment that accommodates radio stations of different radio networks

**narrow-band system:** narrow band system is one in which the nominal carrier frequency spacing for MESs in the earth-to-space direction is less than 300 kHz

**network control channel:** channel by which an MES receives general control information from the NCF of its S-PCN

**NCF control message:** message, normally originating from a network, to a specified terminal or set of terminals of the network which indicates to the terminal or set of terminals that it/they should carry out some specific action or should enter or maintain some specific state

**NOTE:** For test purposes NCF control messages may originate from Special Test Equipment (STE).

**nominated bandwidth (B<sub>n</sub>):** B<sub>n</sub> of the Mobile Earth Station (MES) radio frequency transmission is wide enough to encompass all spectral elements of the transmission which have a level greater than the specified levels of unwanted emissions

**NOTE 1:** The B<sub>n</sub> is defined relative to the MES actual carrier frequency  $f_c$ .

B<sub>n</sub> is the width of the frequency interval ( $f_c - a$ ,  $f_c + b$ ), where a and b, which shall be specified by the applicant, may vary with  $f_c$ .

The frequency interval ( $f_c - a$ ,  $f_c + b$ ) shall not encompass more than either:

- i) when  $a = b$ , 4 nominal carrier frequencies for narrow-band systems;
- ii) when  $a \neq b$ , 1 nominal carrier frequency for narrow-band systems; or
- iii) 1 nominal carrier frequency for wide-band systems.

The frequency interval ( $f_c - a$ ,  $f_c + b$ ) shall be within the operational band of the MES.

**NOTE 2:** Explanation of nominated bandwidth is presented in annex B.

**operational band:** sub-portion of the band 1 980 MHz to 2 010 MHz which has been assigned in the earth-to-space direction to the MSS network, within which the MES is operating

**Portable Equipment (PE):** Portable Equipment (PE) is generally intended to be self-contained, free standing and portable

**NOTE:** A PE would normally consist of a single module, but may consist of several interconnected modules.

**radiated measurement:** measurement of an actual radiated field

**Special Test Equipment (STE):** equipment which allows a test laboratory to control the MES so that the tests required by the present document can be performed

**test laboratory:** laboratory which performs the conformance testing of the MES against the present document. The test laboratory may be the applicant's laboratory

**test load:** test load is a substantially non-reactive, non-radiating power attenuator which is capable of safely dissipating the power from the transmitter(s)

**unwanted emissions:** unwanted emissions are those falling outside the nominated bandwidth in the carrier-on state and those generated in the carrier-off state

**wide-band system:** wide-band system is one in which the nominal carrier frequency spacing for MESs in the earth-to-space direction is equal or greater than 300 kHz

- [5] ~~IEC Publication 60068-2-36: "Environmental testing. Part 2: Tests. Test Fdb: Random vibration wide band - Reproducibility Medium".~~
- [6] Directive 98/34/EC of the European Parliament and of the Council of 22 June 1998 laying down a procedure for the provision of information in the field of technical standards and regulations.
- [7] ~~TBR 042: "Satellite Personal Communications Networks (S-PCN), Mobile Earth Stations (MES), including handheld earth stations, for S-PCN in the 2,0 GHz bands under the Mobile Satellite Service (MSS), Terminal essential requirements".~~
- [8] ~~ETS 300 735: "Satellite Personal Communications Networks (S-PCN), Network Control Facilities (NCF) for Mobile Earth Stations (MES), including handheld earth stations, for S-PCN in the 1,6/2,4 GHz and the 2,0 GHz bands, providing voice and/or data communications under the Mobile Satellite Service (MSS)".~~

## 3 Definitions and abbreviations

### 3.1 Definitions

For the purposes of the present document, the terms and definitions given in the R&TTE Directive [4], and the following terms and definitions apply:

**applicant:** manufacturer or his representative within the European Community or the person responsible for placing the apparatus on the ~~market~~.

**carrier-on state (allocated a channel):** MES is in this state when it is transmitting a signal in a continuous or ~~non-continuous mode~~.

**carrier-off state (idle mode):** MES is in this state when it is powered-on but not transmitting a signal, i.e. not in ~~carrier-on state~~.

**conducted measurement:** measurement of emissions from an antenna port of the MES made by direct wired connection to the ~~port~~.

**Equivalent Isotropically Radiated Power (EIRP):** product of transmitter power and maximum antenna gain, equivalent to an isotropic source radiating uniformly in all ~~directions~~.

**Environmental profile:** range of environmental conditions under which equipment within the scope of the present document is required to comply with the provisions of the present ~~document~~.

**handheld:** indicates a PE MES which is self-contained and is small enough and light enough to be carried and used during a call with one ~~hand~~.

**host-connected:** indicates an MES for which connection to or integration with host equipment is necessary to offer ~~functionality~~.

**host equipment:** ~~is~~ any equipment which has a complete user functionality when not connected to the MES, and to which the MES provides additional functionality, and to which connection is necessary for the MES to offer ~~functionality~~.

**Installable Equipment (IE), Internally Mounted Equipment (IME) and Externally Mounted Equipment (EME):** Installable Equipment (IE) is an equipment which is intended to be installed in a ~~vehicle~~. An IE may consist of one or several interconnected modules. The IE is composed of modules intended to be externally mounted as declared by the applicant, and defined as Externally Mounted Equipment (EME) and the remaining module(s) as Internally Mounted Equipment (IME).

**Laboratory Test Equipment (LTE):** logical grouping that contains the standard test equipment provided by a test ~~laboratory~~.

**MSS band:** continuous range of frequencies allocated by the ITU to the ~~MSS~~.

## 3.2 Abbreviations

For the purposes of the present document, the following abbreviations apply:

Bn	nominated Bandwidth
CDMA	Code Division Multiple Access
CMF	Control and Monitoring Functions
dBW	decibel relative to 1 Watt
EIRP	Equivalent Isotropically Radiated Power
EMC	Electro-Magnetic Compatibility
EME	Externally Mounted Equipment
IE	Installable Equipment
IME	Internally Mounted Equipment
ITU	International Telecommunications Union
LTE	Laboratory Test Equipment
MES	Mobile Earth Station
MIC	MES unique Identification Code (within its S-PCN)
MSS	Mobile Satellite Service
NCF	Network Control Facility
<u>NGSO</u>	<u>Non-GeoStationary Orbit</u>
PE	Portable Equipment
R&TTE	Radio and Telecommunications Terminal Equipment
RF	Radio Frequency
S-PCN	Satellite Personal Communications Network
STE	Special Test Equipment
TDMA	Time Division Multiple Access

---

## 4 Technical requirements specifications

### 4.1 Environmental profile

#### 4.1.1 General

The technical requirements of the present document apply under the environmental profile specified below for operation of the equipment. The equipment shall comply with all the technical requirements of the present document at all times when operating within the boundary limits of the specified operational environmental profile.

#### 4.1.2 Temperature

The MES shall fulfil all the requirements in the full temperature ranges of:

-10 °C to +55 °C;

Taken from IEC publications 60068-2-1 [3] and 60068-2-2 [4].

#### 4.1.3 Voltage

The applicant shall declare the nominal, lower and the higher extreme voltages.

The MES shall fulfil all the requirements in the full voltage range between the extreme voltages.

#### 4.1.4 Vibration

The MES shall fulfil all the requirements when vibrated at the frequency/amplitudes given in table 2.

**multi-mode:** indicates equipment that accommodates radio stations of different radio ~~networks~~.

**narrow-band system:** narrow band system is one in which the nominal carrier frequency spacing for MESs in the earth-to-space direction is less than 300 ~~kHz~~.

**network control channel:** channel by which an MES receives general control information from the NCF of its S-~~PCN~~.

**NCF control message:** message, normally originating from a network, to a specified terminal or set of terminals of the network which indicates to the terminal or set of terminals that it/they should carry out some specific action or should enter or maintain some specific ~~state~~. For test purposes NCF control messages may originate from Special Test Equipment (STE).

**nominated bandwidth (B<sub>n</sub>):** B<sub>n</sub> of the Mobile Earth Station (MES) radio frequency transmission is wide enough to encompass all spectral elements of the transmission which have a level greater than the specified levels of unwanted ~~emissions~~. The B<sub>n</sub> is defined relative to the MES actual carrier frequency f<sub>c</sub>.

B<sub>n</sub> is the width of the frequency interval (f<sub>c</sub> -a, f<sub>c</sub> +b), where a and b, which shall be specified by the applicant, may vary with f<sub>c</sub>.

The frequency interval (f<sub>c</sub> -a, f<sub>c</sub> +b) shall not encompass more than either:

- i) when a = b, 4 nominal carrier frequencies for narrow-band systems;
- ii) when a ≠ b, 1 nominal carrier frequency for narrow-band systems; or
- iii) 1 nominal carrier frequency for wide-band systems.

The frequency interval (f<sub>c</sub> -a, f<sub>c</sub> +b) shall be within the operational band of the MES.

**NOTE:** Explanation of nominated bandwidth is presented in annex B.

**operational band:** sub-portion of the band 1 980 MHz to 2 010 MHz which has been assigned in the earth-to-space direction to the MSS network, within which the MES is ~~operating~~.

**Portable Equipment (PE):** Portable Equipment (PE) is generally intended to be self-contained, free standing and ~~portable~~. A PE would normally consist of a single module, but may consist of several interconnected modules.

**radiated measurement:** measurement of an actual radiated ~~field~~.

**Special Test Equipment (STE):** equipment which allows a test laboratory to control the MES so that the tests required by the present document can be ~~performed~~.

**test laboratory:** laboratory which performs the conformance testing of the MES against the present document. The test laboratory may be the applicant's ~~laboratory~~.

**test load:** test load is a substantially non-reactive, non-radiating power attenuator which is capable of safely dissipating the power from the transmitter(~~s~~).

**unwanted emissions:** unwanted emissions are those falling outside the nominated bandwidth in the carrier-on state and those generated in the carrier-off ~~state~~.

**wide-band system:** wide-band system is one in which the nominal carrier frequency spacing for MESs in the earth-~~to-space direction is equal or greater than 300 kHz~~.

## 3.2 Abbreviations

For the purposes of the present document, the following abbreviations apply:

B <sub>n</sub>	nominated Bandwidth
CDMA	Code Division Multiple Access
CMF	Control and Monitoring Functions
dBW	decibel relative to 1 Watt
EIRP	Equivalent Isotropically Radiated Power

Table 2: Vibration characteristics

Frequency range	ASD (Acceleration Spectral Density) random vibration
5 Hz to 20 Hz	0,96 m <sup>2</sup> /s <sup>3</sup> (+0/-5 %)
20 Hz to 500 Hz	0,96 m <sup>2</sup> /s <sup>3</sup> (+ 0/-5 %) at 20 Hz, thereafter -3 dB/Octave (+0/-5 %) (taken from IEC Publication 60068-2-64 [5])

## 4.2 Conformance requirements

### 4.2.1 Unwanted emissions outside the band 1 980,1 MHz to 2 009,9 MHz (carrier-on)

#### 4.2.1.1 Justification

Protection of other radio services operating outside the band 1 980 MHz to 2 010 MHz from emissions caused by [S-PCN](#) MESs operating within the band 1 980,1 MHz to 2 009,9 MHz.

#### 4.2.1.2 Technical Requirement

The maximum EIRP density of the unwanted emissions from the MES outside the band 1 980,1 MHz to 2 009,9 MHz shall not exceed the limits in table 3.

In table 3, whenever a change of limit between adjacent frequency bands occurs, the lower of the two limits shall apply at the transition frequency.

Table 3: Unwanted emissions outside the band 1 980,1 MHz to 2 009,9 MHz

Frequency (MHz)	Carrier - on		
	EIRP (dBW)	Measurement bandwidth	Measurement method
0,1 to 30	-66	10 kHz	Peak hold
30 to 1 000	-66	100 kHz	Peak hold
1 000 to 1 559	-60	3 MHz	Average
1 559 to 1 626,5	-70	1 MHz	Average (over 20 ms)
1 626,5 to 1 950	-60	3 MHz	Average
1 950 to 1 960	-60	1 MHz	Average
1 960 to 1 970	-60	300 kHz	Average
1 970 to 1 975	-60	100 kHz	Average
1 975 to 1 978,1	-60	30 kHz	Average
1 978,1 to 1 980,1	The levels in table 4 for the frequency offset 0 to 2 MHz shall apply from 1 980,1 MHz to 1 978,1 MHz		
1 980,1 to 2 009,9	Not applicable	Not applicable	Not applicable
2 009,9 to 2 011,9	The levels in table 4 for the frequency offset 0 to 2 MHz shall apply from 2 009,9 MHz to 2 011,9 MHz		
2 011,9 to 2 015	-60	30 kHz	Average
2 015 to 2 020	-60	100 kHz	Average
2 020 to 2 030	-60	300 kHz	Average
2 030 to 2 040	-60	1 MHz	Average
2 040 to 2 600	-60	3 MHz	Average
2 600 to 12 750	-60	3 MHz	Peak hold

The conformance requirements apply for the full range of environmental conditions corresponding to the type of equipment as specified in [clause 4.1](#).

#### 4.2.1.3 Conformance Test

Conformance tests shall be carried out in accordance with [clause 5.2.2](#).



EMC	Electro-Magnetic Compatibility
EME	Externally Mounted Equipment
IE	Installable Equipment
IME	Internally Mounted Equipment
ITU	International Telecommunications Union
LTE	Laboratory Test Equipment
MES	Mobile Earth Station
MIC	MES unique Identification Code (within its S-PCN)
MSS	Mobile Satellite Service
NCF	Network Control Facility
PE	Portable Equipment
R&TTE	Radio and Telecommunications Terminal Equipment
RF	Radio Frequency
S-PCN	Satellite Personal Communications Network
STE	Special Test Equipment
TDMA	Time Division Multiple Access

## 4 Technical requirements specifications

### 4.1 Environmental profile

#### 4.1.1 General

The technical requirements of the present document apply under the environmental profile specified below for operation of the equipment. The equipment shall comply with all the technical requirements of the present document at all times when operating within the boundary limits of the specified operational environmental profile.

#### 4.1.2 Temperature

The MES shall fulfil all the requirements in the full temperature ranges of:

-10°C to +55°C;

taken from IEC publications 60068-2-1 [3] and 60068-2-2 [4].

#### 4.1.3 Voltage

The applicant shall declare the nominal, lower and the higher extreme voltages.

The MES shall fulfil all the requirements in the full voltage range between the extreme voltages.

#### 4.1.4 Vibration

The MES shall fulfil all the requirements when vibrated at the frequency/amplitudes given in table 2.

**Table 2: Vibration characteristics**

Frequency range	ASD (Acceleration Spectral Density) random vibration
5 Hz to 20 Hz	0,96 m <sup>2</sup> /s <sup>3</sup> (+ 0/-5 %)
20 Hz to 500 Hz	0,96 m <sup>2</sup> /s <sup>3</sup> (+ 0/-5 %) at 20 Hz, thereafter -3 dB/Octave (+0/-5 %) (taken from IEC Publication 60068-2- <del>96</del> [5])

## 4.2.2 Unwanted emissions within the bands 1 980,1 MHz to 2 009,9 MHz, 1 978,1 MHz to 1 980,1 MHz and 2 009,9 MHz to 2 011,9 MHz (carrier-on)

### 4.2.2.1 Justification

Protection of radio services and systems operating within the frequency band 1 978,1 MHz to 2 011,9 MHz from unwanted emissions caused by S-PCN MESs operating in the band 1 980,1 MHz to 2 009,9 MHz.

### 4.2.2.2 Technical Requirement

The maximum EIRP spectral density of the unwanted emissions from the MES within the band 1 978,1 MHz to 2 011,9 MHz shall not exceed the limits in tables 4 or 5, as applicable.

In tables 4 and 5, whenever a change of limit between adjacent frequency bands occurs, the lower of the two limits shall apply at the transition frequency.

When conflicts between multiple requirements exist, the more stringent requirement applies.

**Table 4: Maximum unwanted emissions within the bands 1 980,1 MHz to 2 009,9 MHz from a TDMA carrier, and maximum unwanted emissions within the bands 1 978,1 MHz to 1 980,1 MHz and 2 009,9 MHz to 2 011,9 MHz from any carrier**

Frequency offset (kHz) (note 1)	Carrier - on		
	EIRP (dBW)	Measurement bandwidth (kHz)	Measurement method
0 to 166	0 - (offset × 55/166)	3 kHz	Average
166 to 575	-55	3 kHz	Average
575 to 1 175	-60	3 kHz	Average
1 175 to 1 525	-50 - ((offset - 1 175) × 5/350)	30 kHz (note 2)	Average
1 525 to 32 000	-55	30 kHz (note 2)	Average

NOTE 1: Frequency offset is determined from edge of nominated bandwidth.  
NOTE 2: The measurement bandwidth used may be 3 kHz if the unwanted EIRP limits are reduced correspondingly.

**Table 5: Maximum unwanted emissions within the band 1 980,1 MHz to 2 009,9 MHz from a CDMA carrier**

Frequency offset (kHz) (note)	Carrier - on		
	EIRP (dBW)	Measurement bandwidth (kHz)	Measurement method
0 to 160	-35	30	Average
160 to 2 300	-35 - ((offset - 160) × 21/ 2 140)	30	Average
2 300 to 32 000	-56	30	Average

NOTE: Frequency offset is determined from the edge of nominated bandwidth.

The conformance requirements apply for the full range of environmental conditions corresponding to the type of equipment as specified in [clause 4.1](#).

### 4.2.2.3 Conformance Test

Conformance tests shall be carried out in accordance with [clause 5.2.3](#).

## 4.2.3 Unwanted emissions in carrier-off state

### 4.2.3.1 Justification

Protection of other radio services and systems from unwanted emissions caused by MESs in the carrier-off state.

## 4.2 Conformance requirements

### 4.2.1 Unwanted emissions outside the band 1 980,1 MHz to 2 009,9 MHz (carrier-on)

#### 4.2.1.1 Justification

Protection of other radio services operating outside the band 1 980 MHz to 2 010 MHz from emissions caused by ~~S-PCN~~ MESSs operating within the band 1 980,1 MHz to 2 009,9 MHz.

#### 4.2.1.2 Technical Requirement

The maximum EIRP density of the unwanted emissions from the MES outside the band 1 980,1 MHz to 2 009,9 MHz shall not exceed the limits in table 3.

In table 3, whenever a change of limit between adjacent frequency bands occurs, the lower of the two limits shall apply at the transition frequency.

**Table 3: Unwanted emissions outside the band 1 980,1 MHz to 2 009,9 MHz**

Frequency (MHz)	Carrier - on		
	EIRP (dBW)	Measurement bandwidth	Measurement method
0,1 to 30	-66	10 kHz	Peak hold
30 to 1 000	-66	100 kHz	Peak hold
1 000 to 1 559	-60	3 MHz	Average
1 559 to 1 626,5	-70	1 MHz	Average (over 20 ms)
1 626,5 to 1 950	-60	3 MHz	Average
1 950 to 1 960	-60	1 MHz	Average
1 960 to 1 970	-60	300 kHz	Average
1 970 to 1 975	-60	100 kHz	Average
1 975 to 1 978,1	-60	30 kHz	Average
1 978,1 to 1 980,1	The levels in table 4 for the frequency offset 0 to 2 MHz shall apply from 1 980,1 MHz to 1 978,1 MHz		
1 980,1 to 2 009,9	Not applicable	Not applicable	Not applicable
2 009,9 to 2 011,9	The levels in table 4 for the frequency offset 0 to 2 MHz shall apply from 2 009,9 MHz to 2 011,9 MHz		
2 011,9 to 2 015	-60	30 kHz	Average
2 015 to 2 020	-60	100 kHz	Average
2 020 to 2 030	-60	300 kHz	Average
2 030 to 2 040	-60	1 MHz	Average
2 040 to 2 600	-60	3 MHz	Average
2 600 to 12 750	-60	3 MHz	Peak hold

The conformance requirements apply for the full range of environmental conditions corresponding to the type of equipment as specified in ~~subclause~~ 4.1.

#### 4.2.1.3 Conformance Test

Conformance tests shall be carried out in accordance with ~~subclause~~ 5.2.2.

### 4.2.2 Unwanted emissions within the bands 1 980,1 MHz to 2 009,9 MHz, 1 978,1 MHz to 1 980,1 MHz and 2 009,9 MHz to 2 011,9 MHz (carrier-on)

#### 4.2.2.1 Justification

Protection of radio services and systems operating within the frequency band 1 978,1 MHz to 2 011,9 MHz from unwanted emissions caused by S-PCN MESSs operating in the band 1 980,1 MHz to 2 009,9 MHz.

### 4.2.3.2 Technical Requirement

The maximum EIRP of the unwanted emissions from the MESs in the carrier-off state shall not exceed the limits in table 6.

In table 6, whenever a change of limit between adjacent frequency bands occurs, the lower of the two limits shall apply at the transition frequency.

**Table 6: Maximum EIRP of the unwanted emissions in the carrier-off state**

Frequency (MHz)	EIRP (dBW)	Measurement bandwidth	Measurement method
0,1 to 30	-87	10 kHz	peak hold
30 to 1 000	-87	100 kHz	peak hold
1 000 to 12 750	-77	100 kHz	peak hold

The conformance requirements apply for the full range of environmental conditions corresponding to the type of equipment as specified in [clause 4.1](#).

### 4.2.3.3 Conformance Test

Conformance tests shall be carried out in accordance with [clause 5.2.4](#).

## 4.2.4 MES Control and Monitoring Functions (CMF)

### 4.2.4.1 Self-monitoring functions / Processor monitoring

#### 4.2.4.1.1 Justification

Protection of radio services and systems from uncontrolled RF transmissions from the MES.

#### 4.2.4.1.2 Technical Requirement

The MES shall incorporate a processor monitoring function for each of its processors involved in the manipulation of traffic and in control and monitoring functions.

The processor monitoring function shall detect failure of the processor hardware and software.

Not later than 1 s after any detectable fault condition occurs, the transmissions shall be suppressed (carrier-off) until the processor monitoring function has determined that all fault conditions have been cleared.

The fault conditions which cause transmission shutdown shall be specified by the applicant and declared by the applicant.

The conformance requirements apply for the environmental conditions as specified in [clause 4.1](#).

#### 4.2.4.1.3 Conformance Test

Conformance tests shall be carried out in accordance with [clause 5.2.5.1](#).

### 4.2.4.2 Self-monitoring functions / Transmit frequency generation sub-system monitoring

#### 4.2.4.2.1 Justification

Protection of radio services and systems from uncontrolled RF transmissions from the MES.

#### 4.2.2.2 Technical Requirement

The maximum EIRP spectral density of the unwanted emissions from the MES within the band 1 978,1 MHz to 2 011,9 MHz shall not exceed the limits in tables 4 or 5, as applicable.

In ~~the~~ tables 4 and 5, whenever a change of limit between adjacent frequency bands occurs, the lower of the two limits shall apply at the transition frequency.

When conflicts between multiple requirements exist, the more stringent requirement applies.

**Table 4: Maximum unwanted emissions within the bands 1 980,1 MHz to 2 009,9 MHz from a TDMA carrier, and maximum unwanted emissions within the bands 1 978,1 MHz to 1 ~~980 MHz,~~ and 2 009,9 MHz to 2 011,9 MHz from any carrier**

Frequency offset (kHz) (note 1)	Carrier - on		
	EIRP (dBW)	Measurement bandwidth (kHz)	Measurement method
0 to 166	$0 - (\text{offset} \times 55/166)$	3 kHz	Average
166 to 575	-55	3 kHz	Average
575 to 1 175	-60	3 kHz	Average
1 175 to 1 525	$-50 - ((\text{offset} - 1 175) \times 5/350)$	30 kHz (note 2)	Average
1 525 to 32 000	-55	30 kHz (note 2)	Average

NOTE 1: Frequency offset is determined from edge of nominated bandwidth.  
NOTE 2: The measurement bandwidth used may be 3 kHz if the unwanted EIRP limits are reduced correspondingly.

**Table 5: Maximum unwanted emissions within the band 1 980,1 MHz to 2 009,9 MHz from a CDMA carrier**

Frequency offset (kHz) (note)	Carrier - on		
	EIRP (dBW)	Measurement bandwidth (kHz)	Measurement method
0 to 160	-35	30	Average
160 to 2 300	$-35 - ((\text{offset} - 160) \times 21/ 2 140)$	30	Average
2 300 to 32 000	-56	30	Average

NOTE: Frequency offset is determined from the edge of nominated bandwidth.

The conformance requirements apply for the full range of environmental conditions corresponding to the type of equipment as specified in ~~subclause~~ 4.1.

#### 4.2.2.3 Conformance Test

Conformance tests shall be carried out in accordance with ~~subclause~~ 5.2.3.

### 4.2.3 Unwanted emissions in carrier-off state

#### 4.2.3.1 Justification

Protection of other radio services and systems from unwanted emissions caused by MESs in the carrier-off state.

#### 4.2.3.2 Technical Requirement

The maximum EIRP of the unwanted emissions from the MESs in the carrier-off state shall not exceed the limits in table 6.

In table 6, whenever a change of limit between adjacent frequency bands occurs, the lower of the two limits shall apply at the transition frequency.

#### 4.2.4.2.2 Technical Requirement

The MES shall incorporate a transmit frequency generation sub-system monitoring function.

Not later than 5 s after any detectable failure of the transmit frequency generation sub-system occurs, the transmissions shall be suppressed (carrier-off) until the transmit frequency generation sub-system monitoring function has determined that all fault conditions have been cleared.

The fault conditions which cause transmission shutdown shall be specified by the applicant and declared by the applicant.

The conformance requirements apply for the environmental conditions as specified in [clause 4.1](#).

#### 4.2.4.2.3 Conformance Test

Conformance tests shall be carried out in accordance with [clause 5.2.5.2](#).

#### 4.2.4.3 Network control authorization

##### 4.2.4.3.1 Justification

Protection of radio services and systems from uncontrolled RF transmissions from the MES.

##### 4.2.4.3.2 Technical Requirement

During POWER-ON no transmissions shall occur from the MES.

Following POWER-ON the MES shall enter a controlled, non-transmitting (carrier-off) state. This state shall be maintained whilst the MES is not synchronized with the appropriate network control channel(s).

Without synchronizing to the appropriate network control channel(s), it shall not be possible to initiate carrier-on state.

Within 30 s of having lost the appropriate network control channel(s) the MES shall suppress transmissions (carrier-off).

The conformance requirements apply for the environmental conditions as specified in [clause 4.1](#).

##### 4.2.4.3.3 Conformance Test

Conformance tests shall be carried out in accordance with [clause 5.2.5.3](#).

#### 4.2.4.4 Network control reception

##### 4.2.4.4.1 Transmit frequency control

###### 4.2.4.4.1.1 Justification

Protection of radio services and systems from uncontrolled RF transmissions from the MES.

###### 4.2.4.4.1.2 Technical Requirement

The MES shall set the carrier frequency of its transmission according to the command of the NCF. The carrier frequency has to be controlled such, that the entire nominated bandwidth of the terminal falls completely within the operational frequency band(s) specified by the applicant and declared by the applicant.

The conformance requirements apply for the environmental conditions as specified in [clause 4.1](#).

###### 4.2.4.4.1.3 Conformance Test

Conformance tests shall be carried out in accordance with [clause 5.2.5.4.1](#).

**Table 6: Maximum EIRP of the unwanted emissions in the carrier-off state**

Frequency (MHz)	EIRP (dBW)	Measurement bandwidth	Measurement method
0,1 to 30	-87	10 kHz	peak hold
30 to 1 000	-87	100 kHz	peak hold
1 000 to 12 750	-77	100 kHz	peak hold

The conformance requirements apply for the full range of environmental conditions corresponding to the type of equipment as specified in ~~subclause~~ 4.1.

#### 4.2.3.3 Conformance Test

Conformance tests shall be carried out in accordance with ~~subclause~~ 5.2.4.

### 4.2.4 MES Control and Monitoring Functions (CMF)

#### 4.2.4.1 Self-monitoring functions / Processor monitoring

##### 4.2.4.1.1 Justification

Protection of radio services and systems from uncontrolled RF transmissions from the MES.

##### 4.2.4.1.2 Technical Requirement

The MES shall incorporate a processor monitoring function for each of its processors involved in the manipulation of traffic and in control and monitoring functions.

The processor monitoring function shall detect failure of the processor hardware and software.

Not later than 1 s after any detectable fault condition occurs, the transmissions shall be suppressed (carrier-off) until the processor monitoring function has determined that all fault conditions have been cleared.

The fault conditions which cause transmission shutdown shall be specified by the applicant and declared by the applicant.

The conformance requirements apply for the environmental conditions as specified in ~~subclause~~ 4.1.

##### 4.2.4.1.3 Conformance Test

Conformance tests shall be carried out in accordance with ~~subclause~~ 5.2.5.1.

#### 4.2.4.2 Self-monitoring functions / Transmit frequency generation sub-system monitoring

##### 4.2.4.2.1 Justification

Protection of radio services and systems from uncontrolled RF transmissions from the MES.

##### 4.2.4.2.2 Technical Requirement

The MES shall incorporate a transmit frequency generation sub-system monitoring function.

Not later than 5 s after any detectable failure of the transmit frequency generation sub-system occurs, the transmissions shall be suppressed (carrier-off) until the transmit frequency generation sub-system monitoring function has determined that all fault conditions have been cleared.

The fault conditions which cause transmission shutdown shall be specified by the applicant and declared by the applicant.

#### 4.2.4.5 Fellow radio stations in a dual-mode or multi-mode terminal

##### 4.2.4.5.1 Justification

Protection of radio services and systems from uncontrolled RF transmissions from the MES.

##### 4.2.4.5.2 Technical Requirement

Any fellow radio station in a multi-mode MES shall not transmit without reception of a network control channel for the system for which it is designed.

The conformance requirements apply for the environmental conditions as specified for the fellow radio station.

##### 4.2.4.5.3 Conformance Test

Conformance tests shall be carried out in accordance with [clause 5.2.5.5](#).

### 4.2.5 Equipment identity

#### 4.2.5.1 Justification

Protection of radio services and systems from uncontrolled RF transmissions from the MES.

#### 4.2.5.2 Technical Requirement

Each MES shall have a unique MES Identification Code (MIC) within its S-PCN.

It shall not be possible for the user to alter the MIC using any normally accessible procedure.

The MES shall be capable of transmitting its identification code upon reception of an appropriate NCF command addressed to it.

The conformance requirements apply for the environmental conditions as specified in [clause 4.1](#).

#### 4.2.5.3 Conformance Test

Conformance tests shall be carried out in accordance with [clause 5.2.6](#).

---

## 5 Testing for compliance with technical requirements

### 5.1 Environmental conditions for testing

#### 5.1.1 Specification of the environmental test conditions

The tests in [clauses 5.2.2, 5.2.3 and 5.2.4](#) shall be performed under the conditions given in table 7.

**Table 7: Environmental test conditions**

Equipment Category	Temperature	Voltage
Handheld	Normal	Normal condition voltage ( $\pm 1$ %)
other than handheld	Normal	Higher extreme voltage (+0/-2 %)
other than handheld	Normal	Lower extreme voltage (-0/+2 %)

Normal temperature shall be between +15 °C and +35 °C.

All other tests shall be performed under normal conditions for temperature and voltage, and without vibration.



The conformance requirements apply for the environmental conditions as specified in ~~subclause~~ 4.1.

#### 4.2.4.2.3 Conformance Test

Conformance tests shall be carried out in accordance with ~~subclause~~ 5.2.5.2.

#### 4.2.4.3 Network control authorization

##### 4.2.4.3.1 Justification

Protection of radio services and systems from uncontrolled RF transmissions from the MES.

##### 4.2.4.3.2 Technical Requirement

During POWER-ON no transmissions shall occur from the MES.

Following POWER-ON the MES shall enter a controlled, non-transmitting (carrier-off) state. This state shall be maintained whilst the MES is not synchronized with the appropriate network control channel(s).

Without synchronizing to the appropriate network control channel(s), it shall not be possible to initiate carrier-on state.

Within 30 s of having lost the appropriate network control channel(s) the MES shall suppress transmissions (carrier-off).

The conformance requirements apply for the environmental conditions as specified in ~~subclause~~ 4.1.

#### 4.2.4.3.3 Conformance Test

Conformance tests shall be carried out in accordance with ~~subclause~~ 5.2.5.3.

#### 4.2.4.4 Network control reception

##### 4.2.4.4.1 Transmit frequency control

###### 4.2.4.4.1.1 Justification

Protection of radio services and systems from uncontrolled RF transmissions from the MES.

###### 4.2.4.4.1.2 Technical Requirement

The MES shall set the carrier frequency of its transmission according to the command of the NCF. The carrier frequency has to be controlled such, that the entire nominated bandwidth of the terminal falls completely within the operational frequency band(s) specified by the applicant and declared by the applicant.

The conformance requirements apply for the environmental conditions as specified in ~~subclause~~ 4.1.

###### 4.2.4.4.1.3 Conformance Test

Conformance tests shall be carried out in accordance with ~~subclause~~ 5.2.5.4.1.

#### 4.2.4.5 Fellow radio stations in a dual-mode or multi-mode terminal

##### 4.2.4.5.1 Justification

Protection of radio services and systems from uncontrolled RF transmissions from the MES.

##### 4.2.4.5.2 Technical Requirement

Any fellow radio station in a multi-mode MES shall not transmit without reception of a network control channel for the system for which it is designed.

## 5.1.2 Tests under extreme voltage conditions

During tests under extreme voltage conditions, the power source of the equipment shall be replaced by a test power source, capable of producing extreme test voltages as specified in [clause 5.1.1](#). The internal impedance of the test power source shall be low enough for its effect on the test results to be negligible. For the test purposes, the voltage of the power source shall be measured at the input terminals of the equipment.

If the equipment is provided with a permanently connected power cable, the test voltage shall be measured at the point of connection of the power cable to the equipment.

In equipment with incorporated batteries, the test power source shall be applied as close to the battery terminals as is practical. In each case connections shall be made readily available by the applicant.

During tests, the power source voltages shall be maintained within a tolerance of  $\pm 3$  % relative to the voltage at the beginning of each test.

## 5.2 Essential radio test suites

### 5.2.1 General

#### 5.2.1.1 Presentation of equipment for testing purposes

The applicant may provide to a test laboratory one or more preliminary or production models of the MES equipment, as appropriate, for testing for conformance against the technical requirements of the present document.

If the MES is intended for use with an active antenna, this shall be provided as part of the MES.

If a statement of conformance with the EN is given by the test laboratory on the basis of tests on a preliminary model, then the statement of conformance shall apply to corresponding production models only if they are identical in all technical respects with the preliminary model tested.

#### 5.2.1.2 Description of equipment

The applicant shall provide to the test laboratory a statement which contains all of the information related to the MES and its testing environment which will enable the test laboratory to run an appropriate test suite against the MES.

This shall include:

- self contained or host-connected;
- single-mode or multi-mode;
- antenna:
  - active; or
  - passive, with an antenna port available; or
  - passive, no antenna port available.

NOTE 1: If the MES has an active antenna, the antenna is regarded as an integral part of the MES.

NOTE 2: If the MES is intended for use with a passive antenna, the maximum gain of any antenna intended to be used with the equipment is to be stated.

- the method by which the equipment can be switched into its test modes;

NOTE 3: If Special Test Equipment (STE) is required see [clause 5.2.1.4](#) and [clause 5.2.1.5.2](#).

- the fault conditions which cause transmission shut-down;
- the nominal, the lower extreme and the higher extreme operational voltages;

The conformance requirements apply for the environmental conditions as specified for the fellow radio station.

#### 4.2.4.5.3 Conformance Test

Conformance tests shall be carried out in accordance with ~~subclause~~ 5.2.5.5.

### 4.2.5 Equipment identity

#### 4.2.5.1 Justification

Protection of radio services and systems from uncontrolled RF transmissions from the MES.

#### 4.2.5.2 Technical Requirement

Each MES shall have a unique MES Identification Code (MIC) within its S-PCN.

It shall not be possible for the user to alter the MIC using any normally accessible procedure.

The MES shall be capable of transmitting its identification code upon reception of an appropriate NCF command addressed to it.

The conformance requirements apply for the environmental conditions as specified in ~~subclause~~ 4.1.

#### 4.2.5.3 Conformance Test

Conformance tests shall be carried out in accordance with ~~subclause~~ 5.2.6.

## 5 Testing for compliance with technical requirements

### 5.1 Environmental conditions for testing

#### 5.1.1 Specification of the environmental test conditions

The tests in ~~subclauses~~ 5.2.2, 5.2.3 and 5.2.4 shall be performed under the conditions given in table 7.

**Table 7: Environmental test conditions**

Equipment Category	Temperature	Voltage
Handheld	Normal	Normal condition voltage ( $\pm 1$ %)
other than handheld	Normal	Higher extreme voltage (+0/-2 %)
other than handheld	Normal	Lower extreme voltage (-0/+2 %)

Normal temperature shall be between +15°C and +35°C.

All other tests shall be performed under normal conditions for temperature and voltage, and without vibration.

#### 5.1.2 Tests under extreme voltage conditions

During tests under extreme voltage conditions, the power source of the equipment shall be replaced by a test power source, capable of producing extreme test voltages as specified in ~~subclause~~ 5.1.1. The internal impedance of the test power source shall be low enough for its effect on the test results to be negligible. For the test purposes, the voltage of the power source shall be measured at the input terminals of the equipment.

If the equipment is provided with a permanently connected power cable, the test voltage shall be measured at the point of connection of the power cable to the equipment.

- in the case of a multi-mode MES, the other modes of operation;
- if the conducted emission measurements are to be performed:
  - the gain at the frequency of the measured spurious emission, according to the choice of the applicant.
- in an information leaflet, for each S-PCN for which the MES is designed to operate:
  - 1) the name of the S-PCN;
  - 2) the maximum value of nominated bandwidth for that S-PCN, as defined by the network operator;
  - 3) the a and b values of the nominated bandwidth for each nominal carrier frequency of the MES;
  - 4) the operating frequency range(s) of the MES;
  - 5) the frequency sub-bands and operating conditions for which the different EIRP density limits apply;
  - 6) the maximum gross data rate at which the MES is designed to operate;
  - 7) the agreement of the network operator to the above information.

### 5.2.1.3 Testing of host-connected equipment and plug-in modules

#### 5.2.1.3.1 Alternative approaches

For equipment for which connection to or integration with host equipment is required to offer functionality, two alternative approaches are permitted. The applicant shall decide which alternative shall be used.

#### 5.2.1.3.2 Alternative A: combined equipment

Under alternative A, a combination of MES and a specific type of host equipment shall be used for testing according to the present document.

Where more than one such combination is intended, testing shall not be repeated for combinations of MES and other host equipment where the latter are substantially similar, in particular such that the host models are unlikely to significantly influence the emissions of the MES.

Where more than one such combination is intended and host equipment are not substantially similar, one combination shall be tested against the full set of requirements of the present document; other combinations shall be tested separately for radiated emissions only.

#### 5.2.1.3.3 Alternative B: use of a test jig

Under alternative B, where the MES is intended for use with a variety of host equipment, the applicant shall supply a suitable test jig that is representative of the range of host equipment in which the MES may be used. In particular, the test jig shall be designed such that any alteration of the MES's emissions is minimized. The test jig shall allow the MES part to be powered and stimulated in a way similar to the way it would be powered and stimulated when connected to or inserted into the host equipment.

The MES shall be tested against the full set of requirements of the present document.

#### 5.2.1.4 CMF / Special Test Equipment (STE)

The STE shall provide the necessary facilities for tests which require that the MES be operated in its normal operating manner, situated in an environment where receipt of a network control channel and of NCF commands is under the control of the test laboratory.

This STE shall provide the means to generate and to communicate to the MES, either radiated via its antenna or conducted via direct connection to its antenna port, the network control channel and the required NCF commands, under the control of the test laboratory.

The STE shall also provide means for the test laboratory to interface its test equipment with the MES for the purpose of monitoring the MES responses.

In equipment with incorporated batteries, the test power source shall be applied as close to the battery terminals as is practical. In each case connections shall be made readily available by the applicant.

During tests, the power source voltages shall be maintained within a tolerance of  $\pm 3$  % relative to the voltage at the beginning of each test.

## 5.2 Essential radio test suites

### 5.2.1 General

#### 5.2.1.1 Presentation of equipment for testing purposes

The applicant may provide to a test laboratory one or more preliminary or production models of the MES equipment, as appropriate, for testing for conformance against the technical requirements of the present document.

If the MES is intended for use with an active antenna, this shall be provided as part of the MES.

If a statement of conformance with the EN is given by the test laboratory on the basis of tests on a preliminary model, then the statement of conformance shall apply to corresponding production models only if they are identical in all technical respects with the preliminary model tested.

#### 5.2.1.2 Description of equipment

The applicant shall provide to the test laboratory a statement which contains all of the information related to the MES and its testing environment which will enable the test laboratory to run an appropriate test suite against the MES.

This shall include:

- self contained or host-connected;
- single-mode or multi-mode;
- antenna:
  - active; or
  - passive, with an antenna port available; or
  - passive, no antenna port available.

NOTE 1: If the MES has an active antenna, the antenna is regarded as an integral part of the MES.

NOTE 2: If the MES is intended for use with a passive antenna, the maximum gain of any antenna intended to be used with the equipment is to be stated.

- the method by which the equipment can be switched into its test modes;

NOTE 3: If Special Test Equipment (STE) is required see ~~subclause 5.2.1.4~~ and ~~subclause 5.2.1.5.2~~.

- the fault conditions which cause transmission shut-down;
- the nominal, the lower extreme and the higher extreme operational voltages;
- in the case of a multi-mode MES, the other modes of operation;
- if the conducted emission measurements are to be performed:
  - the gain at the frequency of the measured spurious emission, according to the choice of the applicant.
- in an information leaflet, for each S-PCN for which the MES is designed to operate:
  - 1) the name of the S-PCN;

For other tests, where the required test mode cannot be, or is not, provided by a special test facility within the MES, then STE shall also provide the facility to put the MES into these required test modes.

This will require the provision either by the applicant, or the manufacturer, of Special Test Equipment.

## 5.2.1.5 General test requirements

### 5.2.1.5.1 MES test modes

The MES is required to be placed in a number of different test modes in order for the various tests specified within the present document to be carried out:

- 1) power-off;
- 2) power-on (applies to all the following test modes);
- 3) carrier-off;
- 4) carrier-on, maximum transmit power, in a specified channel in an operational band, modulated with the test modulating signal;
- 5) carrier-on, maximum transmit power, in a specified channel in an operational band, set by NCF command, modulated with the test modulating signal (Note: if this is available for all tests, mode 4 is not required separately);
- 6) carrier-on (detectable).

The MES may be placed into test modes 4 and 5 either by means of a special facility existing internally in the MES, or by means of a Special Test Equipment (STE).

If the MES has been modified by the applicant for these tests, then full documentation showing such modification(s) shall be provided to demonstrate that the modification(s) will not cause the test results to deviate from normal operational performance.

### 5.2.1.5.2 Special Test Equipment

#### 5.2.1.5.2.1 Use of STE for control and monitoring functions tests

The test arrangement shall be as shown in figure 1 for radiated and conducted measurements.

This test arrangement assumes that the STE is responsible for simulating for the MES the NCF commands or network control channel in the same way as they are received by the MES in normal operating mode. The response received by the STE from the MES shall be routed to the LTE without modification that would significantly affect the measurement.

- 2) the maximum value of nominated bandwidth for that S-PCN, as defined by the network operator;
- 3) the a and b values of the nominated bandwidth for each nominal carrier frequency of the MES;
- 4) the operating frequency range(s) of the MES;
- 5) the frequency sub-bands and operating conditions for which the different EIRP density limits apply;
- 6) the maximum gross data rate at which the MES is designed to operate;
- 7) the agreement of the network operator to the above information.

### 5.2.1.3 Testing of host-connected equipment and plug-in modules

#### 5.2.1.3.1 Alternative approaches

For equipment for which connection to or integration with host equipment is required to offer functionality, two alternative approaches are permitted. The applicant shall decide which alternative shall be used.

#### 5.2.1.3.2 Alternative A: combined equipment

Under alternative A, a combination of MES and a specific type of host equipment shall be used for testing according to the present document.

Where more than one such combination is intended, testing shall not be repeated for combinations of MES and other host equipment where the latter are substantially similar, in particular such that the host models are unlikely to significantly influence the emissions of the MES.

Where more than one such combination is intended and host equipment are not substantially similar, one combination shall be tested against the full set of requirements of the present document; other combinations shall be tested separately for radiated emissions only.

#### 5.2.1.3.3 Alternative B: use of a test jig

Under alternative B, where the MES is intended for use with a variety of host equipment, the applicant shall supply a suitable test jig that is representative of the range of host equipment in which the MES may be used. In particular, the test jig shall be designed such that any alteration of the MES's emissions is minimized. The test jig shall allow the MES part to be powered and stimulated in a way similar to the way it would be powered and stimulated when connected to or inserted into the host equipment.

The MES shall be tested against the full set of requirements of the present document.

#### 5.2.1.4 CMF / Special Test Equipment (STE)

The STE shall provide the necessary facilities for tests which require that the MES be operated in its normal operating manner, situated in an environment where receipt of a network control channel and of NCF commands is under the control of the test laboratory.

This STE shall provide the means to generate and to communicate to the MES, either radiated via its antenna or conducted via direct connection to its antenna port, the network control channel and the required NCF commands, under the control of the test laboratory.

The STE shall also provide means for the test laboratory to interface its test equipment with the MES for the purpose of monitoring the MES responses.

For other tests, where the required test mode cannot be, or is not, provided by a special test facility within the MES, then STE shall also provide the facility to put the MES into these required test modes.

This will require the provision either by the applicant, or the manufacturer, of Special Test Equipment.

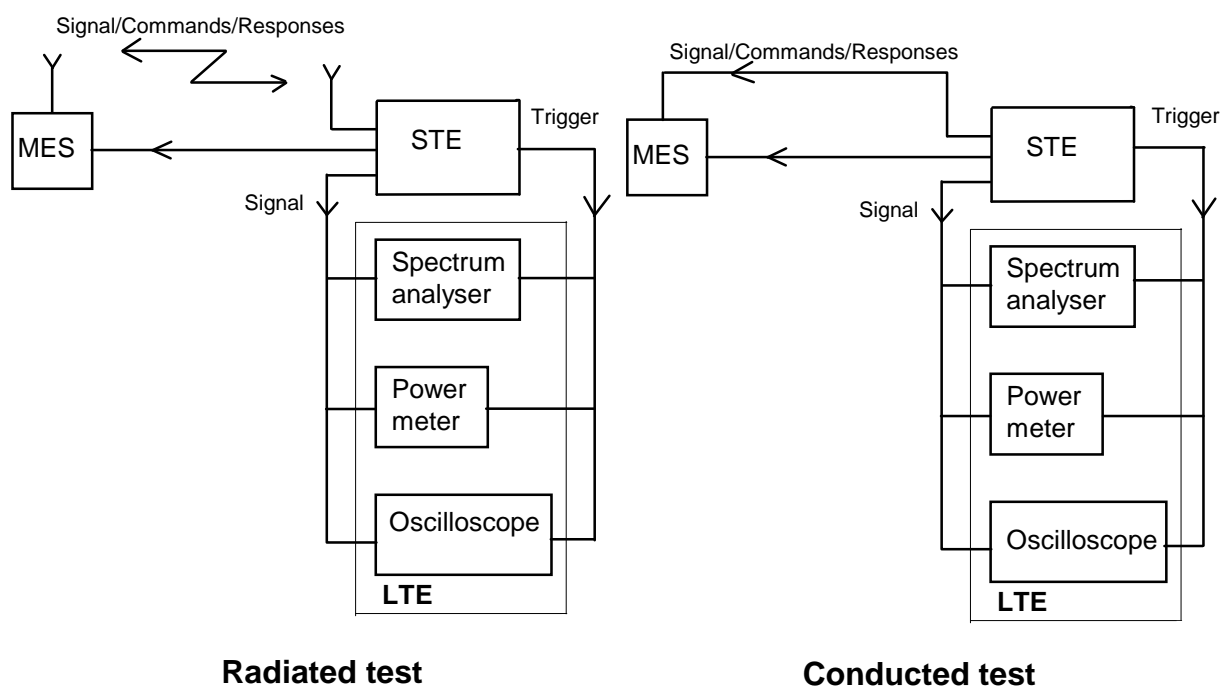

**Figure 1: General test arrangement for control and monitoring tests**

The dual trace storage oscilloscope, or other suitable method, may be used to monitor the response of the MES to the simulated events by measuring the time difference between the event or command reception, and the compliance with that event.

The power meter and spectrum analyzer shall be used to monitor the MES output signal during all the test procedure.

#### 5.2.1.5.2.2 Test modulating signal

The test modulating signal is a baseband signal which modulates the carrier of the MES and is dependent upon the type of equipment under test. It is a signal representing a pseudorandom bit sequence of at least 511 bits in accordance with ITU-T Recommendation O.153 [2]. This sequence shall be continuously repeated and shall be at the maximum bit rate declared by the applicant at which the MES is able to operate.

If not internally generated by the MES, this test modulating signal shall be provided by the STE.

#### 5.2.1.5.3 Laboratory Test Equipment (LTE)

The Laboratory Test Equipment (LTE) is a logical grouping that contains the measurement equipment provided by the test laboratory.

It shall be verified that the responses of the LTE, including any test antenna, to a constant amplitude sine wave signal remain within  $\pm 1$  dB of calibration across the frequency range of interest.

The maximum values of measurement uncertainty for the LTE associated with each measurement parameter given in table 8 for a 95 % confidence level, shall apply as appropriate to the test cases described in the present document.

**Table 8: Measurement uncertainties**

Measured parameter	Measurement uncertainty
Radio Frequency above 1 MHz	$\pm 1$ part in $10^7$
EIRP density within the operational band	$\pm 0,75$ dB
Unwanted radiated emissions	$\pm 6$ dB
Unwanted conducted emissions	$\pm 4$ dB



## 5.2.1.5 General test requirements

### 5.2.1.5.1 MES test modes

The MES is required to be placed in a number of different test modes in order for the various tests specified within the present document to be carried out:

- 1) power-off;
- 2) power-on (applies to all the following test modes);
- 3) carrier-off;
- 4) carrier-on, maximum transmit power, in a specified channel in an operational band, modulated with the test modulating signal;
- 5) carrier-on, maximum transmit power, in a specified channel in an operational band, set by NCF command, modulated with the test modulating signal (Note: if this is available for all tests, mode 4 is not required separately);
- 6) carrier-on (detectable).

The MES may be placed into test modes 4 and 5 either by means of a special facility existing internally in the MES, or by means of a Special Test Equipment (STE).

If the MES has been modified by the applicant for these tests, then full documentation showing such modification(s) shall be provided to demonstrate that the modification(s) will not cause the test results to deviate from normal operational performance.

### 5.2.1.5.2 Special Test Equipment

#### 5.2.1.5.2.1 Use of STE for control and monitoring functions tests

The test arrangement shall be as shown in figure 2 for radiated and conducted measurements.

This test arrangement assumes that the STE is responsible for simulating for the MES the NCF commands or network control channel in the same way as they are received by the MES in normal operating mode. The response received by the STE from the MES shall be routed to the LTE without modification that would significantly affect the measurement.

#### 5.2.1.5.4 Method of test for MES RF emissions according to equipment type

Measurements shall be performed according to the equipment type.

**Table 9: Options for testing**

Equipment with passive antenna port available (external, internal or temporary)	Radiated from cabinet from 30 MHz to 4 GHz (passive antenna port connected to a dummy load), and conducted from the passive antenna port, from 100 kHz to 12,75 GHz
Equipment with no passive antenna port available	Radiated from complete MES, including its antenna, from 30 MHz to 12,75 GHz

The methods of measurement for radiated emissions are described in clause 5.2.1.5.5.

The methods of measurement for conducted emissions are described in clause 5.2.1.5.6.

#### 5.2.1.5.5 Procedures for measurement of MES RF radiated emissions

##### 5.2.1.5.5.1 General

Clause 5.2.1.5.5 contains methods for tests involving the measurement of a radiated field. This field may be radiated by an antenna and/or by the cabinet of the equipment itself.

It is recognized that for some parameters, alternative test methods may exist. It is the responsibility of the test laboratory to ensure that any alternative test method used yields results identical to those described in the present document.

##### 5.2.1.5.5.1.1 Test site

The standard test site shall be a calibrated open air test site, whose dimensions are appropriate to the frequency range of measurements.

All radiated measurement tests shall be conducted in such a way as to ensure that there is no interference to operational satellite and terrestrial systems. In some cases operating on a test site may produce electromagnetic perturbation or, conversely, external radiation may disturb the measurement. For these reasons, and also in order to reduce the space required, or to perform tests under extreme environmental conditions, other arrangements may be used, such as:

- anechoic chamber;
- indoor test site.

In addition, it shall be verified that the test site shall be suitable with respect to ambient noise which shall be at least 6 dB lower than the lowest specification value being measured.

The methods of measurement described in this clause are based on an open air test site. If an anechoic chamber or an indoor test site are used, some changes may apply to the method of measurement. For each radiated measurement, the nature and the dimensions of the test arrangement used shall be recorded in the test report.

##### 5.2.1.5.5.1.2 Test set up for radiated emissions of the MES

The tests shall be carried out with the MES at the specified environmental conditions and for the specified power supply voltages.

For IE, EME and IME it shall be installed with a separation of approximately 0,5 m. Between the two equipment, the maximum length connection cable specified by the applicant shall be installed. The height of the cable shall be between 0,5 m and 1 m. The cable shall be maintained in that position by non-metallic means. The EME shall be set, in its normal operating configuration on a non-conducting support at a height between 0,5 m and 1 m. The IME shall be set on a non-conducting support at a height between 0,5 m and 1 m. Any associated equipment, if required for normal operation of the MES, shall be placed next to, and at the same height as the IME.

For PE, the equipment shall be arranged in its normal operating configuration as recommended by the applicant on a non-metallic table at a height between 0,5 m and 1 m.

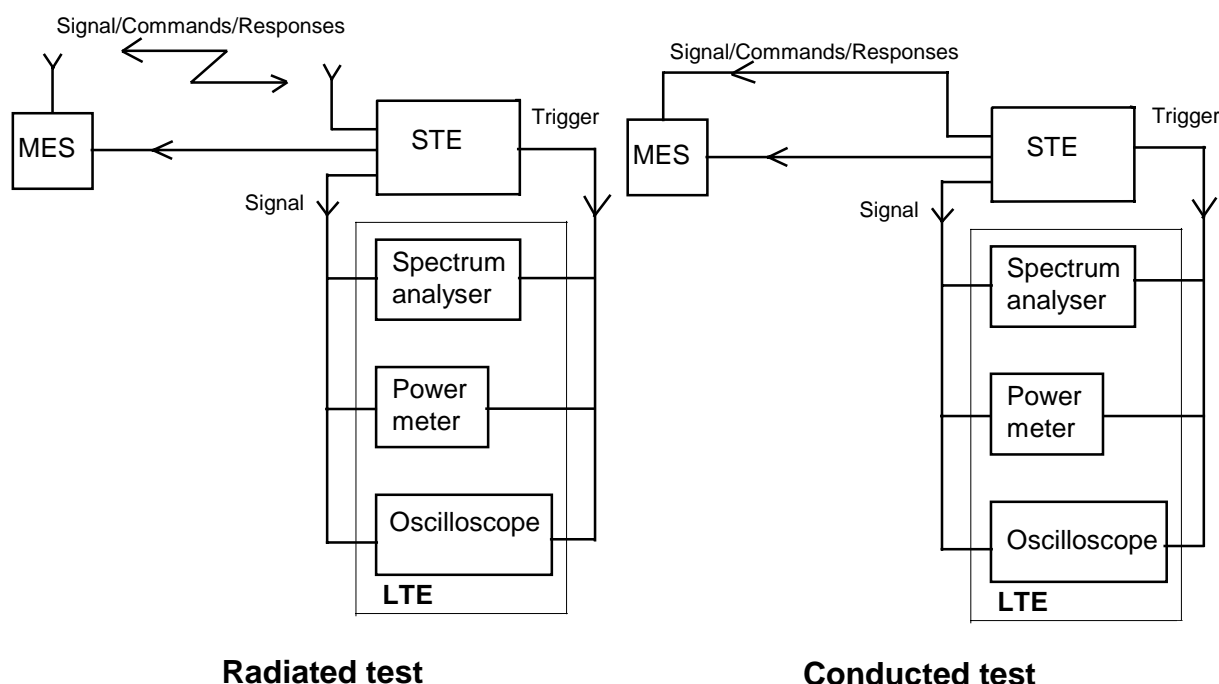

Radiated test

Conducted test

**Figure 2: General test arrangement for control and monitoring tests**

The dual trace storage oscilloscope, or other suitable method, may be used to monitor the response of the MES to the simulated events by measuring the time difference between the event or command reception, and the compliance with that event.

The power meter and spectrum analyzer shall be used to monitor the MES output signal during all the test procedure.

#### 5.2.1.5.2.2 Test modulating signal

The test modulating signal is a baseband signal which modulates the carrier of the MES and is dependent upon the type of equipment under test. It is a signal representing a pseudorandom bit sequence of at least 511 bits in accordance with ~~CCITT~~ Recommendation O.153 [2]. This sequence shall be continuously repeated and shall be at the maximum bit rate declared by the applicant at which the MES is able to operate.

If not internally generated by the MES, this test modulating signal shall be provided by the STE.

#### 5.2.1.5.3 Laboratory Test Equipment (LTE)

The Laboratory Test Equipment (LTE) is a logical grouping that contains the measurement equipment provided by the test laboratory.

It shall be verified that the responses of the LTE, including any test antenna, to a constant amplitude sine wave signal remain within  $\pm 1$  dB of calibration across the frequency range of interest.

The maximum values of measurement uncertainty for the LTE associated with each measurement parameter given in table 8 for a 95 % confidence level, shall apply as appropriate to the test cases described in the present document.

**Table 8: Measurement uncertainties**

Measured parameter	Measurement uncertainty
Radio Frequency above 1 MHz	$\pm 1$ part in <del>10</del>
EIRP density within the operational band	$\pm 0,75$ dB
Unwanted radiated emissions	$\pm 6$ dB
Unwanted conducted emissions	$\pm 4$ dB

The MES under test shall be placed on the support in its standard position and shall be switched-on.

Each antenna (MES antenna and test antenna) shall be positioned to be outside the near field of the other antenna.

The spectrum analyzer noise floor shall be at least 6 dB below the minimum value to be measured.

#### 5.2.1.5.5.1.3 Reference position of the MES

During radiated measurements, the MES is required to be oriented specifically in relation to the test antenna connected to the LTE. This position is called the reference position and is determined as follows:

- the MES shall be placed in a mode whereby it is transmitting;
- the MES shall be rotated in both horizontal and vertical planes in order to locate the direction of maximum field strength that is detected by the test antenna. This orientation shall be called the reference position.

#### 5.2.1.5.5.2 Measurement procedure for radiated emissions (peak)

##### 5.2.1.5.5.2.1 Measurement procedure for peak radiated emissions of the MES

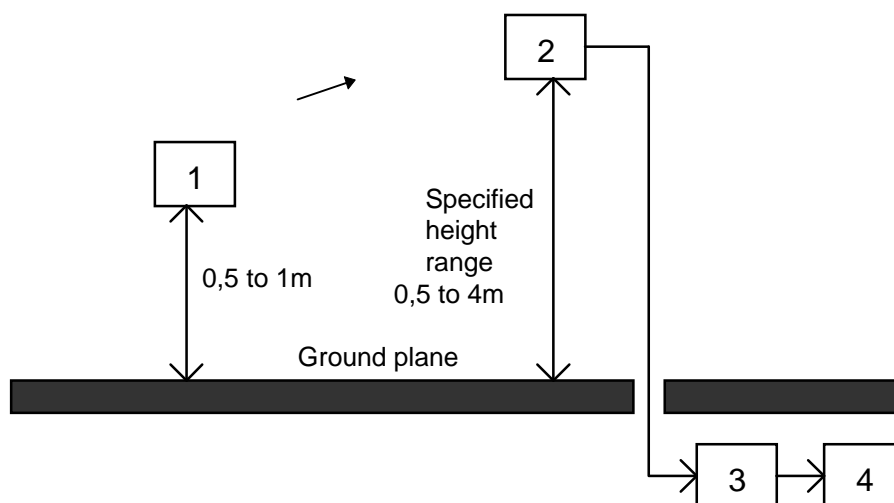

- 1) MES under test (with antenna).
- 2) Test antenna.
- 3) Input filter (if necessary).
- 4) Spectrum analyzer.

**Figure 2: Measurement arrangement number 1**

Measurement arrangement number 1 of figure 2 shall be used.

- a) For each measurement bandwidth, the following actions shall be performed:
  - the MES shall be placed in the reference position as described in clause 5.2.1.5.5.1.3;
  - the test antenna shall have the same polarization as the MES and connected to a spectrum analyzer, eventually through a suitable entry filter to avoid overloading of the spectrum analyzer;
  - precautions may be required to ensure that the filter does not attenuate the harmonics of the carrier;
  - the test antenna and the entry filter shall be suitable for the measured frequency band, and replaced by other each time it will be necessary;
  - the spectrum analyzer shall be tuned to the measurement bandwidth to analyse;
  - the resolution bandwidth of the spectrum analyzer shall be set to a suitable value to correctly perform the measurement, and the peak hold function shall be activated. The video bandwidth shall be set to at least 3 times the resolution bandwidth.

#### 5.2.1.5.4 Method of test for MES RF emissions according to equipment type

Measurements shall be performed according to the equipment ~~type~~.

**Table 9: Options for testing**

Equipment with passive antenna port available (external, internal or temporary)	Radiated from cabinet from 30 MHz to 4 GHz (passive antenna port connected to a dummy load), and conducted from the passive antenna port, from 100 kHz to 12,75 GHz
Equipment with no passive antenna port available	Radiated from complete MES, including its antenna, from 30 MHz to 12,75 GHz

The methods of measurement for radiated emissions are described in ~~subclause~~ 5.2.1.5.5.

The methods of measurement for conducted emissions are described in ~~subclause~~ 5.2.1.5.6.

#### 5.2.1.5.5 Procedures for measurement of MES RF radiated emissions

##### 5.2.1.5.5.1 General

~~Subclause~~ 5.2.1.5.5 contains methods for tests involving the measurement of a radiated field. This field may be radiated by an antenna and/or by the cabinet of the equipment itself.

It is recognized that for some parameters, alternative test methods may exist. It is the responsibility of the test laboratory to ensure that any alternative test method used yields results identical to those described in the present document.

##### 5.2.1.5.5.1.1 Test site

The standard test site shall be a calibrated open air test site, whose dimensions are appropriate to the frequency range of measurements.

All radiated measurement tests shall be conducted in such a way as to ensure that there is no interference to operational satellite and terrestrial systems. In some cases operating on a test site may produce electromagnetic perturbation or, conversely, external radiation may disturb the measurement. For these reasons, and also in order to reduce the space required, or to perform tests under extreme environmental conditions, other arrangements may be used, such as:

- anechoic chamber;
- indoor test site.

In addition, it shall be verified that the test site shall be suitable with respect to ambient noise which shall be at least 6 dB lower than the lowest specification value being measured.

The methods of measurement described in this clause are based on an open air test site. If an anechoic chamber or an indoor test site are used, some changes may apply to the method of measurement. For each radiated measurement, the nature and the dimensions of the test arrangement used shall be recorded in the test report.

##### 5.2.1.5.5.1.2 Test set up for radiated emissions of the MES

The tests shall be carried out with the MES at the specified environmental conditions and for the specified power supply voltages.

For IE, EME and IME it shall be installed with a separation of approximately 0,5 m. Between the two equipment, the maximum length connection cable specified by the applicant shall be installed. The height of the cable shall be between 0,5 m and 1 m. The cable shall be maintained in that position by non-metallic means. The EME shall be set, in its normal operating configuration on a non-conducting support at a height between 0,5 m and 1 m. The IME shall be set on a non-conducting support at a height between 0,5 m and 1 m. Any associated equipment, if required for normal operation of the MES, shall be placed next to, and at the same height as the IME.

For PE, the equipment shall be arranged in its normal operating configuration as recommended by the applicant on a non-metallic table at a height between 0,5 m and 1 m.

- b) Only the discrete signals having a level equal or greater than 6 dB below the specified limit shall be precisely measured:
- the test antenna shall be raised or lowered through the specified height range to look for the maximum signal on the spectrum analyzer (this may not be necessary if the test site is an anechoic chamber or an in-door test site);
  - the maximum measured value shall be recorded.
- c) The procedure is repeated from a) to b) with the other measurement bandwidths to cover all the frequency range to be analysed.
- d) In the case where the test site has been calibrated before, the absolute measurement is sufficient to determine the actual value of EIRP of the radiated emissions. The precise knowledge of distance between the MES and the test antenna, and the characteristics of the test antenna and the input filter allow the determination of the EIRP radiated by the MES.
- e) In the case where the test site cannot be calibrated, a relative measurement can be done according to the following procedure:

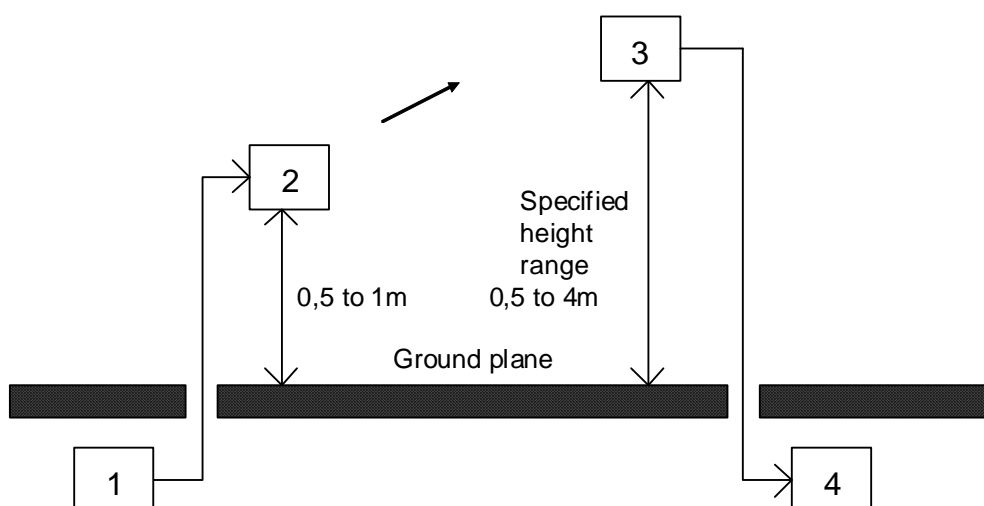

- 1) Sinusoidal RF signal generator.
- 2) Substitution antenna.
- 3) Test antenna.
- 4) Spectrum analyzer.

**Figure 3: Measurement arrangement number 2**

- using measurement arrangement number 2 of figure 3, a substitution antenna shall replace the MES in the same position where was the MES antenna. It shall be connected to the signal generator.
- f) The signal generator shall be tuned to each frequency at which an emission has been detected in the case of unwanted emissions measurement, or to the frequency at the middle of each measurement bandwidth in the case of EIRP density measurement, The substitution antenna shall be suitable for this frequency:
- the spectrum analyzer shall be tuned to the measurement bandwidth to analyse and put in the same conditions as for the measurement with the MES, with the peak hold function activated;
  - the level of the signal generator shall be adjusted to give the same signal level on the spectrum analyzer as in b);
  - the output level of the signal generator shall be recorded. This value, after corrections due to the gain of the substitution antenna and the cable loss between the signal generator and the substitution antenna, is the radiated emission level of the MES.
- g) The f) procedure is repeated with the other measurement bandwidths to cover the whole frequency range to be analysed.

The MES under test shall be placed on the support in its standard position and shall be switched-on.

Each antenna (MES antenna and test antenna) shall be positioned to be outside the near field of the other antenna.

The spectrum analyzer noise floor shall be at least 6 dB below the minimum value to be measured.

#### 5.2.1.5.5.1.3 Reference position of the MES

During radiated measurements, the MES is required to be oriented specifically in relation to the test antenna connected to the LTE. This position is called the reference position and is determined as follows:

- the MES shall be placed in a mode whereby it is transmitting;
- the MES shall be rotated in both horizontal and vertical planes in order to locate the direction of maximum field strength that is detected by the test antenna. This orientation shall be called the reference position.

#### 5.2.1.5.5.2 Measurement procedure for radiated emissions (peak)

##### 5.2.1.5.5.2.1 Measurement procedure for peak radiated emissions of the MES

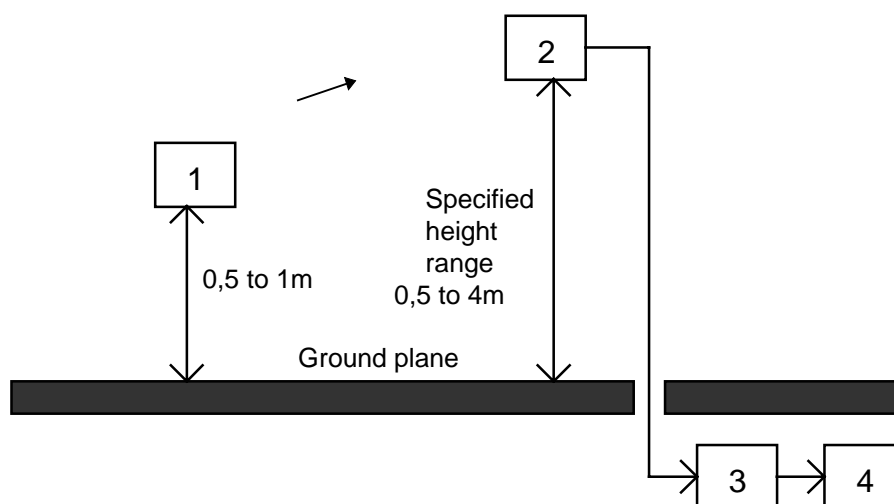

- 1) MES under test (with ~~antenna~~);
- 2) Test ~~antenna~~;
- 3) Input filter (if ~~necessary~~);
- 4) Spectrum analyzer.

**Figure 3: Measurement arrangement No. 1**

Measurement arrangement ~~No. 1~~ of figure ~~3~~ shall be used.

a) For each measurement bandwidth, the following actions shall be performed:

- the MES shall be placed in the reference position as described in ~~subclause~~ 5.2.1.5.5.1.3;
- the test antenna shall have the same polarization as the MES and connected to a spectrum analyzer, eventually through a suitable entry filter to avoid overloading of the spectrum analyzer;
- precautions may be required to ensure that the filter does not attenuate the harmonics of the carrier;
- the test antenna and the entry filter shall be suitable for the measured frequency band, and replaced by other each time it will be necessary;
- the spectrum analyzer shall be tuned to the measurement bandwidth to analyse;
- the resolution bandwidth of the spectrum analyzer shall be set to a suitable value to correctly perform the measurement, and the peak hold function shall be activated. The video bandwidth shall be set to at least 3 times the resolution bandwidth.

- h) a) to g) shall be repeated with test antennas of the opposite polarization for the unwanted emission measurements.

#### 5.2.1.5.5.2.2 Measurement procedure for peak radiated emissions of the cabinet

This method of measurement applies to transmitters having an antenna socket and has to be performed in addition to conducted measurements of the MES in the case of unwanted emissions.

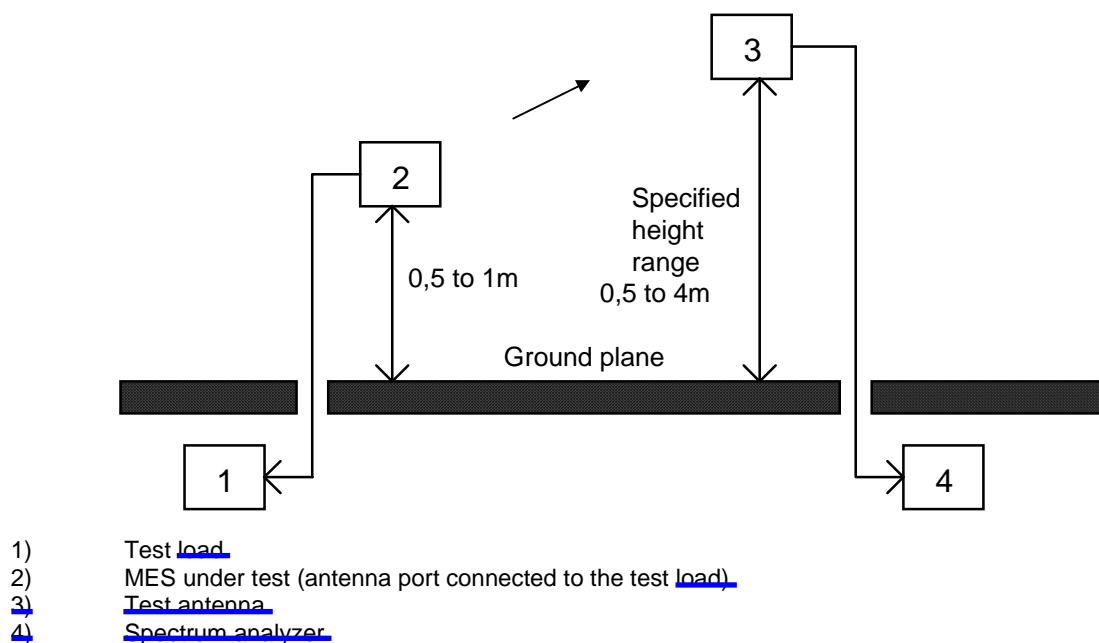

**Figure 4: Measurement arrangement number 3**

Measurement arrangement number 3 of figure 4 shall be used for measurement of radiated emissions of the cabinet.

The procedure is a peak measurement as in clause 5.2.1.5.5.2.1.

The same method as in clause 5.2.1.5.5.2.1 shall be applied with the exception that measurement arrangement number 3 replaces measurement arrangement number 1 (measurement arrangement number 2 remains the same for the relative measurement).

#### 5.2.1.5.5.3 Measurement procedure for radiated emissions (average)

##### 5.2.1.5.5.3.1 Measurement procedure for average radiated emissions of the MES

Measurement arrangement number 1 of figure 2 shall be used.

- a) For each measurement bandwidth, the following actions shall be performed:
- the MES shall be placed in the reference position as described in clause 5.2.1.5.5.1.3;
  - the test antenna shall have the same polarization as the MES and connected to a spectrum analyzer, eventually through a suitable entry filter to avoid overloading of the spectrum analyzer;
  - precautions may be required to ensure that the filter does not attenuate the harmonics of the carrier;
  - the test antenna and the entry filter shall be suitable for the measured frequency band, and replaced by other each time it will be necessary;
  - the spectrum analyzer shall be tuned to the measurement bandwidth to analyse;
  - the resolution bandwidth of the spectrum analyzer shall be set to a suitable value to correctly perform the measurement, and the average function shall be activated. The video bandwidth shall be set to the same value as the resolution bandwidth.



- b) Only the discrete signals having a level equal or greater than 6 dB below the specified limit shall be precisely measured:
- the test antenna shall be raised or lowered through the specified height range to look for the maximum signal on the spectrum analyzer (this may not be necessary if the test site is an anechoic chamber or an in-door test site);
  - the maximum measured value shall be recorded.
- c) The procedure is repeated from a) to b) with the other measurement bandwidths to cover all the frequency range to be analysed.
- d) In the case where the test site has been calibrated before, the absolute measurement is sufficient to determine the actual value of EIRP of the radiated emissions. The precise knowledge of distance between the MES and the test antenna, and the characteristics of the test antenna and the input filter allow the determination of the EIRP radiated by the MES.
- e) In the case where the test site cannot be calibrated, a relative measurement can be done according to the following procedure:

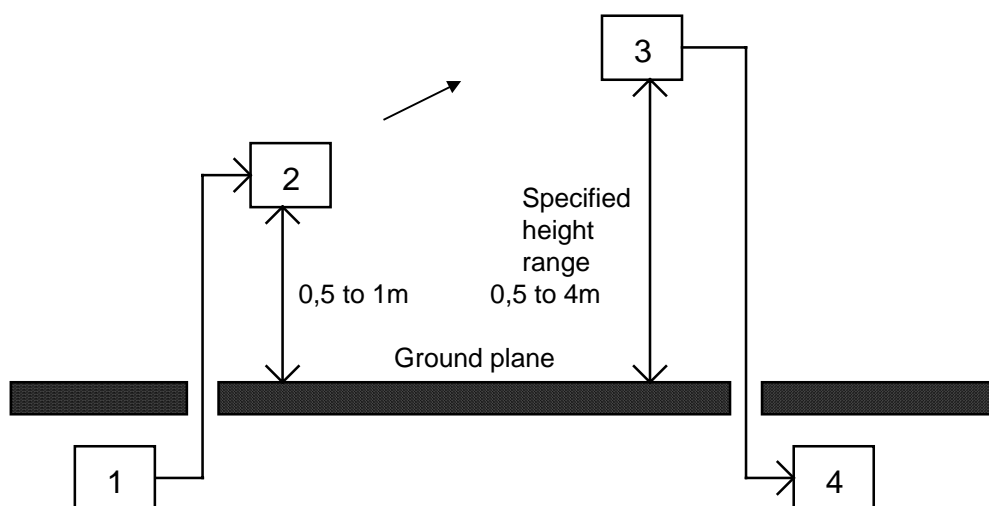

- 1) Sinusoidal RF signal generator;
- 2) Substitution antenna;
- 3) Test antenna;
- 4) Spectrum analyzer.

**Figure 4: Measurement arrangement No. 2**

- using measurement arrangement ~~No. 2~~ of figure 4, a substitution antenna shall replace the MES in the same position where was the MES antenna. It shall be connected to the signal generator.
- f) The signal generator shall be tuned to each frequency at which an emission has been detected in the case of unwanted emissions measurement, or to the frequency at the middle of each measurement bandwidth in the case of EIRP density measurement, The substitution antenna shall be suitable for this frequency:
- the spectrum analyzer shall be tuned to the measurement bandwidth to analyse and put in the same conditions as for the measurement with the MES, with the peak hold function activated;
  - the level of the signal generator shall be adjusted to give the same signal level on the spectrum analyzer as in b);
  - the output level of the signal generator shall be recorded. This value, after corrections due to the gain of the substitution antenna and the cable loss between the signal generator and the substitution antenna, is the radiated emission level of the MES.
- g) The f) procedure is repeated with the other measurement bandwidths to cover the whole frequency range to be analysed.
- h) a) to g) shall be repeated with test antennas of the opposite polarization for the unwanted emission measurements.

- b) The test antenna shall be raised or lowered through the specified height range to look for the maximum received signal on the spectrum analyzer (this step may not be necessary if the test site is an anechoic chamber or an indoor test site):
- the EIRP shall be averaged until the variance over the measured bandwidth is less than 1 dB. The averaged value shall be recorded.
- c) The procedure shall be repeated from a) to b) with the other measurement bandwidths to cover the whole frequency range to be analysed.
- d) In the case where the test site has been calibrated before, the absolute measurement is sufficient to determine the actual value of EIRP of the radiated emissions. The precise knowledge of distance between the MES and the test antenna, the characteristics of the test antenna and the input filter allow the determination of the EIRP radiated by the MES.
- e) In the case where the test site cannot be calibrated, a relative measurement can be done according to the following procedure:
- using measurement arrangement [number 2](#) of figure [3](#), a substitution antenna shall replace the MES in the same position where was the MES antenna. It shall be connected to the signal generator.
- f) The signal generator shall be tuned to the centre frequency of each measurement bandwidth. The substitution antenna shall be suitable for this frequency:
- the spectrum analyzer shall be tuned to the measurement bandwidth to analyse and put in the same conditions as for the measurement with the MES with the average function activated;
  - the level of the signal generator shall be adjusted to give the same signal level on the spectrum analyzer as in b) when averaged until the variance over the measured bandwidth is less than 1 dB. The output level of the signal generator shall be recorded;
  - this value, after corrections due to the gain of the substitution antenna and the cable loss between the signal generator and the substitution antenna, is the radiated emission level of the MES.
- g) The f) procedure shall be repeated with the other measurement bandwidths to cover the whole frequency range to be analysed.
- h) a) to g) shall be repeated with test antennas of the opposite polarization for the unwanted emission measurements.

#### 5.2.1.5.5.3.2 Measurement procedure for average radiated emissions of the cabinet

This method of measurement applies to transmitters having an antenna socket and has to be performed in addition to conducted measurements of the MES for unwanted emissions.

Measurement arrangement [number 3](#) of figure [4](#) shall be used for measurement of radiated emissions of the cabinet.

The procedure is an average measurement as in [clause 5.2.1.5.5.3.1](#).

The same method as in [clause 5.2.1.5.5.3.1](#) shall be applied with the exception that measurement arrangement [number 3](#) replaces measurement arrangement [number 1](#) (measurement arrangement [number 2](#) remains the same for the relative measurement).

#### 5.2.1.5.6 Procedures for measurement of MES RF conducted emissions

##### 5.2.1.5.6.1 General

[Clause 5.2.1.5.6](#) contains the procedure for conducted emission measurements.

It is recognized that for some parameters, alternative test methods may exist. It is the responsibility of the test laboratory to ensure that any alternative test method used yields results identical to those described in the present document.

### 5.2.1.5.5.2.2 Measurement procedure for peak radiated emissions of the cabinet

This method of measurement applies to transmitters having an antenna socket and has to be performed in addition to conducted measurements of the MES in the case of unwanted emissions.

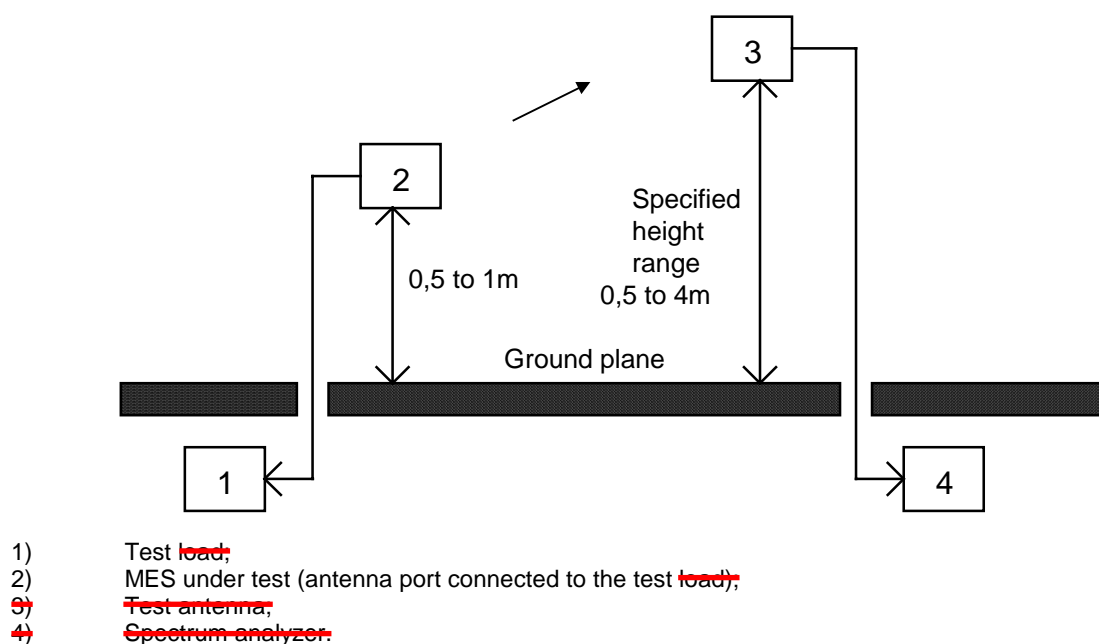

- 1) Test load;
- 2) MES under test (antenna port connected to the test load);
- 3) Test antenna;
- 4) Spectrum analyzer.

**Figure 5. Measurement arrangement No. 3**

~~Measurement arrangement No. 3 of figure 5 shall be used for measurement of radiated emissions of the cabinet.~~

The procedure is a peak measurement as in ~~subclause 5.2.1.5.5.2.1.~~

The same method as in ~~subclause 5.2.1.5.5.2.1~~ shall be applied with the exception that measurement arrangement ~~No. 3~~ replaces measurement arrangement ~~No. 1~~ (measurement arrangement ~~No. 2~~ remains the same for the relative measurement).

### 5.2.1.5.5.3 Measurement procedure for radiated emissions (average)

#### 5.2.1.5.5.3.1 Measurement procedure for average radiated emissions of the MES

Measurement arrangement ~~No. 1~~ of figure ~~3~~ shall be used.

- a) For each measurement bandwidth, the following actions shall be performed:
  - the MES shall be placed in the reference position as described in ~~subclause 5.2.1.5.5.1.3~~;
  - the test antenna shall have the same polarization as the MES and connected to a spectrum analyzer, eventually through a suitable entry filter to avoid overloading of the spectrum analyzer;
  - precautions may be required to ensure that the filter does not attenuate the harmonics of the carrier;
  - the test antenna and the entry filter shall be suitable for the measured frequency band, and replaced by other each time it will be necessary;
  - the spectrum analyzer shall be tuned to the measurement bandwidth to analyse;
  - the resolution bandwidth of the spectrum analyzer shall be set to a suitable value to correctly perform the measurement, and the average function shall be activated. The video bandwidth shall be set to the same value as the resolution bandwidth.

#### 5.2.1.5.6.1.1 Test site

There are no specific requirements for the test site for conducted measurements except that they shall be performed in such a way as to ensure that there is no interference to operational satellite and terrestrial systems.

#### 5.2.1.5.6.1.2 Test set-up

Measurement arrangement of figure 5 shall be used.

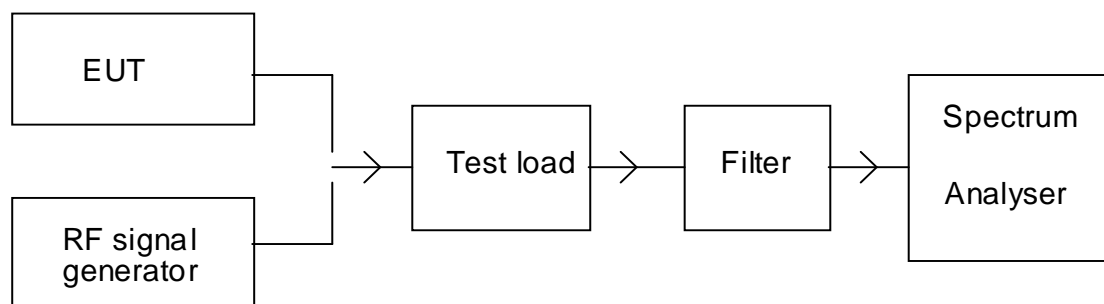

**Figure 5: Measurement arrangement for conducted emissions**

The antenna port of the MES shall be connected to a spectrum analyzer through a test load and eventually an appropriate filter to avoid overloading of the spectrum analyzer.

Precautions may be required to ensure that the test load does not generate or that the filter does not attenuate, the harmonics of the carrier. The entry filter shall be suitable for the measured frequency band, and replaced by another each time it will be necessary.

The spectrum analyzer noise floor shall be at least 6 dB below the minimum value to be measured.

#### 5.2.1.5.6.2 Measurement procedure for conducted emissions (peak)

- a) For each measurement bandwidth, the following actions shall be performed:
  - the spectrum analyzer shall be tuned to the measurement bandwidth to analyse;
  - the resolution bandwidth of the spectrum analyzer shall be set to a suitable value to correctly perform the measurement, and the peak hold function shall be activated. The video bandwidth shall be set to at least 3 times the resolution bandwidth.
- b) The peak power detected value of each discrete signal having a level equal or greater than 6 dB below the specified limit shall be recorded.
- c) The procedure shall be repeated from a) to b) with the other measurement bandwidths to cover all the spectrum band which is required to be measured.
- d) The actual value of EIRP of the equivalent radiated emissions in each measurement bandwidth shall be derived by adding either the MES maximum antenna gain or the declared gain at the spurious emission frequency to the power value read from the spectrum analyzer.

#### 5.2.1.5.6.3 Measurement procedure for conducted emissions (average)

- a) For each measurement bandwidth, the following actions shall be performed:
  - the resolution bandwidth of the spectrum analyzer shall be set to a suitable value to correctly perform the measurement, and the average function shall be activated. The video bandwidth shall be set to the same value as the resolution bandwidth;
  - the measurement time should be such that the difference of the measured levels, averaged over subsequent measurement samples, is less than 1 dB, or a measurement time of 100 ms may be used if the measured values comply with the applicable limits.
- b) The averaged power density value within the measured bandwidth shall be recorded.

- b) The test antenna shall be raised or lowered through the specified height range to look for the maximum received signal on the spectrum analyzer (this step may not be necessary if the test site is an anechoic chamber or an indoor test site):
- the EIRP shall be averaged until the variance over the measured bandwidth is less than 1 dB. The averaged value shall be recorded.
- c) The procedure shall be repeated from a) to b) with the other measurement bandwidths to cover the whole frequency range to be analysed.
- d) In the case where the test site has been calibrated before, the absolute measurement is sufficient to determine the actual value of EIRP of the radiated emissions. The precise knowledge of distance between the MES and the test antenna, the characteristics of the test antenna and the input filter allow the determination of the EIRP radiated by the MES.
- e) In the case where the test site cannot be calibrated, a relative measurement can be done according to the following procedure:
- using measurement arrangement ~~No. 2~~ of figure ~~4~~, a substitution antenna shall replace the MES in the same position where was the MES antenna. It shall be connected to the signal generator.
- f) The signal generator shall be tuned to the centre frequency of each measurement bandwidth. The substitution antenna shall be suitable for this frequency:
- the spectrum analyzer shall be tuned to the measurement bandwidth to analyse and put in the same conditions as for the measurement with the MES with the average function activated;
  - the level of the signal generator shall be adjusted to give the same signal level on the spectrum analyzer as in b) when averaged until the variance over the measured bandwidth is less than 1 dB. The output level of the signal generator shall be recorded;
  - this value, after corrections due to the gain of the substitution antenna and the cable loss between the signal generator and the substitution antenna, is the radiated emission level of the MES.
- g) The f) procedure shall be repeated with the other measurement bandwidths to cover the whole frequency range to be analysed.
- h) a) to g) shall be repeated with test antennas of the opposite polarization for the unwanted emission measurements.

#### 5.2.1.5.5.3.2 Measurement procedure for average radiated emissions of the cabinet

This method of measurement applies to transmitters having an antenna socket and has to be performed in addition to conducted measurements of the MES for unwanted emissions.

Measurement arrangement ~~No. 3~~ of figure ~~5~~ shall be used for measurement of radiated emissions of the cabinet.

The procedure is an average measurement as in ~~subclause~~ 5.2.1.5.5.3.1.

The same method as in ~~subclause~~ 5.2.1.5.5.3.1 shall be applied with the exception that measurement arrangement ~~No. 3~~ replaces measurement arrangement ~~No. 1~~ (measurement arrangement ~~No. 2~~ remains the same for the relative measurement).

#### 5.2.1.5.6 Procedures for measurement of MES RF conducted emissions

##### 5.2.1.5.6.1 General

~~Subclause~~ 5.2.1.5.6 contains the procedure for conducted emission measurements.

It is recognized that for some parameters, alternative test methods may exist. It is the responsibility of the test laboratory to ensure that any alternative test method used yields results identical to those described in the present document.

- c) The procedure shall be repeated from a) to b) with the other measurement bandwidths to cover the whole frequency range to be analysed.
- d) The actual value of EIRP of the radiated emissions in each measurement bandwidth shall be derived by adding the MES maximum antenna gain measured at the normal operating frequency to the power spectral density value read from the spectrum analyzer.

#### 5.2.1.5.7 Interpretation of the measurement results

The interpretation of the results for the measurements described in the present document shall be as follows:

- a) the measured value related to the corresponding limit shall be used to decide whether an equipment meets the minimum requirements of the standard;
- b) the actual measurement uncertainty of the test laboratory carrying out the measurement, for each particular measurement, shall be included in the test report;
- c) the values of the actual measurement uncertainty shall be, for each measurement, equal to or lower than the figures in [clause 5.2.1.5.3](#).

#### 5.2.1.5.8 Test report

All results of the tests performed shall be recorded in a test report.

For each test, the test report shall also include the test conditions (status of the MES, frequency of operation), the measurement uncertainties and the environmental test conditions.

### 5.2.2 Unwanted emissions outside the band 1 980,1 MHz to 2 009,9 MHz (carrier-on)

#### 5.2.2.1 Method of test

This test shall be carried out for the minimum and for the maximum MES transmit frequencies for which the MES is designed to operate, as specified by the applicant.

The environmental test conditions are given in [clause 5.1](#).

For each test, the MES shall be set to transmit (carrier-on) on one of the specified transmitting frequencies to be tested at its maximum power for that transmit frequency, by means of the STE or by another test facility provided by the applicant.

If there is a handover function in the MES (to allow change of frequency channel during a call), this function shall be disabled.

The transmitted carrier shall be modulated by a test signal at maximum rate as specified in [clause 5.2.1.5.2.2](#).

In the test equipment, the spectrum analyzer noise floor shall be at least 6 dB below the appropriate limits given in table 3.

The measurements are performed with the radiated or with the conducted method according to the cases defined in [clause 5.2.1.5.4](#).

For measurements of radiated unwanted emissions, [clause 5.2.1.5.5](#) applies.

For measurements of conducted unwanted emissions, [clause 5.2.1.5.6](#) applies.

#### 5.2.2.2 Peak measurement

In the case of peak measurement, the spectrum analyzer shall be set in sweep mode and shall be operated under the following conditions:

frequency sweep: as required for frequency range to be assessed;

#### 5.2.1.5.6.1.1 Test site

There are no specific requirements for the test site for conducted measurements except that they shall be performed in such a way as to ensure that there is no interference to operational satellite and terrestrial systems.

#### 5.2.1.5.6.1.2 Test set-up

Measurement arrangement of figure 6 shall be used.

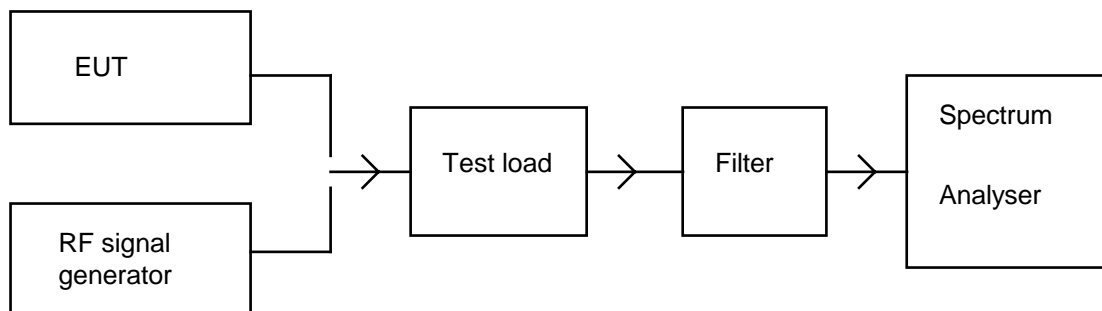

**Figure 6: Measurement arrangement for conducted emissions**

The antenna port of the MES shall be connected to a spectrum analyzer through a test load and eventually an appropriate filter to avoid overloading of the spectrum analyzer.

Precautions may be required to ensure that the test load does not generate or that the filter does not attenuate, the harmonics of the carrier. The entry filter shall be suitable for the measured frequency band, and replaced by another each time it will be necessary.

The spectrum analyzer noise floor shall be at least 6 dB below the minimum value to be measured.

#### 5.2.1.5.6.2 Measurement procedure for conducted emissions (peak)

- a) For each measurement bandwidth, the following actions shall be performed:
  - the spectrum analyzer shall be tuned to the measurement bandwidth to analyse;
  - the resolution bandwidth of the spectrum analyzer shall be set to a suitable value to correctly perform the measurement, and the peak hold function shall be activated. The video bandwidth shall be set to at least 3 times the resolution bandwidth.
- b) The peak power detected value of each discrete signal having a level equal or greater than 6 dB below the specified limit shall be recorded.
- c) The procedure shall be repeated from a) to b) with the other measurement bandwidths to cover all the spectrum band which is required to be measured.
- d) The actual value of EIRP of the equivalent radiated emissions in each measurement bandwidth shall be derived by adding either the MES maximum antenna gain or the declared gain at the spurious emission frequency to the power value read from the spectrum analyzer.

#### 5.2.1.5.6.3 Measurement procedure for conducted emissions (average)

- a) For each measurement bandwidth, the following actions shall be performed:
  - the resolution bandwidth of the spectrum analyzer shall be set to a suitable value to correctly perform the measurement, and the average function shall be activated. The video bandwidth shall be set to the same value as the resolution bandwidth;
  - the measurement time should be such that the difference of the measured levels, averaged over subsequent measurement samples, is less than 1 dB, or a measurement time of 100 ms may be used if the measured values comply with the applicable limits.

resolution bandwidth:	measurement bandwidth specified in table 3;
display bandwidth:	at least three times the measurement bandwidth;
averaging:	no;
peak hold:	yes.

The sweep time shall be the shortest possible time consistent with proper calibration and ease of operation.

The spectrum analyzer shall be stepped over the frequency ranges specified in table 3 for peak measurement.

### 5.2.2.3 Average measurement

In the case of average measurement, the spectrum analyzer shall be set in sweep mode and shall be operated under the following conditions:

frequency sweep:	as required for frequency range to be assessed;
resolution bandwidth:	measurement bandwidth specified in table 3;
display bandwidth:	equal to the measurement bandwidth;
averaging:	yes;
peak hold:	no.

The measurement time shall be such that the difference of the measured levels, averaged over subsequent measurement samples, is less than 1 dB, or a measurement time of 100 ms may be used if the measured values comply with the applicable limits.

For a MES operating in a non-continuous carrier mode, the measurement shall be performed over the active part of the transmitted bursts. The total sample time used for measurement shall be not less than 40 % of the duration of the active part of the transmitted burst. The measurement shall be made over the random part of the burst, excluding any preambles or synchronization sequences.

The spectrum analyzer shall be stepped over the frequency ranges specified in table 3 for average measurement.

### 5.2.2.4 Test requirements

For measurements of radiated unwanted emissions of the MES, the measured values shall in no case exceed the limits given in table 3.

For measurements of conducted unwanted emissions of the MES, the measured values plus the maximum antenna gain shall in no case exceed the limits given in table 3.

## 5.2.3 Unwanted emissions within the bands 1 980,1 MHz to 2 009,9 MHz, 1 978,1 MHz to 1 980,1 MHz and 2 009,9 MHz to 2 011,9 MHz (carrier-on)

### 5.2.3.1 Method of test

This test shall be carried out for the minimum and for the maximum MES transmit frequency for which the MES is designed to operate, as specified by the applicant.

The transmit frequencies used for the test shall be entered in the test report.

The environmental test conditions are given in [clause 5.1](#).

For each test, the MES shall be set to transmit (carrier-on) on one of the specified transmit frequencies to be tested, at its maximum power for that transmit frequency, by means of the STE or by another test facility provided by the applicant.



- b) The averaged power density value within the measured bandwidth shall be recorded.
- c) The procedure shall be repeated from a) to b) with the other measurement bandwidths to cover the whole frequency range to be analysed.
- d) The actual value of EIRP of the radiated emissions in each measurement bandwidth shall be derived by adding the MES maximum antenna gain measured at the normal operating frequency to the power spectral density value read from the spectrum analyzer.

#### 5.2.1.5.7 Interpretation of the measurement results

The interpretation of the results for the measurements described in the present document shall be as follows:

- a) the measured value related to the corresponding limit shall be used to decide whether an equipment meets the minimum requirements of the standard;
- b) the actual measurement uncertainty of the test laboratory carrying out the measurement, for each particular measurement, shall be included in the test report;
- c) the values of the actual measurement uncertainty shall be, for each measurement, equal to or lower than the figures in ~~subclause~~ 5.2.1.5.3.

#### 5.2.1.5.8 Test report

All results of the tests performed shall be recorded in a test report.

For each test, the test report shall also include the test conditions (status of the MES, frequency of operation), the measurement uncertainties and the environmental test conditions.

### 5.2.2 Unwanted emissions outside the band 1 980,1 MHz to 2 009,9 MHz (carrier-on)

#### 5.2.2.1 Method of test

This test shall be carried out for the minimum and for the maximum MES transmit frequencies for which the MES is designed to operate, as specified by the applicant.

The environmental test conditions are given in ~~subclause~~ 5.1.

For each test, the MES shall be set to transmit (carrier-on) on one of the specified transmitting frequencies to be tested at its maximum power for that transmit frequency, by means of the STE or by another test facility provided by the applicant.

If there is a handover function in the MES (to allow change of frequency channel during a call), this function shall be disabled.

The transmitted carrier shall be modulated by a test signal at maximum rate as specified in ~~subclause~~ 5.2.1.5.2.2.

In the test equipment, the spectrum analyzer noise floor shall be at least 6 dB below the appropriate limits given in table 3.

The measurements are performed with the radiated or with the conducted method according to the cases defined in ~~subclause~~ 5.2.1.5.4.

For measurements of radiated unwanted emissions, ~~subclause~~ 5.2.1.5.5 applies.

For measurements of conducted unwanted emissions, ~~subclause~~ 5.2.1.5.6 applies.

If there is a handover function in the MES (to allow change of frequency channel during a call), this function shall be disabled.

The transmitted carrier shall be modulated by a test signal at maximum rate as specified in [clause 5.2.1.5.2.2](#).

In the test equipment, the spectrum analyzer noise floor shall be at least 6 dB below the appropriate limits given in tables 4 or 5, as applicable.

The measurements are performed with the radiated or with the conducted method according to the cases defined in [clause 5.2.1.5.4](#).

For measurements of radiated unwanted emissions, [clause 5.2.1.5.5](#) applies.

For measurements of conducted unwanted emissions, [clause 5.2.1.5.6](#) applies.

### 5.2.3.2 Measurement method

The spectrum analyzer shall be set in sweep mode and shall be operated under the following conditions:

frequency sweep:	as required for frequency range to be assessed;
resolution bandwidth:	measurement bandwidth specified in tables 4 or 5, as applicable;
display bandwidth:	equal to the measurement bandwidth;
averaging:	yes;
peak hold:	no.

The measurement time should be such that the difference of the measured levels, averaged over subsequent measurement samples, is less than 1 dB, or a measurement time of 100 ms may be used if the measured values comply with the applicable limits.

For a MES operating in a non-continuous carrier mode, the measurement shall be performed over the active part of the transmitted bursts. The total sample time used for measurement shall be not less than 40 % of the duration of the active part of the transmitted burst. The measurement shall be made over the random part of the burst, excluding any preambles or synchronization sequences.

For each of the transmit frequencies to be used for the test, measurements shall be made over the frequency ranges from 1 978,1 MHz to  $f_c - a$  and from  $f_c + b$  to 2 011,9 MHz,  $f_c - a$  being the lower boundary frequency of the nominated bandwidth for the transmit frequency being tested, and  $f_c + b$  being the upper boundary frequency of the nominated bandwidth for the transmit frequency being tested.

### 5.2.3.3 Test requirements

For measurements of radiated unwanted emissions of the MES, the measured values shall in no case exceed the limits given in tables 4 or 5, as applicable, over the frequency range 1 978,1 MHz to 2 011,9 MHz.

For measurements of conducted unwanted emissions, the measured values plus the maximum antenna gain, shall in no case exceed the limits given in tables 4 or 5, as applicable, over the frequency range 1 978,1 MHz to 2 011,9 MHz.

## 5.2.4 Unwanted emissions in carrier-off state

### 5.2.4.1 Method of test

The MES shall be switched-on and set in a non-transmitting (carrier-off) mode.

If there is a periodic automatic transmission of bursts (e.g. for location updating), the STE shall provide a means to inhibit it, or to trigger the measurement in order to analyse only the non-transmitting periods.

The environmental test conditions are given in [clause 5.1](#).

### 5.2.2.2 Peak measurement

In the case of peak measurement, the spectrum analyzer shall be set in sweep mode and shall be operated under the following conditions:

frequency sweep:	as required for frequency range to be assessed;
resolution bandwidth:	measurement bandwidth specified in table 3;
display bandwidth:	at least three times the measurement bandwidth;
averaging:	no;
peak hold:	yes.

The sweep time shall be the shortest possible time consistent with proper calibration and ease of operation.

The spectrum analyzer shall be stepped over the frequency ranges specified in table 3 for peak measurement.

### 5.2.2.3 Average measurement

In the case of average measurement, the spectrum analyzer shall be set in sweep mode and shall be operated under the following conditions:

frequency sweep:	as required for frequency range to be assessed;
resolution bandwidth:	measurement bandwidth specified in table 3;
display bandwidth:	equal to the measurement bandwidth;
averaging:	yes;
peak hold:	no.

The measurement time shall be such that the difference of the measured levels, averaged over subsequent measurement samples, is less than 1 dB, or a measurement time of 100 ms may be used if the measured values comply with the applicable limits.

For a MES operating in a non-continuous carrier mode, the measurement shall be performed over the active part of the transmitted bursts. The total sample time used for measurement shall be not less than 40 % of the duration of the active part of the transmitted burst. The measurement shall be made over the random part of the burst, excluding any preambles or synchronization sequences.

The spectrum analyzer shall be stepped over the frequency ranges specified in table 3 for average measurement.

### 5.2.2.4 Test requirements

For measurements of radiated unwanted emissions of the MES, the measured values shall in no case exceed the limits given in table 3.

For measurements of conducted unwanted emissions of the MES, the measured values plus the maximum antenna gain shall in no case exceed the limits given in table 3.

## 5.2.3 Unwanted emissions within the bands 1 980,1 MHz to 2 009,9 MHz, 1 978,1 MHz to 1 980,1 MHz and 2 009,9 MHz to 2 011,9 MHz (carrier-on)

### 5.2.3.1 Method of test

This test shall be carried out for the minimum and for the maximum MES transmit frequency for which the MES is designed to operate, as specified by the applicant.

In the test equipment, the spectrum analyzer noise floor shall be at least 6 dB below the appropriate limits given in table 6.

The measurements are performed with the radiated or with the conducted method according to the cases defined in [clause 5.2.1.5.4](#).

For measurements of radiated unwanted emissions, [clause 5.2.1.5.5](#) applies.

For measurements of conducted unwanted emissions, [clause 5.2.1.5.6](#) applies.

#### 5.2.4.2 Measurement method

The spectrum analyzer shall be set in sweep mode and shall be operated under the following conditions:

frequency sweep:	as required for frequency range to be assessed;
resolution bandwidth:	measurement bandwidth specified in table 6;
display bandwidth:	at least 3 times the measurement bandwidth;
averaging:	no;
peak hold:	yes.

The sweep time shall be the shortest possible time consistent with proper calibration and ease of operation.

The spectrum analyzer shall be stepped over the frequency ranges specified.

#### 5.2.4.3 Test requirements

For measurements of radiated unwanted emissions of the MES, the measured values shall in no case exceed the limits given in table 6.

For measurements of conducted unwanted emissions of the MES, the measured values plus the maximum antenna gain shall in no case exceed the limits given in table 6.

### 5.2.5 MES Control and Monitoring Functions (CMF)

#### 5.2.5.1 Self-monitoring functions / Processor Monitoring

As it is considered impracticable to artificially induce processor faults in an MES, no test is given for the processor monitoring function.

#### 5.2.5.2 Self-monitoring functions / Transmit frequency generation sub-system monitoring

As it is considered impracticable to artificially induce transmit frequency generation sub-system faults in an MES, no test is given for the transmit frequency generation sub-system monitoring function.

#### 5.2.5.3 Network control authorization

##### 5.2.5.3.1 Method of test

The MES shall be cycled through its power-on and power-off states. Attempts shall be made to initiate calls using normal user operational procedures. The transmitting state of the MES shall be monitored to ensure compliance with the test requirements.

[The environmental test conditions are given in clause 5.1](#)

The transmit frequencies used for the test shall be entered in the test report.

The environmental test conditions are given in ~~subclause~~ 5.1.

For each test, the MES shall be set to transmit (carrier-on) on one of the specified transmit frequencies to be tested, at its maximum power for that transmit frequency, by means of the STE or by another test facility provided by the applicant.

If there is a handover function in the MES (to allow change of frequency channel during a call), this function shall be disabled.

The transmitted carrier shall be modulated by a test signal at maximum rate as specified in ~~subclause~~ 5.2.1.5.2.2.

In the test equipment, the spectrum analyzer noise floor shall be at least 6 dB below the appropriate limits given in tables 4 or 5, as applicable.

The measurements are performed with the radiated or with the conducted method according to the cases defined in ~~subclause~~ 5.2.1.5.4.

For measurements of radiated unwanted emissions, ~~subclause~~ 5.2.1.5.5 applies.

For measurements of conducted unwanted emissions, ~~subclause~~ 5.2.1.5.6 applies.

### 5.2.3.2 Measurement method

The spectrum analyzer shall be set in sweep mode and shall be operated under the following conditions:

frequency sweep:	as required for frequency range to be assessed;
resolution bandwidth:	measurement bandwidth specified in tables 4 or 5, as applicable;
display bandwidth:	equal to the measurement bandwidth;
averaging:	yes;
peak hold:	no.

The measurement time should be such that the difference of the measured levels, averaged over subsequent measurement samples, is less than 1 dB, or a measurement time of 100 ms may be used if the measured values comply with the applicable limits.

For a MES operating in a non-continuous carrier mode, the measurement shall be performed over the active part of the transmitted bursts. The total sample time used for measurement shall be not less than 40 % of the duration of the active part of the transmitted burst. The measurement shall be made over the random part of the burst, excluding any preambles or synchronization sequences.

For each of the transmit frequencies to be used for the test, measurements shall be made over the frequency ranges from 1 978,1 MHz to  $f_c - a$  and from  $f_c + b$  to 2 011,9 MHz,  $f_c - a$  being the lower boundary frequency of the nominated bandwidth for the transmit frequency being tested, and  $f_c + b$  being the upper boundary frequency of the nominated bandwidth for the transmit frequency being tested.

### 5.2.3.3 Test requirements

For measurements of radiated unwanted emissions of the MES, the measured values shall in no case exceed the limits given in tables 4 or 5, as applicable, over the frequency range 1 978,1 MHz to 2 011,9 MHz.

For measurements of conducted unwanted emissions, the measured values plus the maximum antenna gain, shall in no case exceed the limits given in tables 4 or 5, as applicable, over the frequency range 1 978,1 MHz to 2 011,9 MHz.

## 5.2.4 Unwanted emissions in carrier-off state

### 5.2.4.1 Method of test

The MES shall be switched-on and set in a non-transmitting (carrier-off) mode.

### 5.2.5.3.2 Test procedure

The MES shall be situated in an environment where receipt of the appropriate network control channel(s) is controlled by the test laboratory:

- a) The MES shall be in a power-off state, situated such that it is not in receipt of a network control channel.
- b) The MES shall be powered-on.
- c) An attempt shall be made, using normal user operational procedures, to initiate a call.
- d) A network control channel shall be activated and a call shall be initiated using normal user operational procedures.
- e) The network control channel shall then be deactivated.
- f) An attempt shall be made, using normal user operational procedures, to initiate a call.
- g) The network control channel shall be reactivated and a call shall be initiated using normal user operational procedures.

Throughout this procedure, the transmission state of the MES shall be monitored.

### 5.2.5.3.3 Test requirement

During and after test procedure step a), the MES shall be in power-off state.

During and after test procedure step b), no transmissions shall occur (carrier-off).

During and after test procedure step c), no transmissions shall occur (carrier-off).

After test procedure step d), the MES shall be transmitting (carrier-on).

Within 30 seconds of test procedure step e), MES transmissions shall cease (carrier-off).

During and after test procedure step f), no transmissions shall occur (carrier-off).

After test procedure step g), the MES shall be transmitting (carrier-on).

## 5.2.5.4 Network control reception

### 5.2.5.4.1 Transmit frequency control

#### 5.2.5.4.1.1 Method of test

The nominated bandwidth of the MES shall be monitored relative to the carrier frequency commanded, and relative to the operational frequency bands for the MES specified by the applicant.

The environmental test conditions are given in clause 5.1.

#### 5.2.5.4.1.2 Test procedure

This test shall be carried out at least twice, once for the minimum and once for the maximum MES transmit frequency for which the MES is designed to operate, as specified by the applicant.

Where available, two additional transmit frequencies shall also be tested. These frequencies shall be equally spaced between the minimum and maximum frequencies. The commanded transmit frequencies used for the test shall be entered in the test report.

The MES shall be situated in an environment where receipt of a network control channel and of NCF commands is controlled by the test laboratory:

- a) A network control channel shall be activated and the MES powered-on.

If there is a periodic automatic transmission of bursts (e.g. for location updating), the STE shall provide a means to inhibit it, or to trigger the measurement in order to analyse only the non-transmitting periods.

The environmental test conditions are given in ~~subclause 5.1~~.

In the test equipment, the spectrum analyzer noise floor shall be at least 6 dB below the appropriate limits given in table 6.

The measurements are performed with the radiated or with the conducted method according to the cases defined in ~~subclause 5.2.1.5.4~~.

For measurements of radiated unwanted emissions, ~~subclause 5.2.1.5.5~~ applies.

For measurements of conducted unwanted emissions, ~~subclause 5.2.1.5.6~~ applies.

#### 5.2.4.2 Measurement method

The spectrum analyzer shall be set in sweep mode and shall be operated under the following conditions:

frequency sweep:	as required for frequency range to be assessed;
resolution bandwidth:	measurement bandwidth specified in table 6;
display bandwidth:	at least 3 times the measurement bandwidth;
averaging:	no;
peak hold:	yes.

The sweep time shall be the shortest possible time consistent with proper calibration and ease of operation.

The spectrum analyzer shall be stepped over the frequency ranges specified.

#### 5.2.4.3 Test requirements

For measurements of radiated unwanted emissions of the MES, the measured values shall in no case exceed the limits given in table 6.

For measurements of conducted unwanted emissions of the MES, the measured values plus the maximum antenna gain shall in no case exceed the limits given in table 6.

### 5.2.5 MES Control and Monitoring Functions (CMF)

#### 5.2.5.1 Self-monitoring functions / Processor Monitoring

As it is considered impracticable to artificially induce processor faults in an MES, no test is given for the processor monitoring function.

#### 5.2.5.2 Self-monitoring functions / Transmit frequency generation sub-system monitoring

As it is considered impracticable to artificially induce transmit frequency generation sub-system faults in an MES, no test is given for the transmit frequency generation sub-system monitoring function.

#### 5.2.5.3 Network control authorization

##### 5.2.5.3.1 Method of test

The MES shall be cycled through its power-on and power-off states. Attempts shall be made to initiate calls using normal user operational procedures. The transmitting state of the MES shall be monitored to ensure compliance with the test requirements.

- b) An appropriate NCF control message shall be sent, commanding the MES to set its carrier frequency to one of the transmit frequencies to be tested.
- c) The test shall be repeated for the other transmit frequencies to be tested.

The carrier mask for the transmit frequency under test shall be monitored on a spectrum analyzer, using the procedures given in [clause 5.2.3.1](#).

#### 5.2.5.4.1.3 Test requirement

The MES shall set the centre frequency of its transmission according to the NCF command.

The entire nominated bandwidth for each transmit frequency tested shall be contained completely within the operational frequency band(s) specified by the applicant.

### 5.2.5.5 Fellow radio stations in a dual-mode or multi-mode terminal

#### 5.2.5.5.1 Method of test

The MES shall be placed in a suitable environment which isolates the MES from the networks of its fellow modes. It shall be verified that no transmissions are made from that mode.

#### 5.2.5.5.2 Test procedure

The MES shall be placed in an environment where the receipt of network control channel(s) of supporting networks of the fellow modes is prevented. For each fellow mode radio station, an attempt shall be made, using normal user operational procedures, to initiate a call. Throughout this procedure, the transmission state of the MES shall be monitored.

#### 5.2.5.5.3 Test requirements

Throughout the test procedure, no transmission shall occur.

## 5.2.6 Equipment identity

### 5.2.6.1 Method of test

It is impracticable to test that each MES has a unique MES Identification Code (MIC) within its S-PCN, and that it is not possible for the user to alter the MIC using any normally accessible procedure. Consequently, no tests are given for these requirements.

The transmissions of the MES in response to an NCF command to send its identification code shall be monitored and the identification code received shall be verified.

The environmental test conditions are given in [clause 5.1](#).

### 5.2.6.2 Test procedure

The MES shall be situated in an environment where receipt of a network control channel and of NCF commands is controlled by the test [laboratory](#):

- a) A network control channel shall be activated and the MES powered-on.
- b) An appropriate NCF control message shall be sent, commanding the MES to transmit its identification code.
- c) The message sent by the MES shall be analysed.

### 5.2.6.3 Test requirements

The MES identification code in the message sent in step c) shall be verified against that supplied by the applicant for the MES.



~~The environmental test conditions are given in subclause 5.1.~~

#### 5.2.5.3.2 Test procedure

The MES shall be situated in an environment where receipt of the appropriate network control channel(s) is controlled by the test ~~laboratory~~.

- a) The MES shall be in a power-off state, situated such that it is not in receipt of a network control channel.
- b) The MES shall be powered-on.
- c) An attempt shall be made, using normal user operational procedures, to initiate a call.
- d) A network control channel shall be activated and a call shall be initiated using normal user operational procedures.
- e) The network control channel shall then be deactivated.
- f) An attempt shall be made, using normal user operational procedures, to initiate a call.
- g) The network control channel shall be reactivated and a call shall be initiated using normal user operational procedures.

Throughout this procedure, the transmission state of the MES shall be monitored.

#### 5.2.5.3.3 Test requirement

During and after test procedure step a), the MES shall be in power-off state.

During and after test procedure step b), no transmissions shall occur (carrier-off).

During and after test procedure step c), no transmissions shall occur (carrier-off).

After test procedure step d), the MES shall be transmitting (carrier-on).

Within 30 seconds of test procedure step e), MES transmissions shall cease (carrier-off).

During and after test procedure step f), no transmissions shall occur (carrier-off).

After test procedure step g), the MES shall be transmitting (carrier-on).

#### 5.2.5.4 Network control reception

##### 5.2.5.4.1 Transmit frequency control

###### 5.2.5.4.1.1 Method of test

The nominated bandwidth of the MES shall be monitored relative to the carrier frequency commanded, and relative to the operational frequency bands for the MES specified by the applicant.

The environmental test conditions are given in ~~subclause~~ 5.1.

###### 5.2.5.4.1.2 Test procedure

This test shall be carried out at least twice, once for the minimum and once for the maximum MES transmit frequency for which the MES is designed to operate, as specified by the applicant.

Where available, two additional transmit frequencies shall also be tested. These frequencies shall be equally spaced between the minimum and maximum frequencies. The commanded transmit frequencies used for the test shall be entered in the test report.

## Annex A (normative):

### HS Requirements and conformance Test specifications

#### Table (HS-RTT)

The HS Requirements and conformance Test specifications Table (HS-RTT) in table A 1 serves a number of purposes, as follows:

- it provides a statement of all the requirements in words and by cross reference to (a) specific clause(s) in the present document or to (a) specific clause(s) in (a) specific referenced document(s);
- it provides a statement of all the test procedures corresponding to those requirements by cross reference to (a) specific clause(s) in the present document or to (a) specific clause(s) in (a) specific referenced document(s);
- it qualifies each requirement to be either:
  - Unconditional: meaning that the requirement applies in all circumstances; or
  - Conditional: meaning that the requirement is dependant on the manufacturer having chosen to support optional functionality defined within the schedule.
- in the case of Conditional requirements, it associates the requirement with the particular optional service or functionality;
- it qualifies each test procedure to be either:
  - Essential: meaning that it is included with the Essential Radio Test Suite and therefore the requirement shall be demonstrated to be met in accordance with the referenced procedures;
  - Other: meaning that the test procedure is illustrative but other means of demonstrating compliance with the requirement are permitted.

**Table A 1- HS Requirements and conformance Test specifications Table (HS-RTT)**

<b><u>Harmonized Standard EN 301 442</u></b>						
<u>The following requirements and test specifications are relevant to the presumption of conformity under the article 3.2 of the R&amp;TTE Directive</u>						
<b><u>Requirement</u></b>			<b><u>Requirement Conditionality</u></b>		<b><u>Test Specification</u></b>	
<b><u>No</u></b>	<b><u>Description</u></b>	<b><u>Reference: Clause No</u></b>	<b><u>I/C</u></b>	<b><u>Condition</u></b>	<b><u>E/O</u></b>	<b><u>Reference: Clause No</u></b>
<u>1</u>	<u>Unwanted emissions outside the band 1 980,1 MHz to 2 009,9 MHz</u>	<u>4.2.1</u>	<u>U</u>			
<u>2</u>	<u>Unwanted emissions within the bands 1 980,1 MHz to 2 009,9 MHz, 1 978,1 MHz to 1 980,1 MHz and 2 009,9 MHz to 2 011,9 MHz</u>	<u>4.2.2</u>	<u>U</u>			
<u>3</u>	<u>Unwanted emissions in carrier-off state</u>	<u>4.2.3</u>	<u>U</u>			
<u>4</u>	<u>Self monitoring functions / Processor monitoring</u>	<u>4.2.4.1</u>	<u>U</u>			
<u>5</u>	<u>Self monitoring functions / Transmit frequency generation subsystem monitoring</u>	<u>4.2.4.2</u>	<u>U</u>			
<u>6</u>	<u>Network control authorization</u>	<u>4.2.4.3</u>	<u>U</u>			
<u>7</u>	<u>Transmit frequency control</u>	<u>4.2.4.4</u>	<u>U</u>			

The MES shall be situated in an environment where receipt of a network control channel and of NCF commands is controlled by the test ~~laboratory~~.

- a) A network control channel shall be activated and the MES powered-on.
- b) An appropriate NCF control message shall be sent, commanding the MES to set its carrier frequency to one of the transmit frequencies to be tested.
- c) The test shall be repeated for the other transmit frequencies to be tested.

The carrier mask for the transmit frequency under test shall be monitored on a spectrum analyzer, using the procedures given in ~~subclause~~ 5.2.3.1.

#### 5.2.5.4.1.3 Test requirement

The MES shall set the centre frequency of its transmission according to the NCF command.

The entire nominated bandwidth for each transmit frequency tested shall be contained completely within the operational frequency band(s) specified by the applicant.

### 5.2.5.5 Fellow radio stations in a dual-mode or multi-mode terminal

#### 5.2.5.5.1 Method of test

The MES shall be placed in a suitable environment which isolates the MES from the networks of its fellow modes. It shall be verified that no transmissions are made from that mode.

#### 5.2.5.5.2 Test procedure

The MES shall be placed in an environment where the receipt of network control channel(s) of supporting networks of the fellow modes is prevented. For each fellow mode radio station, an attempt shall be made, using normal user operational procedures, to initiate a call. Throughout this procedure, the transmission state of the MES shall be monitored.

#### 5.2.5.5.3 Test requirements

Throughout the test procedure, no transmission shall occur.

## 5.2.6 Equipment identity

### 5.2.6.1 Method of test

It is impracticable to test that each MES has a unique MES Identification Code (MIC) within its S-PCN, and that it is not possible for the user to alter the MIC using any normally accessible procedure. Consequently, no tests are given for these requirements.

The transmissions of the MES in response to an NCF command to send its identification code shall be monitored and the identification code received shall be verified.

The environmental test conditions are given in ~~subclause 5.1~~.

<b>Harmonized Standard EN 301 442</b>						
<u>The following requirements and test specifications are relevant to the presumption of conformity under the article 3.2 of the R&amp;TTE Directive</u>						
<b>Requirement</b>			<b>Requirement Conditionality</b>		<b>Test Specification</b>	
<b>No</b>	<b>Description</b>	<b>Reference: Clause No</b>	<b>U/C</b>	<b>Condition</b>	<b>E/O</b>	<b>Reference: Clause No</b>
8	Fellow radio stations in a dual-mode or multi-mode terminal	4.2.4.5	C	<u>Optional, may be provided. If provided it shall be implemented in accordance with the requirements</u>		
9	<u>Equipment identity</u>	4.2.5	U			

**Key to columns:****Requirement:**

**No** A unique identifier for one row of the table which may be used to identify a requirement or its test specification.

**Description** A textual reference to the requirement.

**Clause Number** Identification of clause(s) defining the requirement in the present document unless another document is referenced explicitly.

**Requirement Conditionality:**

**U/C** Indicates whether the requirement is to be *unconditionally* applicable (U) or is *conditional* upon the manufacturers claimed functionality of the equipment (C).

**Condition** Explains the conditions when the requirement shall or shall not be applicable for a technical requirement which is classified "conditional".

**Test Specification:**

**E/O** Indicates whether the test specification forms part of the Essential Radio Test Suite (E) or whether it is one of the Other Test Suite (O).

**NOTE:** All tests whether "E" or "O" are relevant to the requirements. Rows designated "E" collectively make up the Essential Radio Test Suite; those designated "O" make up the Other Test Suite; for those designated "X" there is no test specified corresponding to the requirement. The completion of all tests classified "E" as specified with satisfactory outcomes is a necessary condition for a presumption of conformity. Compliance with requirements associated with tests classified "O" or "X" is a necessary condition for presumption of conformity, although conformance with the requirement may be claimed by an equivalent test or by manufacturer's assertion supported by appropriate entries in the technical construction file.

**Clause Number** Identification of clause(s) defining the test specification in the present document unless another document is referenced explicitly. Where no test is specified (that is, where the previous field is "X") this field remains blank.

### 5.2.6.2 Test procedure

The MES shall be situated in an environment where receipt of a network control channel and of NCF commands is controlled by the test ~~laboratory~~.

- a) A network control channel shall be activated and the MES powered-on.
- b) An appropriate NCF control message shall be sent, commanding the MES to transmit its identification code.
- c) The message sent by the MES shall be analysed.

### 5.2.6.3 Test requirements

The MES identification code in the message sent in step c) shall be verified against that supplied by the applicant for the MES.

## Annex B (informative): Explanation of nominated bandwidth

### B.1 Introduction

This annex contains a graphical representation of the nominated bandwidth definition given in [clause 3.1](#).

### B.2 Interpretation of Parameters [ $B_n, f_c, a, b$ ]

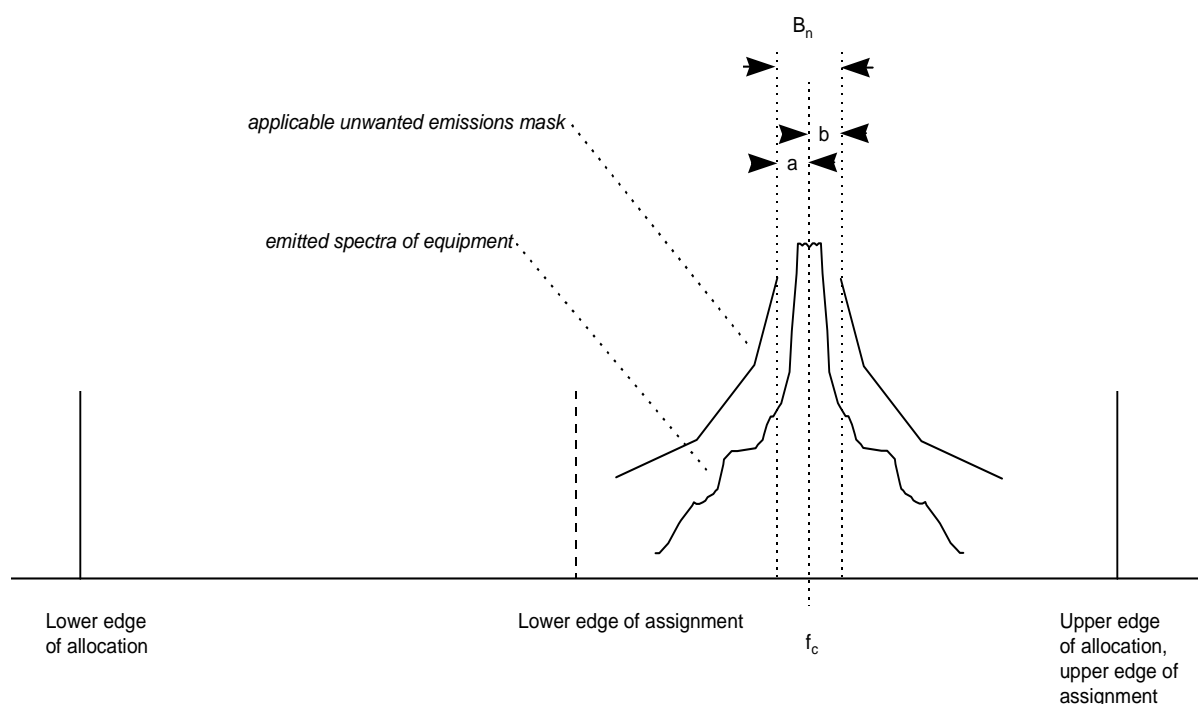

**Figure B.1: Nominated bandwidth and Unwanted Emissions Mask**

The centre frequency of the emitted spectra has been defined as  $f_c$ ; the values of  $a$  and  $b$  define the *nominated bandwidth*  $B_n$ . The value of  $B_n$  is chosen, such that the unwanted emissions mask is not exceeded by the emitted spectra - in this example, it can be seen that the nominated bandwidth could be reduced without exceeding the limits of the mask.

### B.3 Choice of nominated bandwidth

The choice of the nominated bandwidth is made by the applicant according to the bandwidth and shape of the spectral emission of the equipment. The optimum choice of nominated bandwidth will maximize the available operating frequency range of the MES, and this is achieved by selecting nominated bandwidth as narrow as possible without exceeding the applicable unwanted emissions masks. To illustrate this, two examples are given in figure B.2. The figures show occupied channels represented by carrier frequency ( $f_1, f_2$ ) and the unwanted emission mask.

## ~~Annex A (normative): The EN Requirements Table (EN-RT)~~

~~Notwithstanding the provisions of the copyright clause related to the text of the present document, ETSI grants that users of the present document may freely reproduce the EN-RT proforma in this annex so that it can be used for its intended purposes and may further publish the completed EN-RT.~~

~~The EN Requirements Table (EN-RT) serves a number of purposes, as follows:~~

- ~~it provides a tabular summary of all the requirements;~~
- ~~it shows the status of each EN Requirement, whether it is essential to implement in all circumstances (Mandatory), or whether the requirement is dependent on the applicant having chosen to support a particular optional service or functionality (Optional). In particular it enables the EN-Requirements associated with a particular optional service or functionality to be grouped and identified;~~
- ~~when completed in respect of a particular equipment it provides a means to undertake the static assessment of conformity with the EN.~~

~~The EN-RT is placed in an annex of the EN in order that it may be photocopied and used as a proforma.~~

**Table A.1. EN Requirements Table (EN-RT)**

EN Reference		EN 301 442			Comments
No.	Reference	EN-R (note)	Status		
1	4.2.1	Unwanted emissions outside the band 1 980,1 MHz to 2 009,9 MHz	M		
2	4.2.2	Unwanted emissions within the bands 1 980,1 MHz to 2 009,9 MHz, 1 978,1 MHz to 1 980,1 MHz and 2 009,9 MHz to 2 011,9 MHz	M		
3	4.2.3	<del>Unwanted emissions in carrier-off state</del>	M		
4	4.2.4.1	<del>Self monitoring functions / Processor monitoring</del>	M		
5	4.2.4.2	Self monitoring functions / Transmit frequency generation subsystem monitoring	M		
6	4.2.4.3	<del>Network control authorization</del>	M		
7	4.2.4.4	<del>Transmit frequency control</del>	M		
8	4.2.4.5	Fellow radio stations in a dual-mode or multi-mode terminal	⊖		
9	4.2.5	Equipment identity	M		

~~NOTE: These EN Requirements are justified under Article 3.2 of the R&TTE Directive.~~

### ~~Key to columns:~~

- ~~**No** Table entry number;~~
- ~~**Reference** Subclause reference number of conformance requirement within the present document;~~
- ~~**EN-R** Title of conformance requirement within the present document;~~
- ~~**Status** Status of the entry as follows:~~
- ~~M Mandatory, shall be implemented under all circumstances;~~
  - ~~⊖ Optional, may be provided, but if provided shall be implemented in accordance with the requirements;~~
- ~~**Comments** To be completed as required.~~

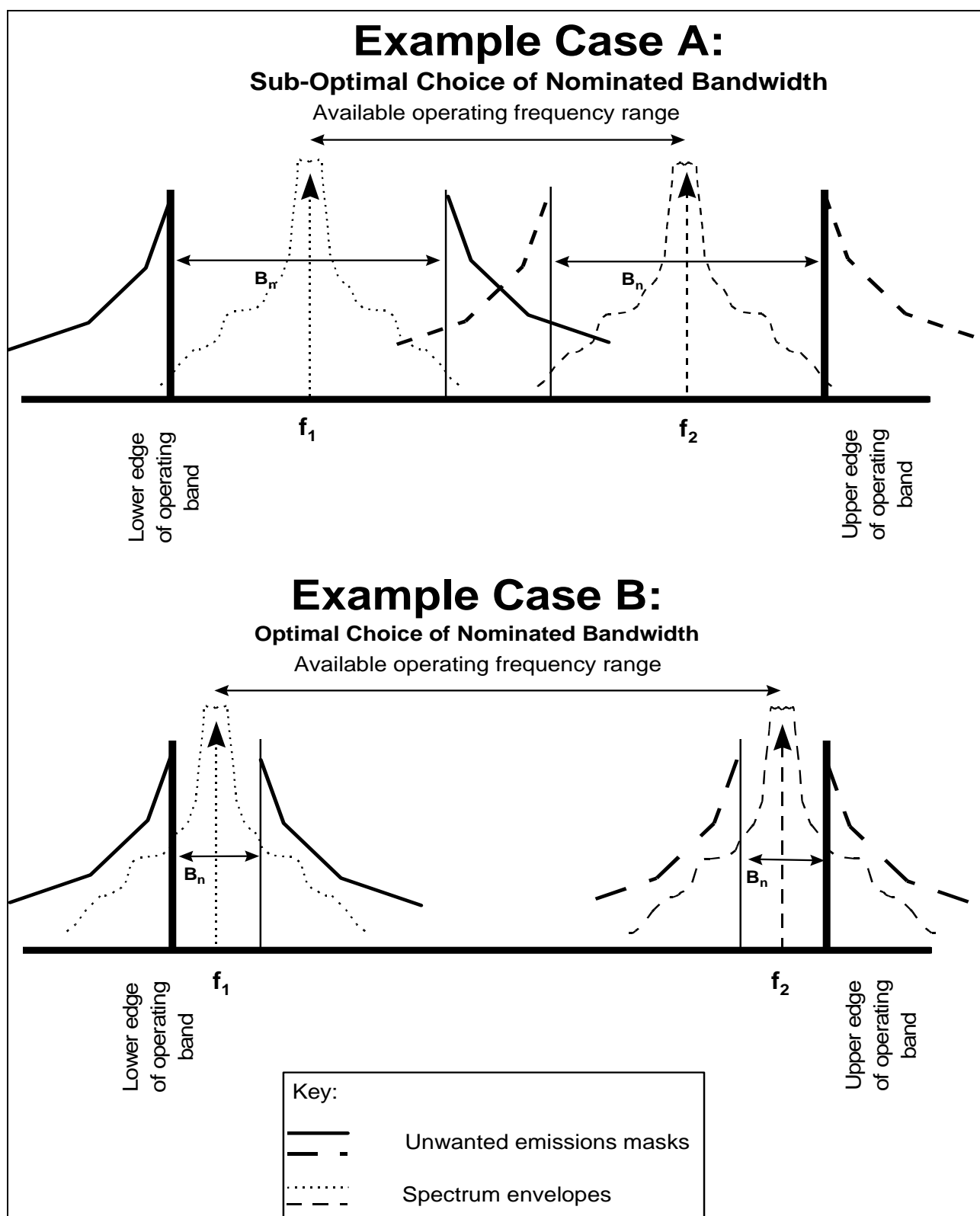

**Figure B.2: Choice of nominated bandwidth**

In case A, the lower carrier (centre frequency  $f_1$ ) is shown operating at its lowest allowable frequency, with the nominated bandwidth adjacent to the edge of the assignment. Similarly, the upper carrier is shown in the highest allowable frequency, centre frequency  $f_2$ . The available tuning range for the carrier is shown.

In case B, a similar situation is shown, but with a smaller nominated bandwidth. The uppermost and lowermost channels are operating closer to the band edges, and thus the available tuning range is greater.



## Annex B (informative): Explanation of nominated bandwidth

### B.1 Introduction

This annex contains a graphical representation of the nominated bandwidth definition given in ~~subclause 3.1~~

### B.2 Interpretation of Parameters [ $B_n, f_c, a, b$ ]

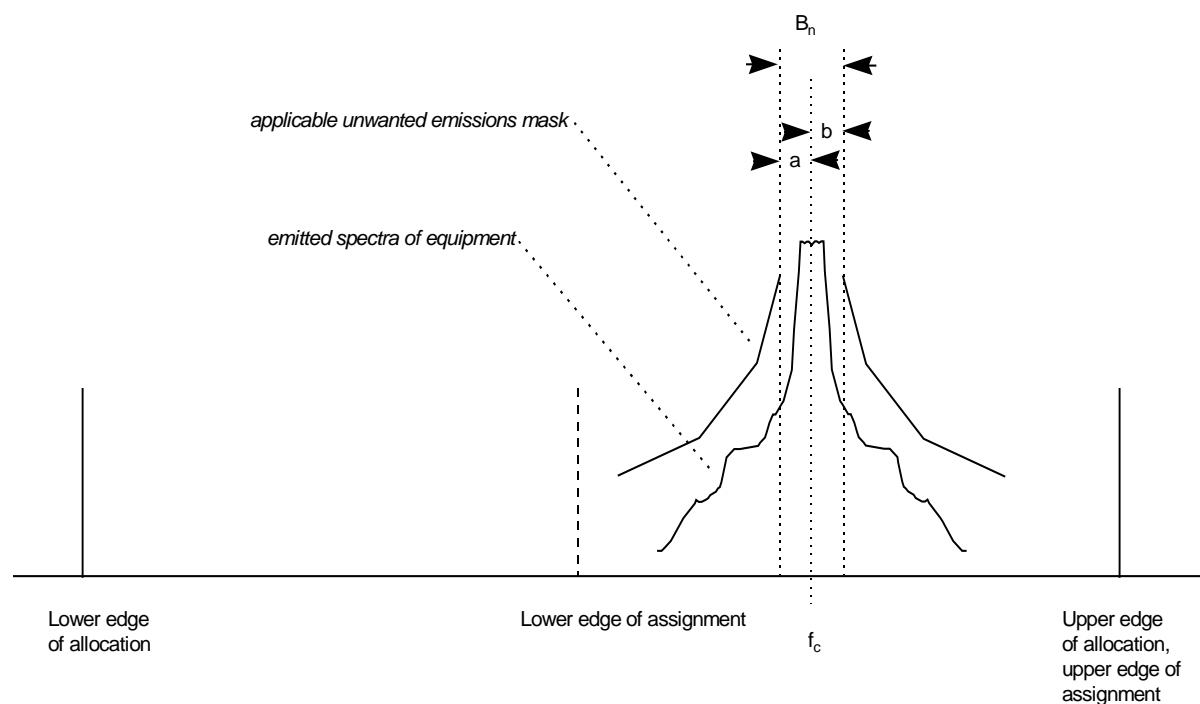

**Figure B.1: Nominated bandwidth and Unwanted Emissions Mask**

The centre frequency of the emitted spectra has been defined as  $f_c$ ; the values of  $a$  and  $b$  define the *nominated bandwidth*  $B_n$ . The value of  $B_n$  is chosen, such that the unwanted emissions mask is not exceeded by the emitted spectra - in this example, it can be seen that the nominated bandwidth could be reduced without exceeding the limits of the mask.

### B.3 Choice of nominated bandwidth

The choice of the nominated bandwidth is made by the applicant according to the bandwidth and shape of the spectral emission of the equipment. The optimum choice of nominated bandwidth will maximize the available operating frequency range of the MES, and this is achieved by selecting nominated bandwidth as narrow as possible without exceeding the applicable unwanted emissions masks. To illustrate this, two examples are given in figure B.2. The figures show occupied channels represented by carrier frequency ( $f_1, f_2$ ) and the unwanted emission mask.

## B.4 Maximum value for nominated bandwidth

The maximum value for the nominated bandwidth ( $B_n$ ) is defined in [clause 3.1](#) so that the frequency interval ( $f_c - a, f_c + b$ ) shall not encompass more than either:

- i) when  $a = b$ , 4 nominal carrier frequencies (i.e. five channel spacing) for narrow-band systems;
- ii) when  $a \neq b$ , 1 nominal carrier frequency (i.e. two channel spacing) for narrow-band systems; or
- iii) 1 nominal carrier frequency (i.e. two channel spacing) for wide-band systems.

NOTE: In the following diagrams,  $f_c$  represents the actual frequency of transmission.

For case (i), the maximum value for the value of  $B_n$  is thus:

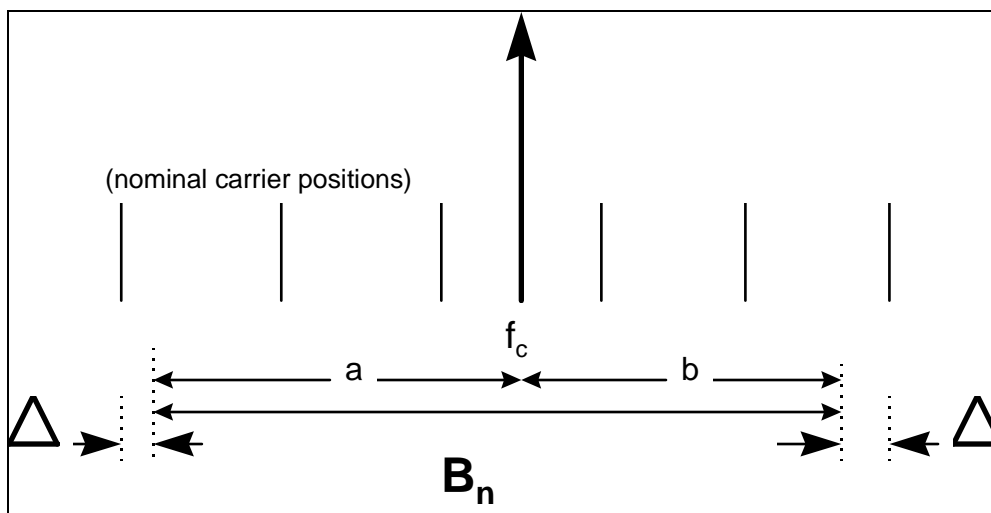

Figure B.3: Maximum value of nominated bandwidth for Case (i)

(When  $\Delta$  is very small,  $B_n$  approaches 5 channel spacing and contains only 4 nominal carriers).

For case (ii), the maximum value for the value of  $B_n$  is thus:

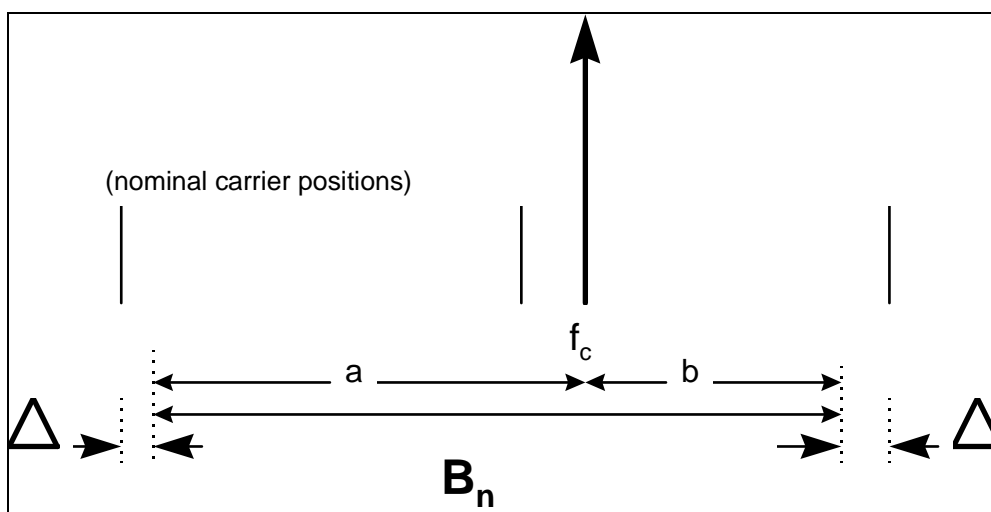
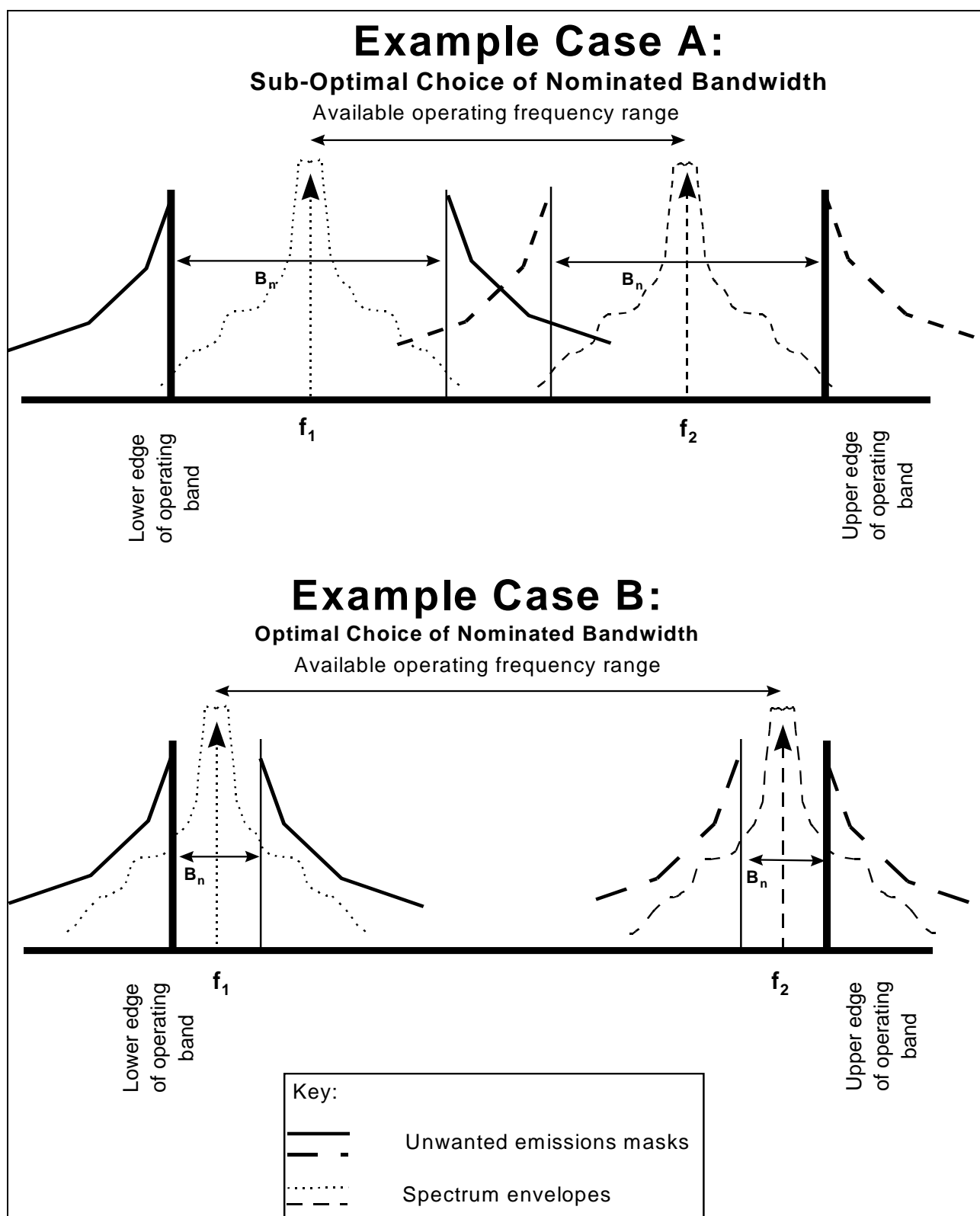

Figure B.4: Maximum value of nominated bandwidth for Case (ii)

(When  $\Delta$  is very small,  $B_n$  approaches 2 channel spacing and contains only 1 nominal carrier).

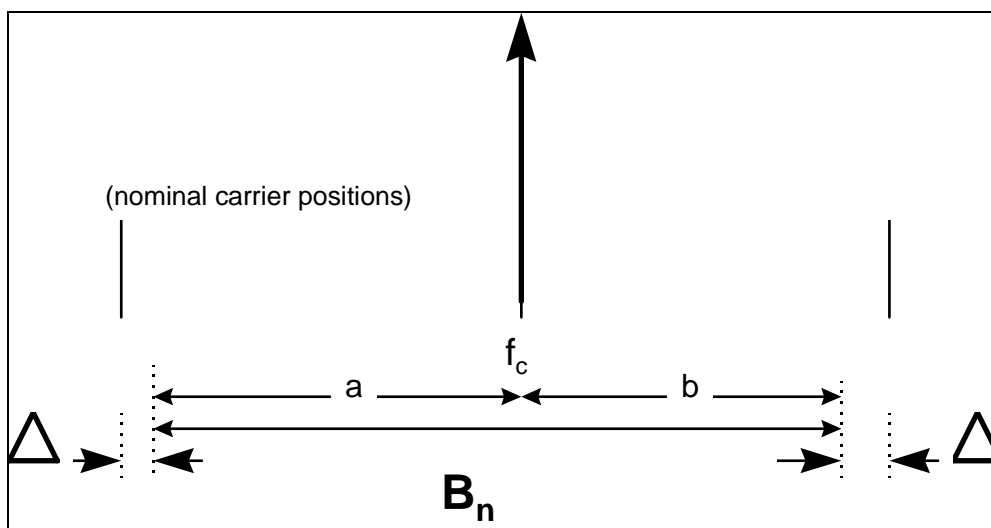

**Figure B.2: Choice of nominated bandwidth**

In case A, the lower carrier (centre frequency  $f_1$ ) is shown operating at its lowest allowable frequency, with the nominated bandwidth adjacent to the edge of the assignment. Similarly, the upper carrier is shown in the highest allowable frequency, centre frequency  $f_2$ . The available tuning range for the carrier is shown.

In case B, a similar situation is shown, but with a smaller nominated bandwidth. The uppermost and lowermost channels are operating closer to the band edges, and thus the available tuning range is greater.

For case (iii), where the values of  $a$  and  $b$  are equal, the maximum value for the value of  $B_n$  is thus:



**Figure B.5: Maximum value of nominated bandwidth for Case (iii)**

(When  $\Delta$  is very small,  $B_n$  approaches 2 channel spacing and contains only 1 nominal carrier).

For case (iii), where the values of  $a$  and  $b$  are not equal, the maximum value for the value of  $B_n$  is thus:

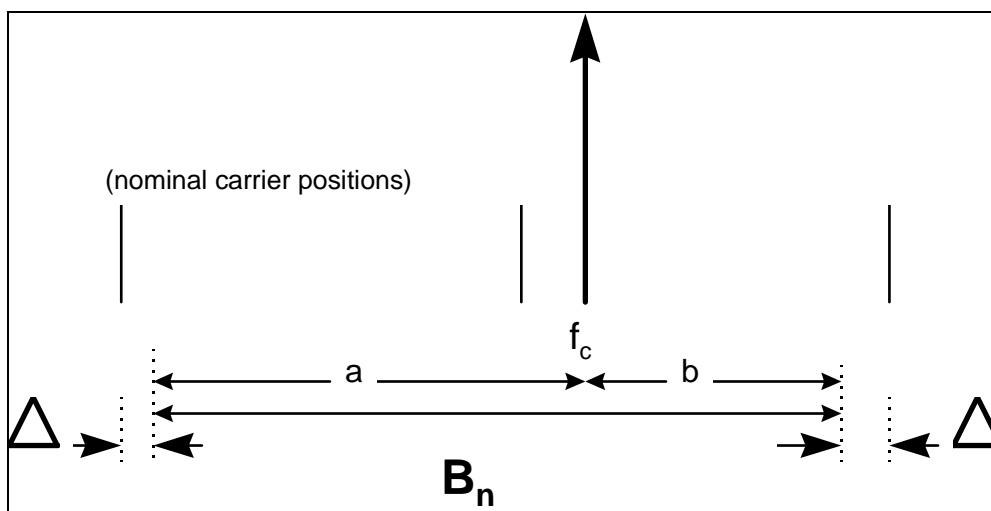

**Figure B.6: Maximum value of nominated bandwidth for Case (iii)**

(When  $\Delta$  is very small,  $B_n$  approaches 2 channel spacing and contains only 1 nominal carrier).

## B.4 Maximum value for nominated bandwidth

The maximum value for the nominated bandwidth ( $B_n$ ) is defined in ~~subclause~~ 3.1 so that the frequency interval ( $f_c - a, f_c + b$ ) shall not encompass more than either:

- i) when  $a = b$ , 4 nominal carrier frequencies (i.e. five channel spacing) for narrow-band systems;
- ii) when  $a \neq b$ , 1 nominal carrier frequency (i.e. two channel spacing) for narrow-band systems; or
- iii) 1 nominal carrier frequency (i.e. two channel spacing) for wide-band systems.

NOTE: In the following diagrams,  $f_c$  represents the actual frequency of transmission.

For case (i), the maximum value for the value of  $B_n$  is thus:

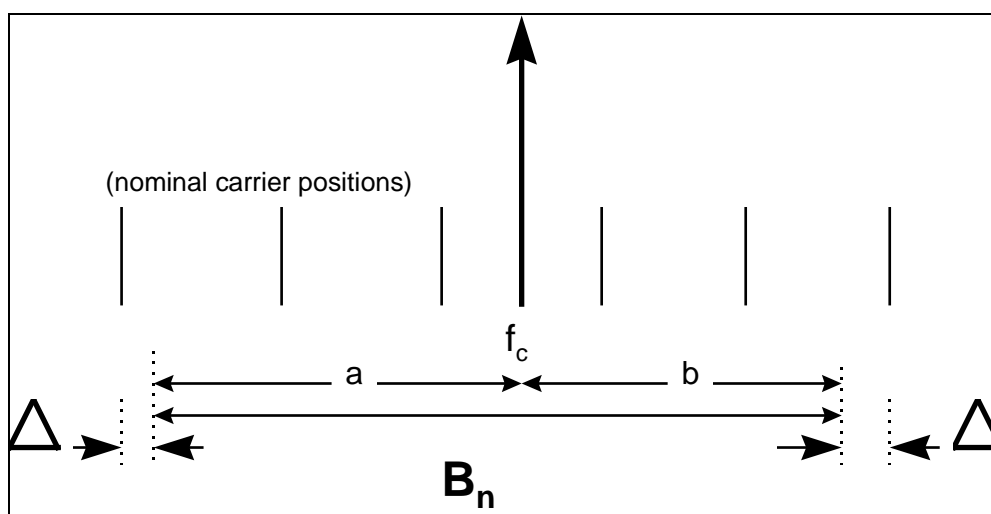

Figure B.3: Maximum value of nominated bandwidth for Case (i)

(When  $\Delta$  is very small,  $B_n$  approaches 5 channel spacing and contains only 4 nominal carriers).

For case (ii), the maximum value for the value of  $B_n$  is thus:

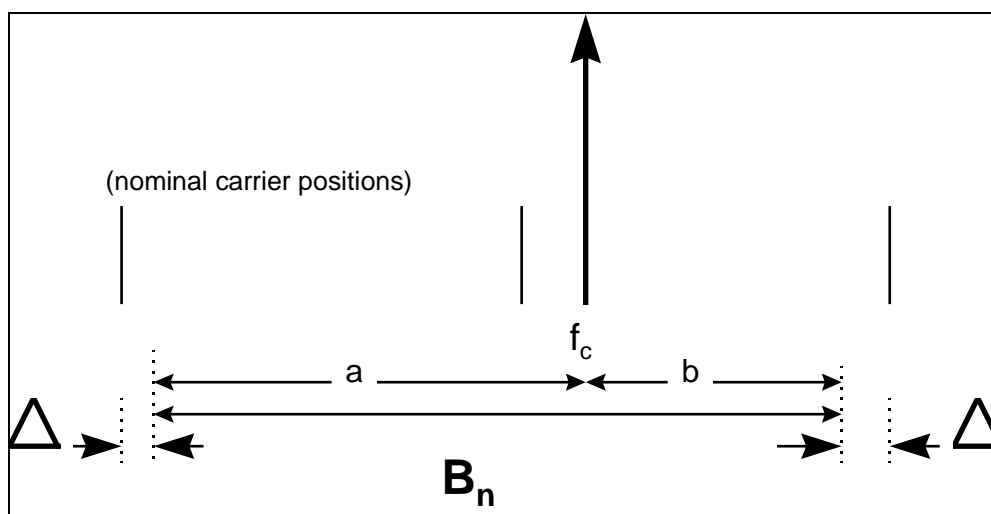

Figure B.4: Maximum value of nominated bandwidth for Case (ii)

(When  $\Delta$  is very small,  $B_n$  approaches 2 channel spacing and contains only 1 nominal carrier).

---

## Annex C (informative): The EN title in the official languages

The enlargement of the European Union (EU) resulted in a requirement from the EU for a larger number of languages for the translation of the titles of Harmonized Standards and mandated ENs that are to be listed in the Official Journal to support the implementation of this legislation.

For this reason the title translation concerning the present document can be consulted via the [e-approval](#) application.

For case (iii), where the values of  $a$  and  $b$  are equal, the maximum value for the value of  $B_n$  is thus:

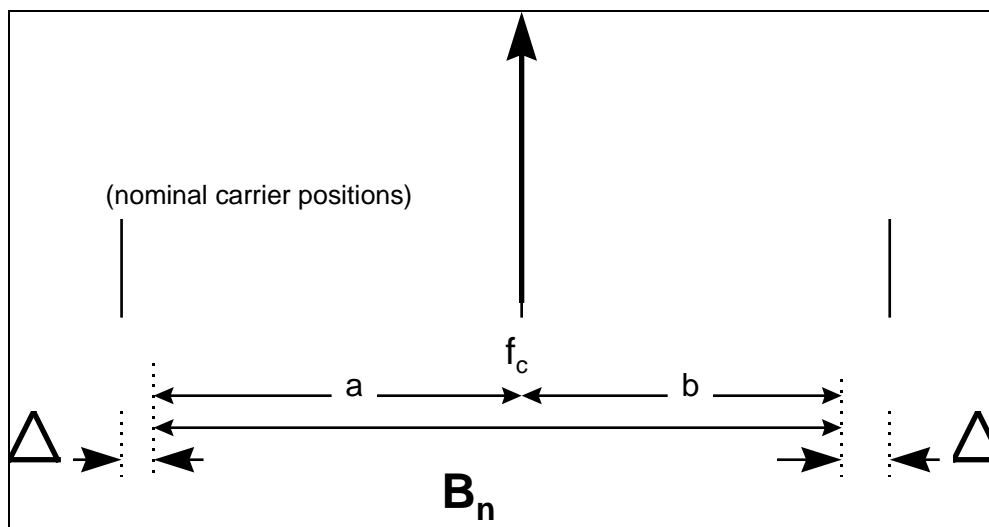

**Figure B.5: Maximum value of nominated bandwidth for Case (iii)**

(When  $\Delta$  is very small,  $B_n$  approaches 2 channel spacing and contains only 1 nominal carrier).

For case (iii), where the values of  $a$  and  $b$  are not equal, the maximum value for the value of  $B_n$  is thus:

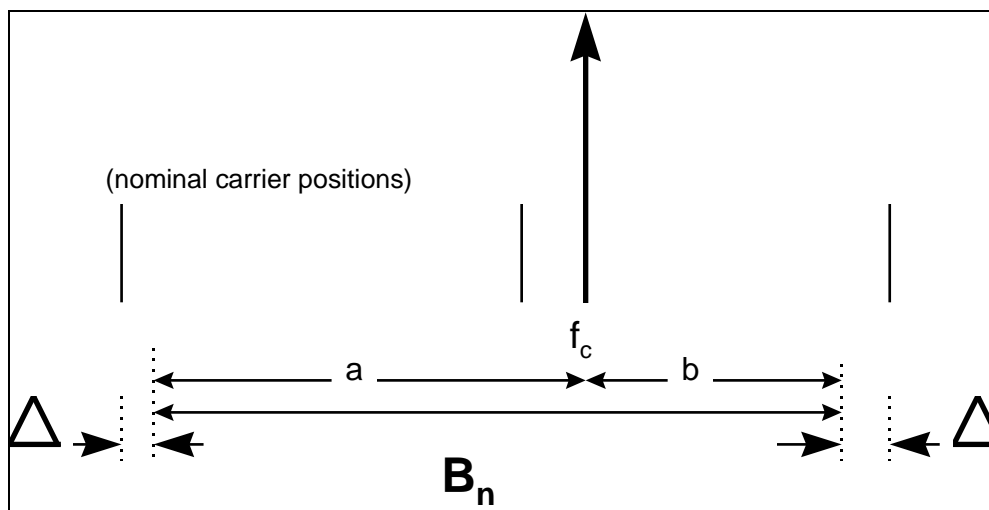

**Figure B.6: Maximum value of nominated bandwidth for Case (iii)**

(When  $\Delta$  is very small,  $B_n$  approaches 2 channel spacing and contains only 1 nominal carrier).

---

## Annex D (informative): Bibliography

- ETSI EN 300 831: "Electromagnetic compatibility and Radio spectrum Matters (ERM): Electromagnetic Compatibility (EMC) for Mobile Earth Stations (MES) used within Satellite Personal Communications Networks (S-PCN) operating in the 1,5/1,6/2,4 GHz and 2 GHz frequency bands"
- CENELEC EN 55022: "Limits and methods of measurement of radio disturbance characteristics of information technology equipment".
- Construction of an Anechoic Chamber: Technical Report ZVEI AK-R 90/20.
- ETSI TBR 042 (April 2000): "Satellite Personal Communications Networks (S-PCN): Mobile Earth Stations (MES) including handheld earth stations for S-PCN in the 2.0 GHz bands under the Mobile Satellite Service (MSS): Terminal essential requirements"
- ETSI ETS 300 735 (October 1997): "Satellite Personal Communications Networks (S-PCN): Network Control Facilities (NCF) for Mobile Earth Stations (MES) including handheld earth stations for S-PCN in the 1,6/2,4 GHz and the 2,0 GHz bands, providing voice and/or data communications under the Mobile Satellite Service (MSS)"



---

## ~~Bibliography~~

~~The following material, though not specifically referenced in the body of the present document (or not publicly available), gives supporting information:~~

- ~~ETS 300 831: "EMC spectrum & Radio Matters (ERM), Electromagnetic compatibility (EMC) for Mobile Earth Stations (MES) used with Satellite - Personal Communication Networks (S-PCN) operating in the 1,5/1,6/2,4 GHz and 2 GHz Frequency Bands".~~
- EN 55022: "Limits and methods of measurement of radio disturbance characteristics of information technology equipment".
- Construction of an Anechoic Chamber: Technical Report ZVEI AK-R 90/20.

## History

<b>Document history</b>				
<u>V1.1.1</u>	<u>May 2000</u>	<u>Publication</u>		
<u>V1.2.1</u>	<u>November 2008</u>	<u>Public Enquiry</u> <u>(Withdrawn)</u>	<u>PE 20090308:</u>	<u>2008-11-08 to 2009-03-09</u>
<u>V1.2.0</u>	<u>November 2009</u>	<u>Public Enquiry</u>	<u>PE 20100311:</u>	<u>2009-11-11 to 2010-03-11</u>
<u>V1.2.1</u>	<u>June 2010</u>	<u>Vote</u>	<u>V 20100801:</u>	<u>2010-06-02 to 2010-08-02</u>
<u>V1.2.1</u>	<u>August 2010</u>	<u>Publication</u>		

## ~~History~~

<del>Document history</del>		
<del>V1.1.1</del>	<del>December 1999</del>	<del>One step Approval Procedure      GAP 200017: 1999-12-29 to 2000-04-28</del>
<del>V1.1.1</del>	<del>May 2000</del>	<del>Publication</del>

